

STELLAx4

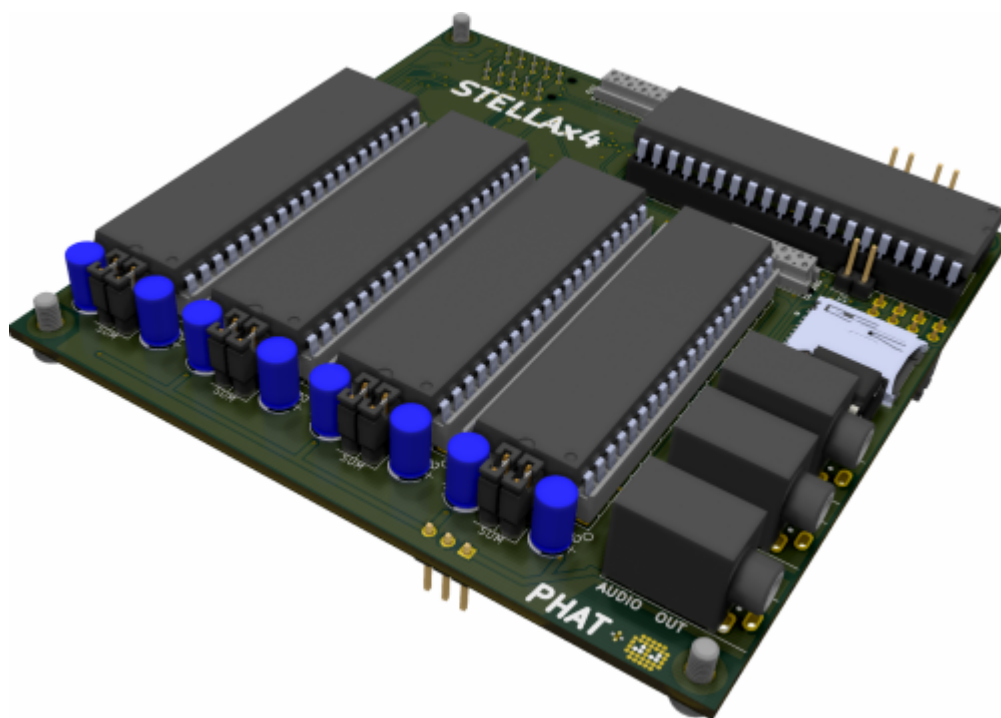

4x 8Bit Soundchips/TIAś on a 10x10cm PCB,

controlled from a STM32F4 Microcontroller [dipcoref4](#), based on [Antichambreś TIA Module](#), with [AD9833ś](#) as External programmable Clock, the Frequency-range is expandet...

The Board acts a Motherboard, for

- 4x Soundchip... AND:

also like the [stm32f4_module](#) it provides:

- Midi-IO - 1x IN, 1x OUT > 3,5Jacks/TRS
- μSD-Card - 2 Save Patches
- μController-Socket - 2 Plug the [dipcore_f4](#) in, ask [antichambre](#) to get one!
- J19>[AoutNG](#) - to connect VCF or VCAs...
- J8/9>[DOUT](#) & [DIN](#) - 4 the UI
- J15 (JLCD1) which handle from Stock 4x SPI-Displays (SSD1306), - 4 the UI
- J1>chain a nother STELLAx4 as "SLAVE" to it, to expand polyphony

ready for Pick and Place

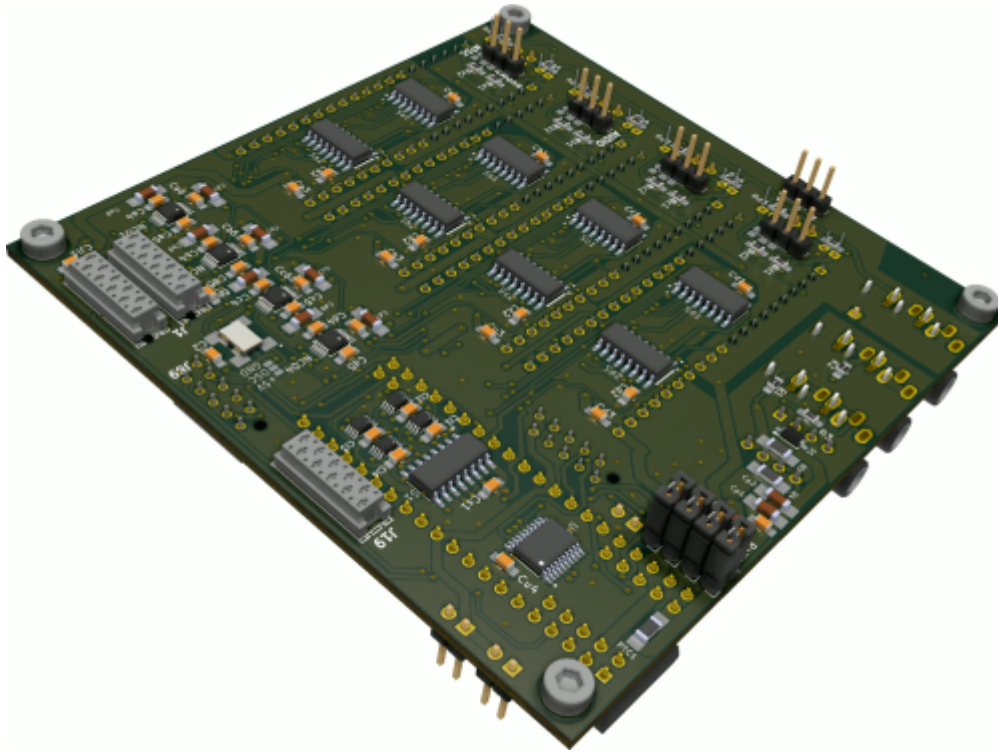

-all SMD-Parts are on one SIDE and are presoldered..

Features

- * Summed or Individual Audio-Outs, selectable via normal Jumpers
- * NTSC or PAL > select via SMD-Solder-Jumper
- * User-Interface is C-Language-Programmable

Hardware Requirements

- [dipcoref4](#)
- 4 x [TIA/STELLA](#) [PAL or NTSC...]
- Soldering Iron - with a Dip that can Handle Thruhole-Parts, solder Paste...
- 5V from Mini-USB-Plug, or 5V at a 2Pin-Header connected to example a Eurorack Power Source (+5VDC!)
- dont forget Midi TRS Cables

Schematic

Rev.A

[stellax4-schematic.pdf](#)

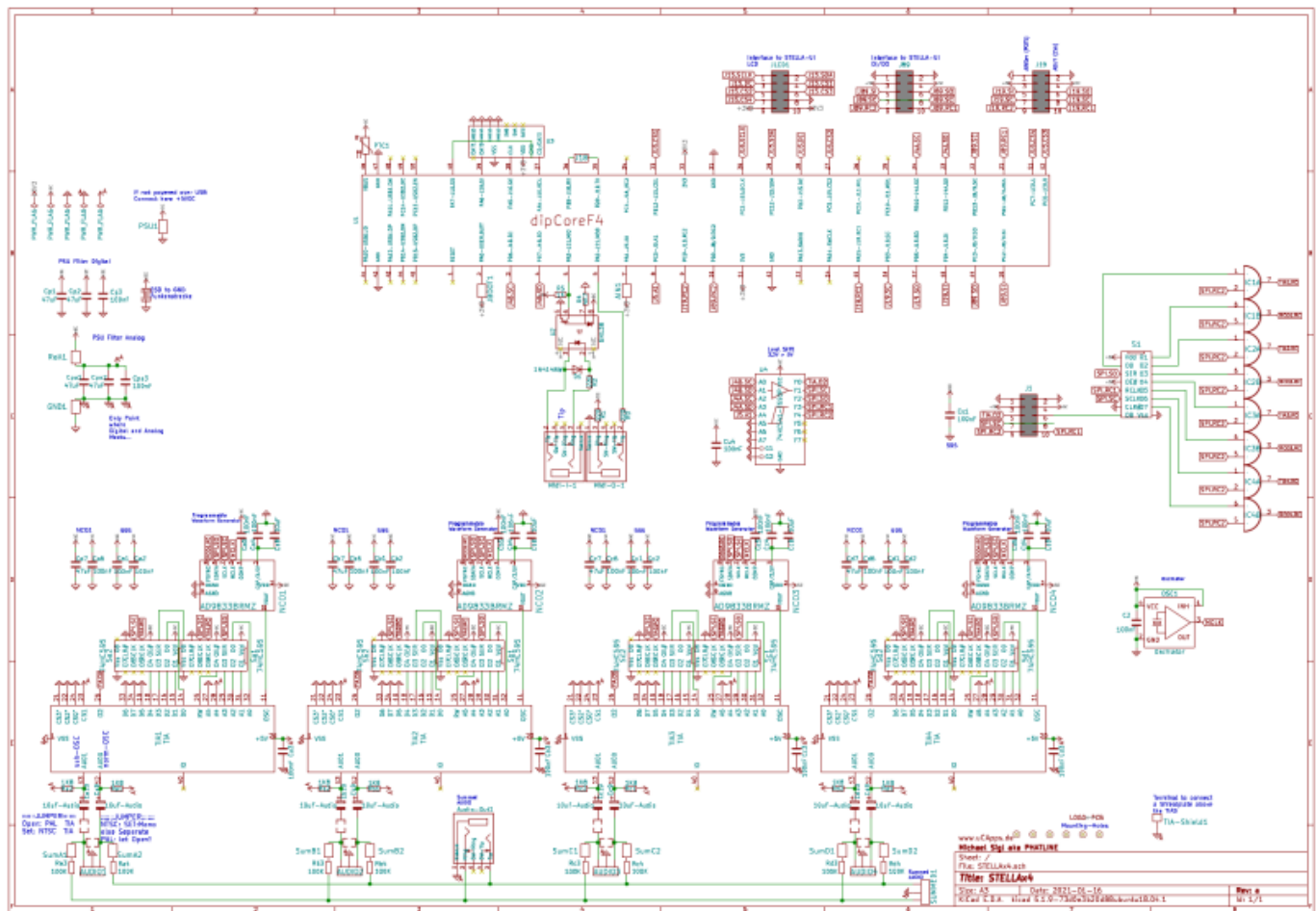

Rev.B
[stellax4-schematic-b.pdf](#)

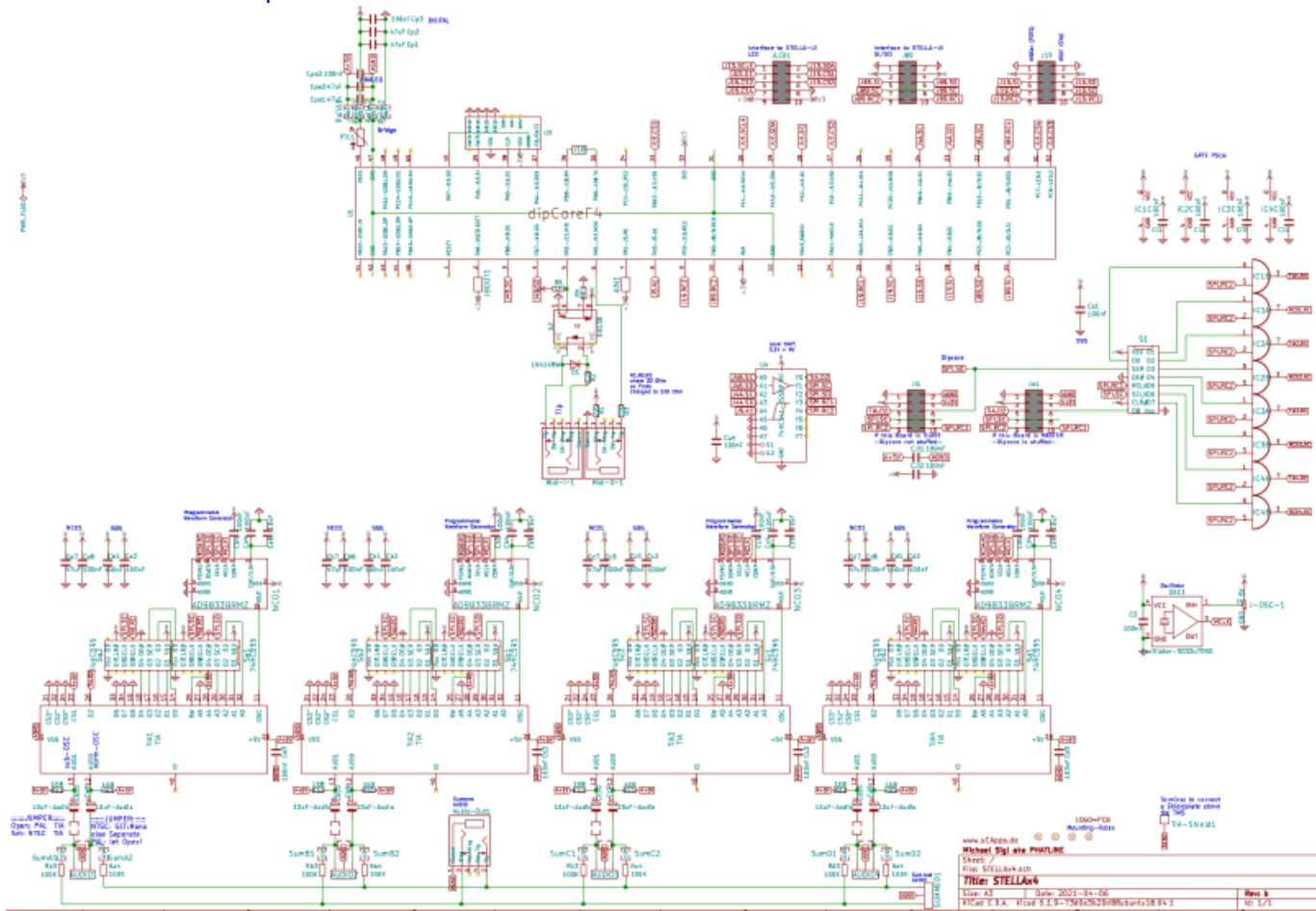

Building

The Design is optimized for Pick and Place > all SMD Parts are on the Top-PCB
The Rest is Thruhole > easy

Rev.A

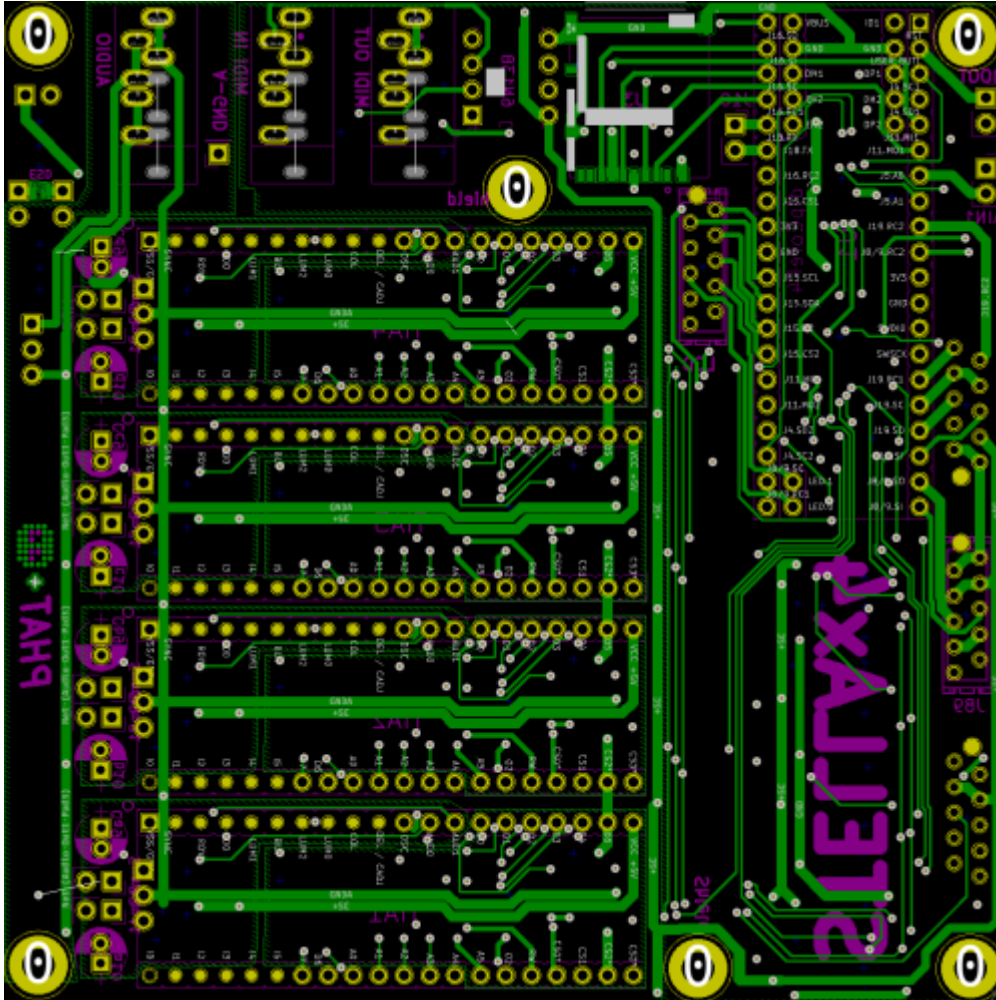

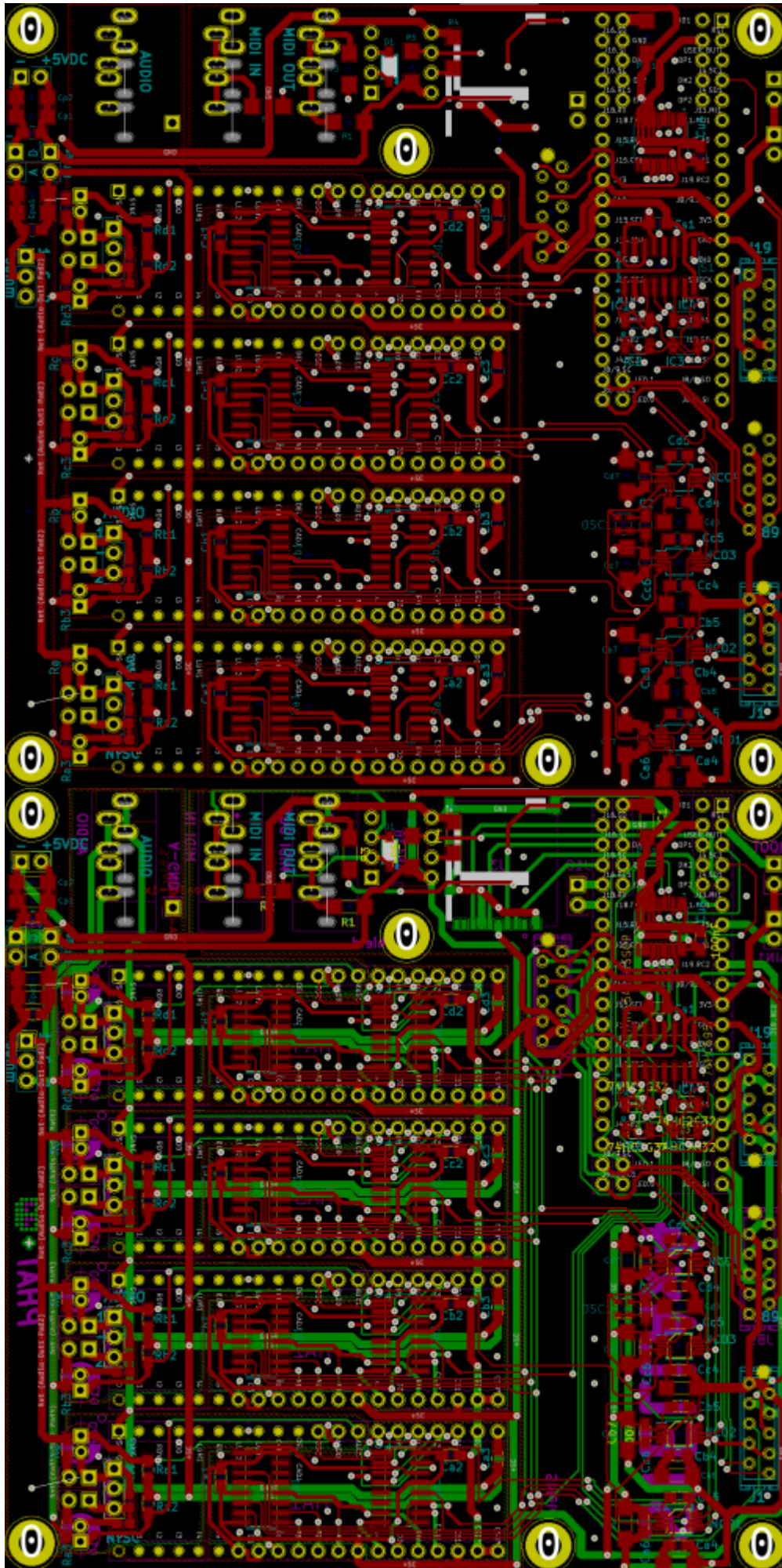

Rev.B

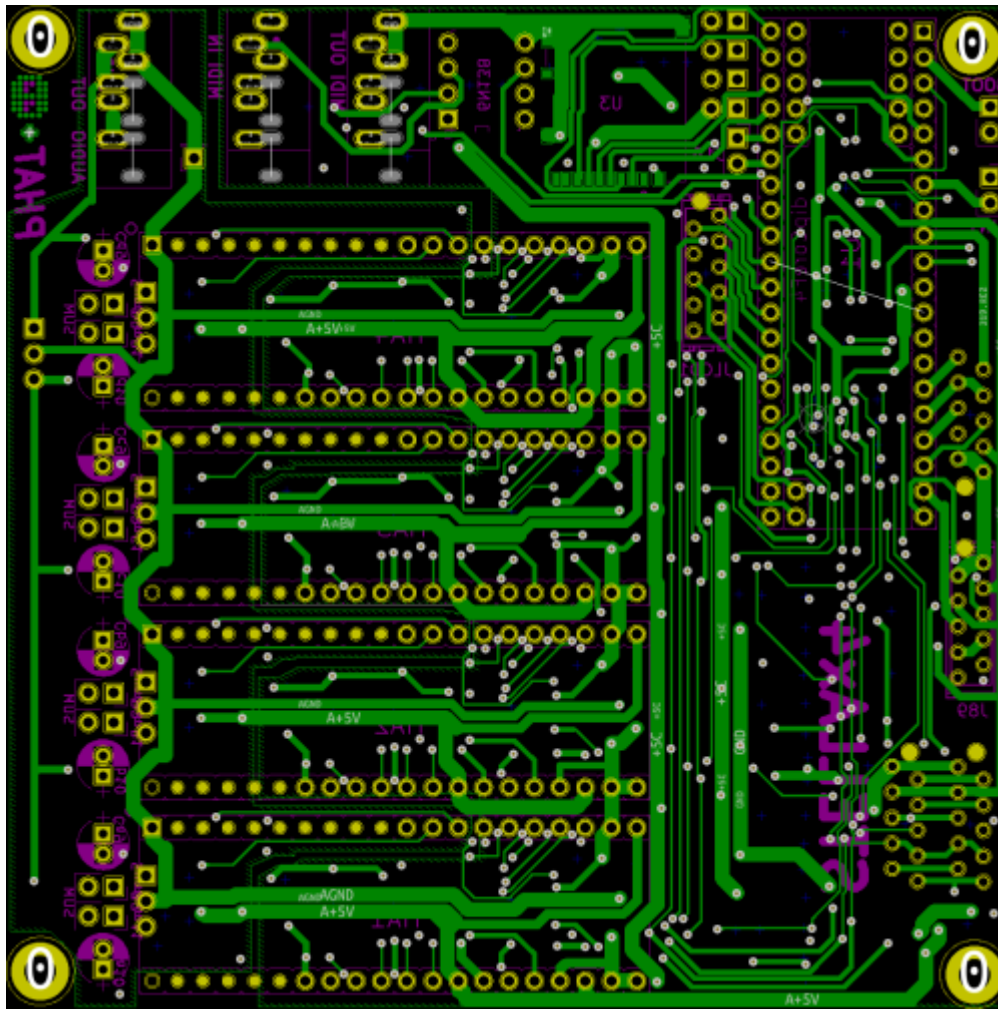

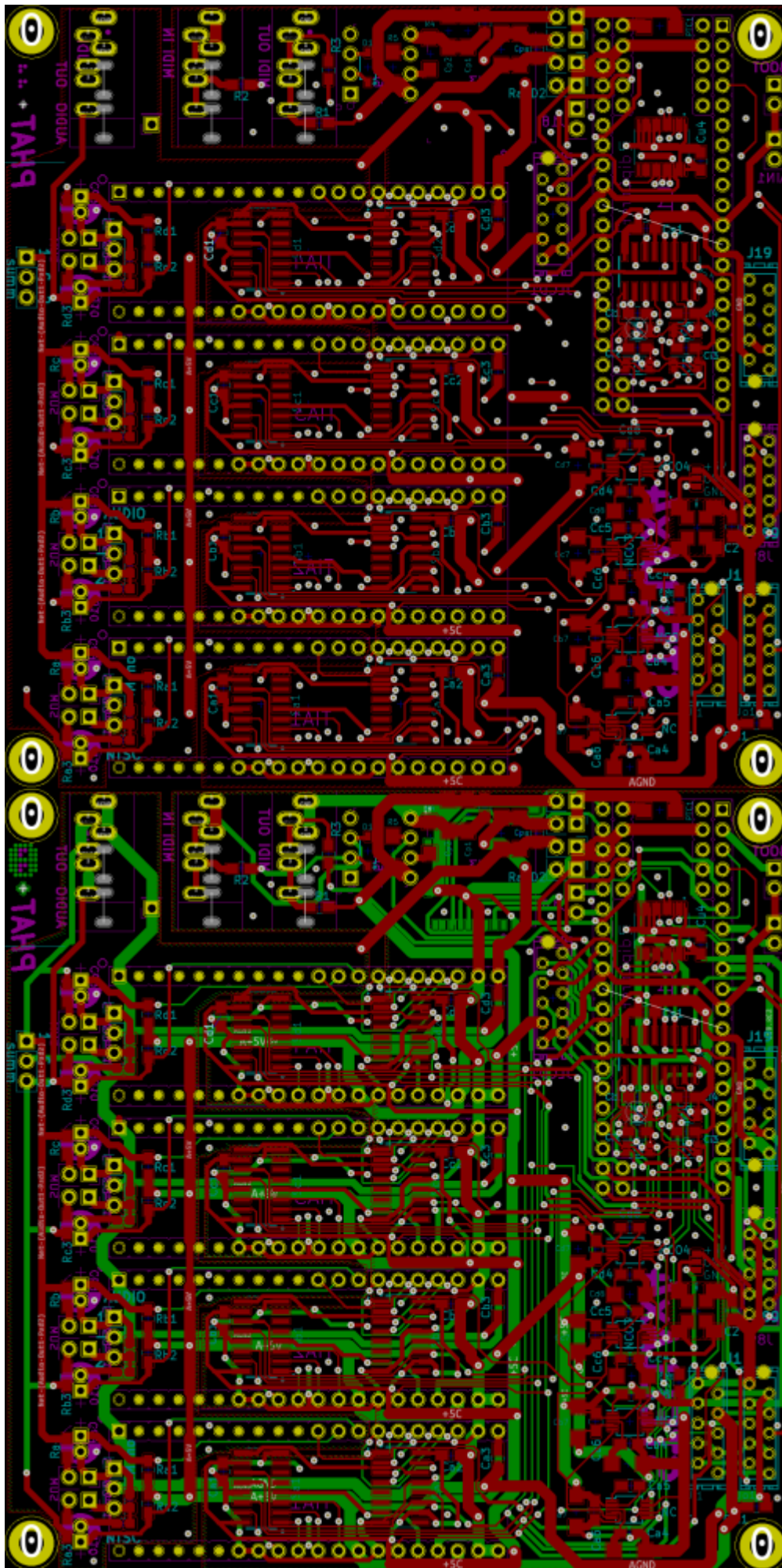

BOM LCSC

these are the parts which are presoldered by the Pick and Place Machine

Comment	Designator	Footprint	LCSC Part Number
100nF	Ca1,Cb1,Cc1,Cs1,Cd1,Ca2,Cb2,Cc2,C2,Cd2,Ca3,Cb3,Cc3,Cp3,Cpa3,Cd3,Ca4,Cb4,Cc4,Cd4,Cu4,Ca5,Cb5,Cc5,Cd5,Ca6,Cb6,Cc6,Cd6	0805	C49678
47uF	Cp1,Cpa1,Cp2,Cpa2,Ca7,Cb7,Cc7,Cd7	1206	C96123
10uF	Ca8,Cb8,Cc8,Cd8	1206	C13585
1N4148W	D1	SOD123	C81598
74HC2G32	IC1,IC2,IC3,IC4	VSSOP-8_2.3x2mm_P0.5mm	C91874
AD9833BRMZ	NCO1,NCO2,NCO3,NCO4	MSOP-10_3x3mm_P0.5mm	C9652
Oscillator	OSC1	25x20-4Pole-SMD	C90621
220	R1,R2,R3	1206	C17958
4K7	R4	1206	C17936
1K	R5	1206	C4410
1K8	Ra1,Rb1,Rc1,Rd1,Ra2,Rb2,Rc2,Rd2	0805	C17398
100K	"Ra3,Rb3,Rc3,Rd3,Ra4,Rb4,Rc4,Rd4"	0805	C17407
74HC595	Sa1,Sb1,Sc1,Sd1,S1,Sa2,Sb2,Sc2,Sd2	SOIC-16	C5947
74HC541-TSSOP	U4	TSSOP20	C406865

BOM Mouser

30,39€ exlc shipping > so better order other stuff too, over 50€ there is free shipping!

Parts for Handsolder:[copy list below, and paste in this link](#)

- 647-UFG1H100MDM|8
- 649-68000-220HLF|3
- 151-8010-E|10
- 571-1-2178710-0|4
- 490-SJ1-3535NG|3
- 575-1104764041001000|4
- 200-CES12001TS|3
- 512-6N138M|1
- 575-1104730841001000|1
- 798-DM3AT-SF-PEJM5|1
- 474-COM-15107|1

for prototyping i ordered:

490-SJ1-3535NG-GR instead of **490-SJ1-3535NG** because it is out of stock - so **GREEN sockets** for now!

Cable-Connectors for UserInterface and AOUT-Module you will need also:

- 571-1-2178712-0|8
- + Ribbon Cables for example:
- 710-63911015521CAB|1

Comment	Designator	Mouser Part Nr	
10uF-Audio	Ca9Cb9Cc9Cd9Ca10Cb10Cc10Cd10	647-UFG1H100MDM	8
220	R1R2R3	32	
3.5Jack	Midi-I-1Midi-O-1Audio-Out1	490-SJ1-3535NG	3
6N138	U2	512-6N138M & 575-1104730841001000	1

Comment	Designator	Mouser Part Nr	
DIPCOREF4_52P	U1	200-CES12001TS	3
Header-1x2-JUMPER	SumA-SumD2SumB2RailD2RailA2	649-68000-220HLF + 151-8010-E	12
Header-1x3	AUDIO1SUMMED1AUDIO2AUDIO3AUDIO4	649-68000-220HLF	1
Header-2x5-Micromatch	JLCD1,Jo1,ji1,J19,J89	571-1-2178710-0	5
Oscillator-5032u7050	OSC1	732-5032CC25.0HJGA3	1
PinHead-1x2	JBOOT1AIN1J18	649-68000-220HLF	1
TIA	TIA1TIA2TIA3TIA4	575-1104764041001000	4
uSD_DM3ATDM3AT	U3	798-DM3AT-SF-PEJM5	1

PART Locations

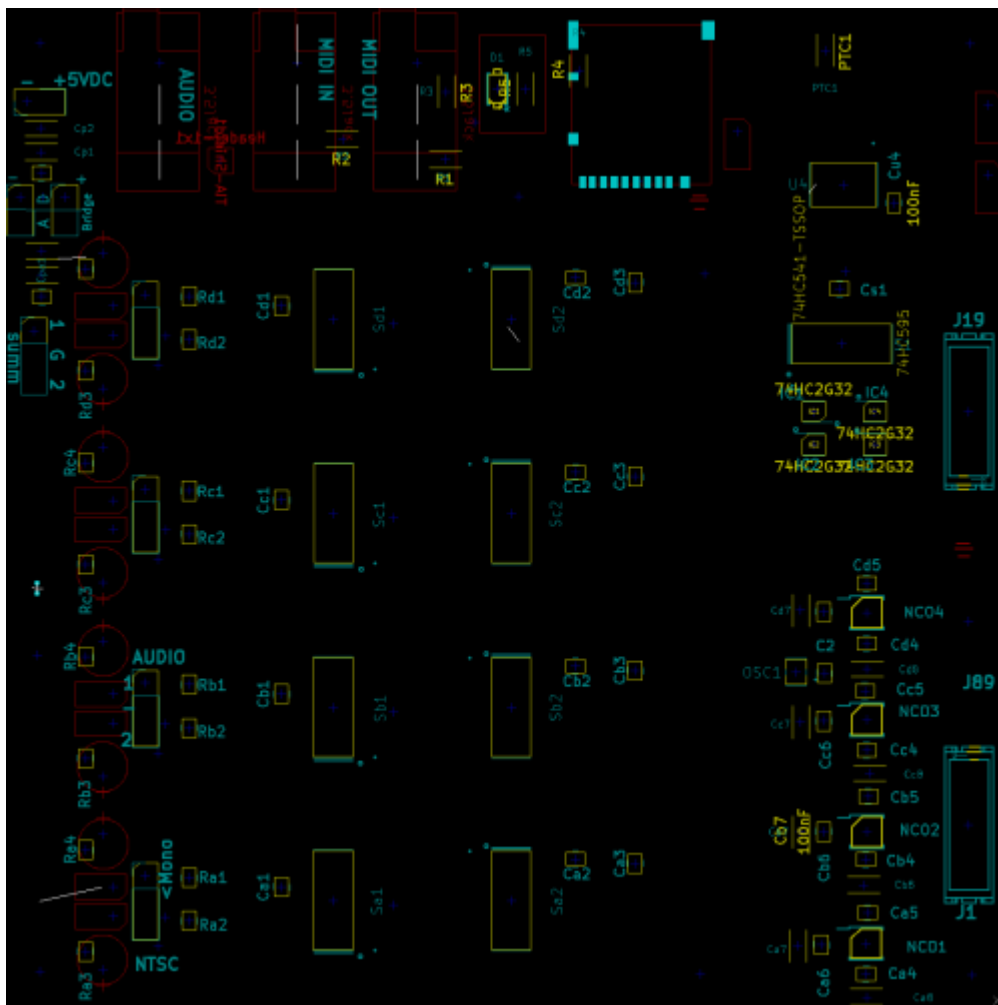

To Do

- waiting for christmas
- UI-PCBs
- Debugging First Version

Community users working on it

- **Phatline** = PCB & Schematic, UI-Programming, Documentation...
- **antichambre** = Schematic, Porting 8>32Bit, Programming...

Just let a Private message on the forum to user already involved.

Community users interested on it

- **sajtron** = Chip composer who maybe wanna buy one...

From:

<http://wiki.midibox.org/> - **MIDIbox**

Permanent link:

<http://wiki.midibox.org/doku.php?id=stellax4&rev=1617741173>

Last update: **2021/04/06 20:32**

