

IMPORTANT FOR BULK ORDER LATECOMERS !

This bulk order is officialy closed but I have bought some extra PCBs for latecomers. If you want ones, email me (jeromebo at free dot fr) the quantity you would like and your personal informations:

- Midibox username
- Paypal mail address
- Real name
- Postal address
- Country
- Level of shipping insurance you want to take.

The price of each board is 9€ (I had to buy extra shipping material) and the Paypal fee on the total is 6.5% (with 5% I lost money).

MB-LRE8x2CS PCB / 16 LEDrings/Encoders Control Surface

Welcome to the wiki page of the bulk order of the control surface board featuring combo DINx4 and improved DOUTx4 modules with 16 LEDrings and 16 encoders.

You can find the tread of this bulk order [here](#).

You can find the tread of the PCB design [here](#).

This bulk order concern the last revision of the PCB that is rev 2.4.

The price is ~~14€~~ ~~11€~~ ~~9€~~ **8,50€** each PCB (+ shipping) - This price can be slightly less expensive regarding number of boards ordered -.

It is a very practical and cheap way to make a midi controller with adding only a core or make a more important controller without having to wire LEDrings.

PCB

The PCB have components soldered on the two sides.

Top side: Encoders and LEDs.

Back side: All others components (see [BOM below](#)).

The PCB is two sides white silkscreened on green FR4 material, 1.6mm thickness, 1Oz copper, HASL, 100% E-tested & ROHS compliant.

The board is 3,368 x 13,472 inch (342,2mm x 85,5mm): just less than 2U standard.

The diameter of each LEDring is 1,299 inch (33 mm) with the use of 3mm LED.

Pictures

Protoboard (note this is not the last version but has same dimensions and LEDs/Encoders positioning):

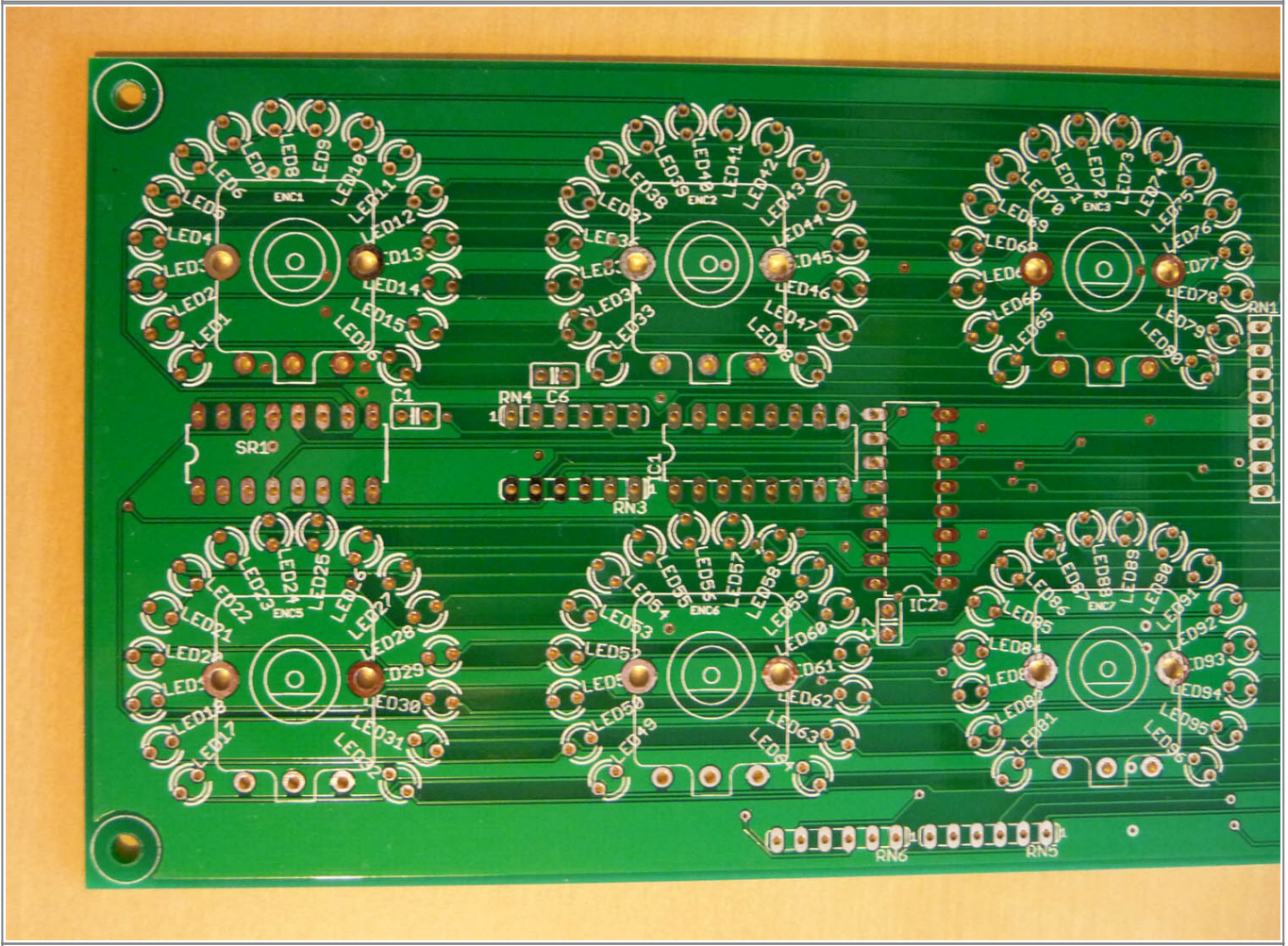
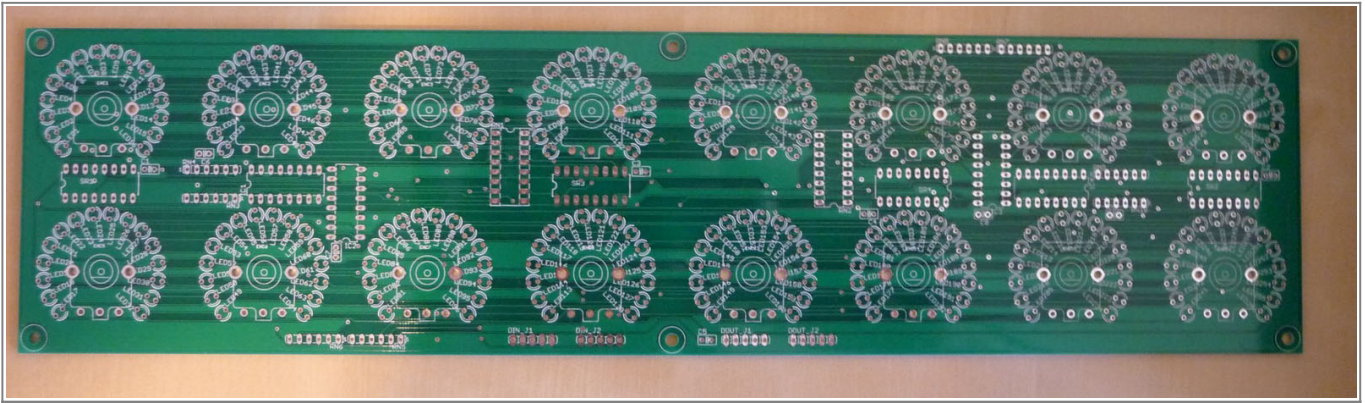

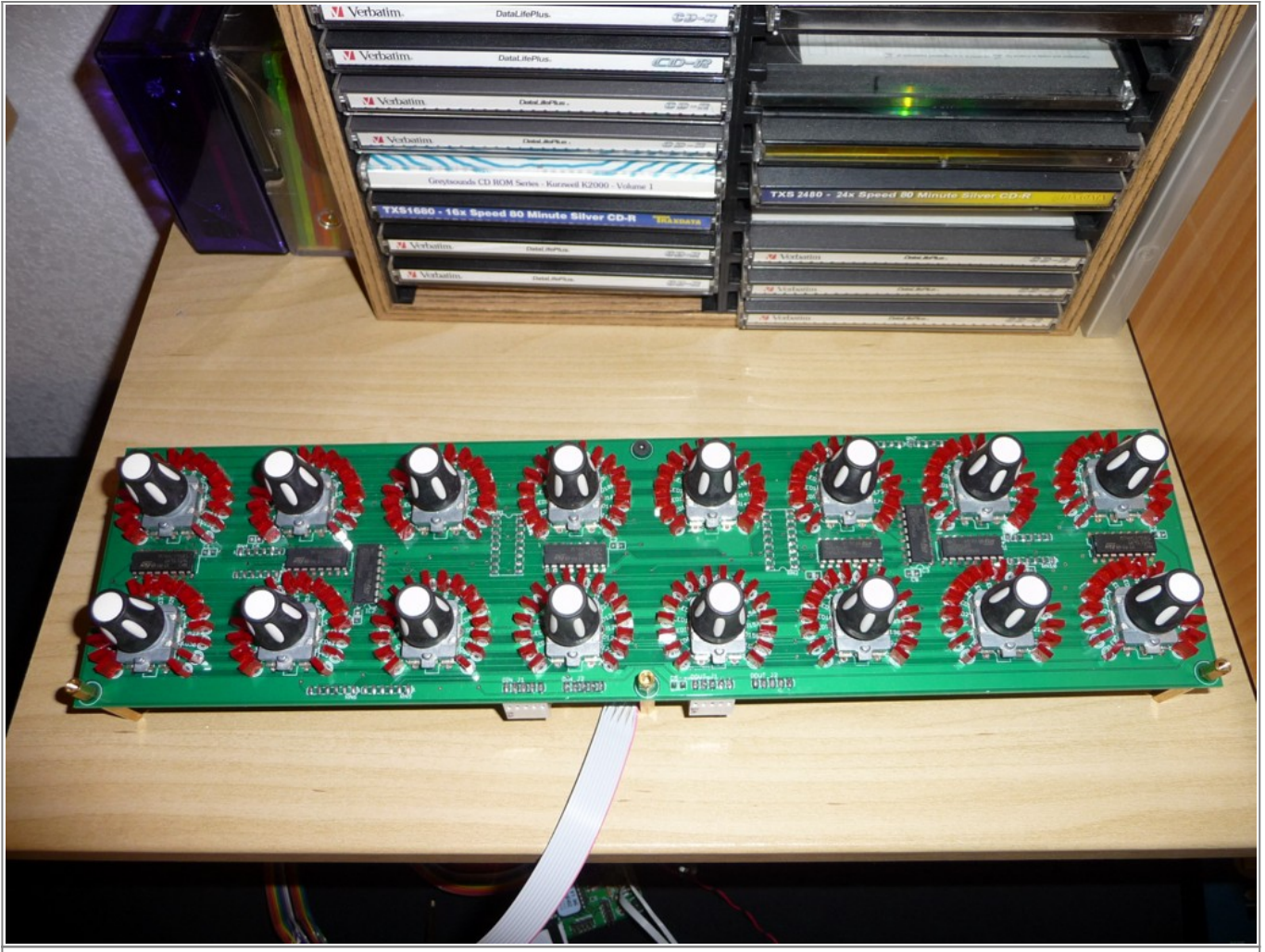

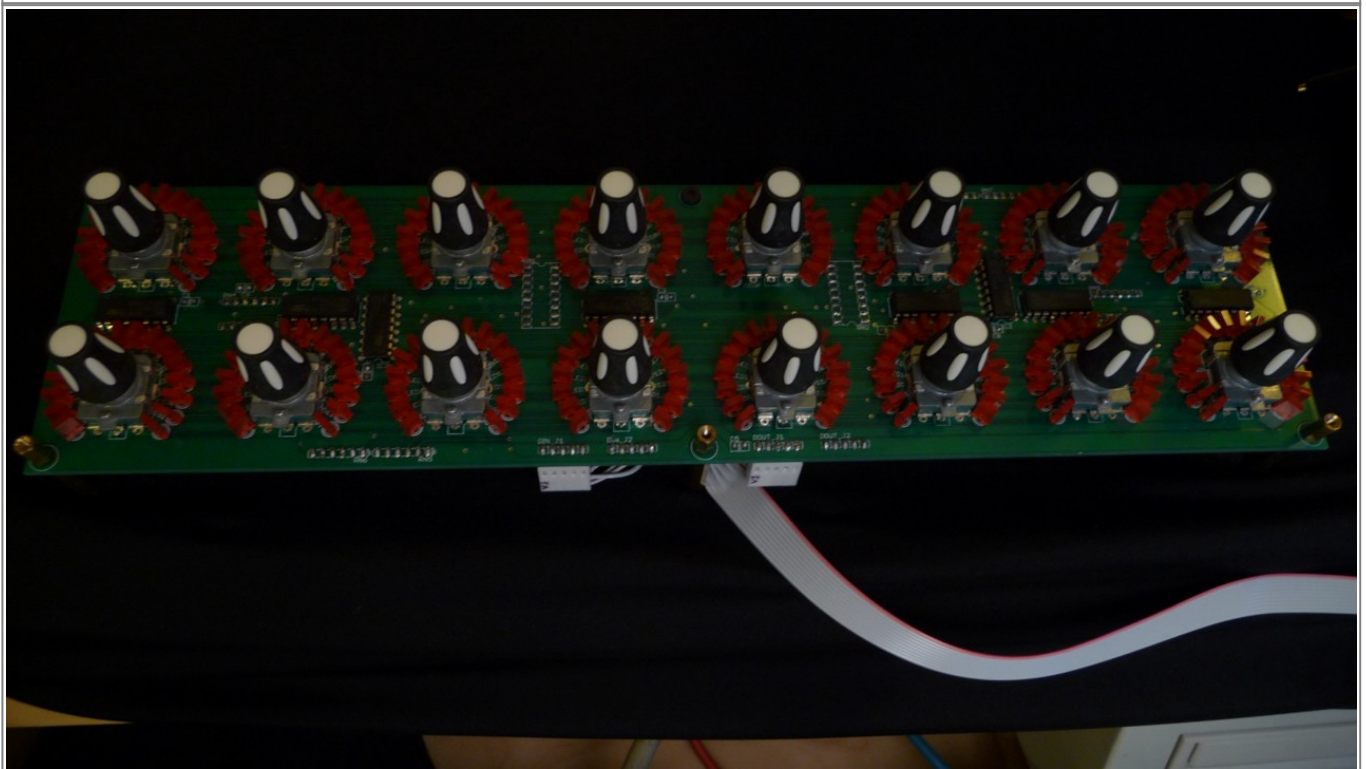
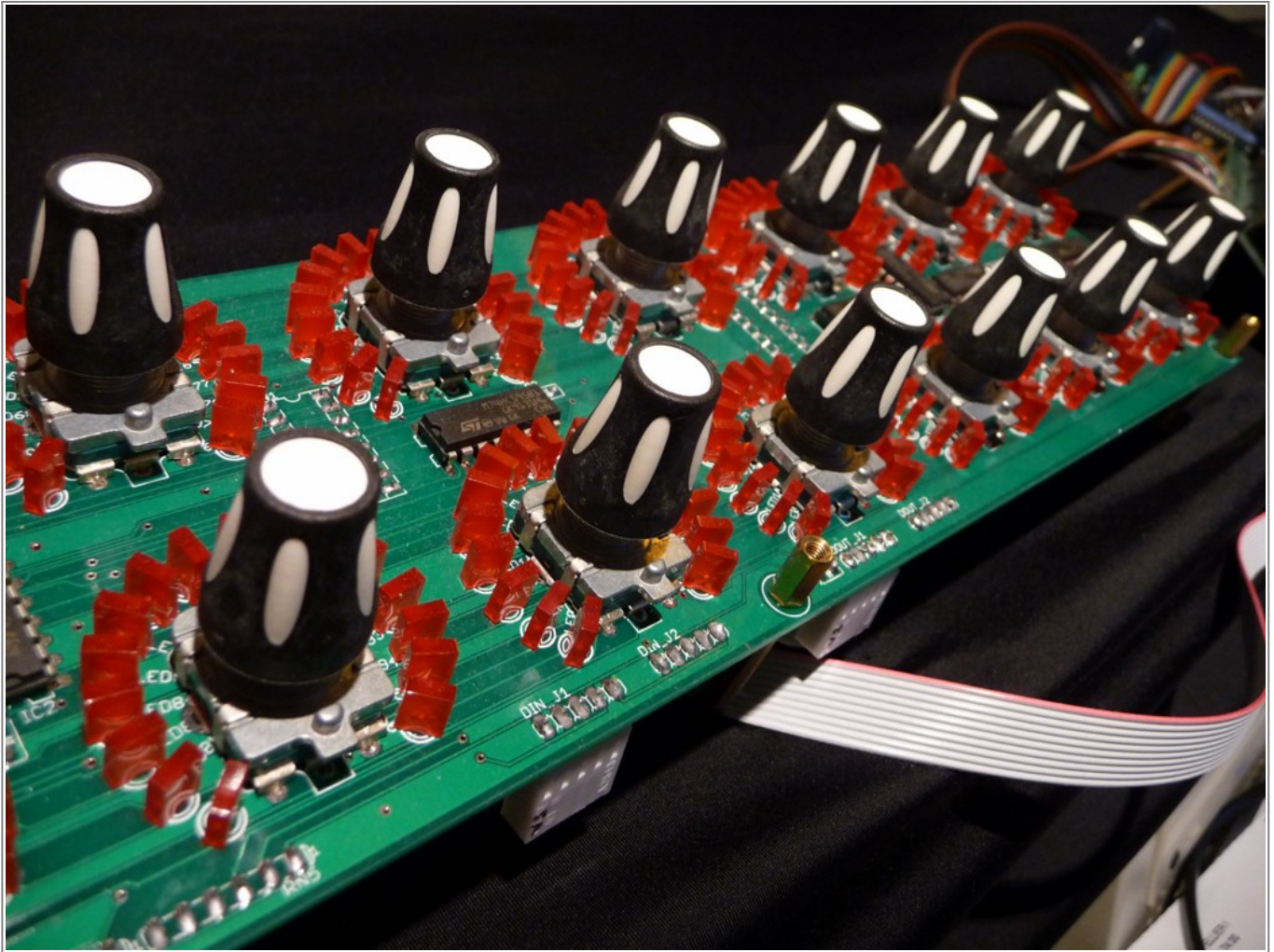

Protoboard in action:

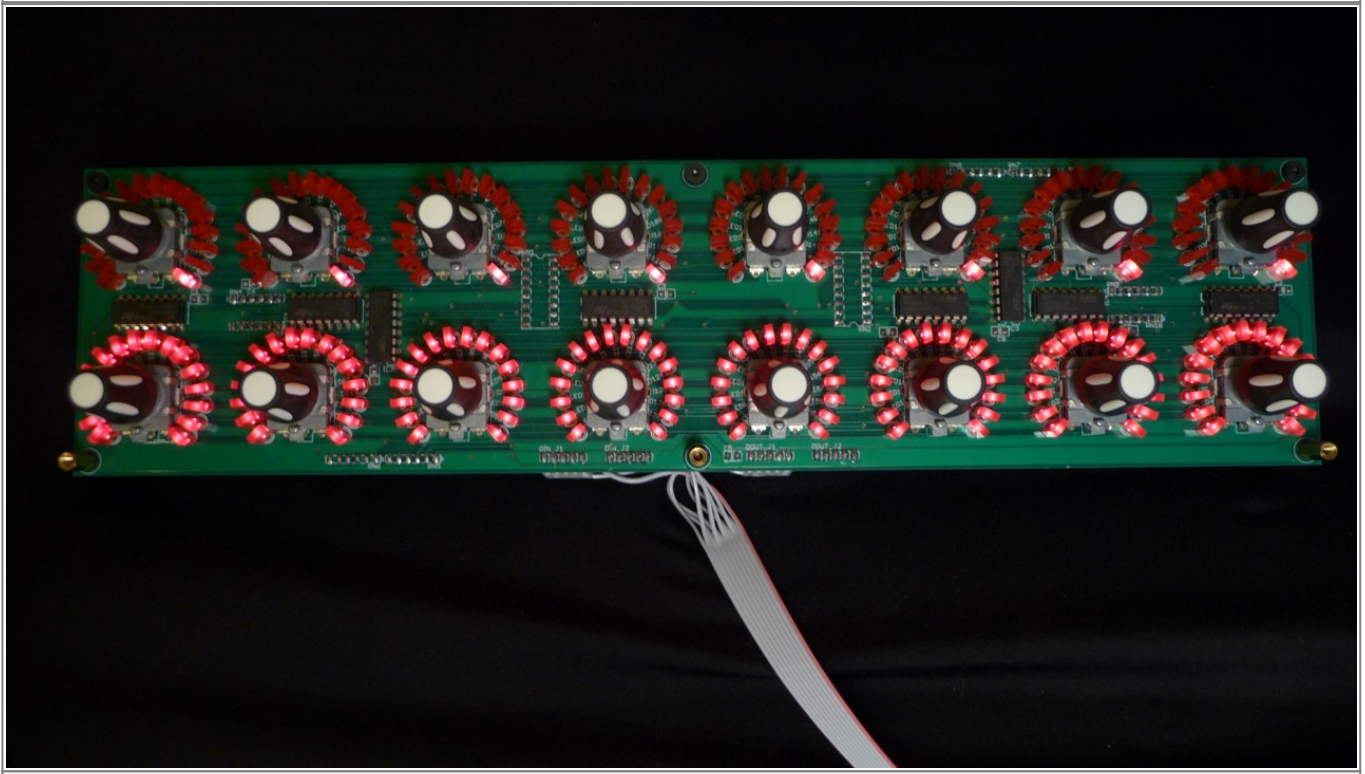
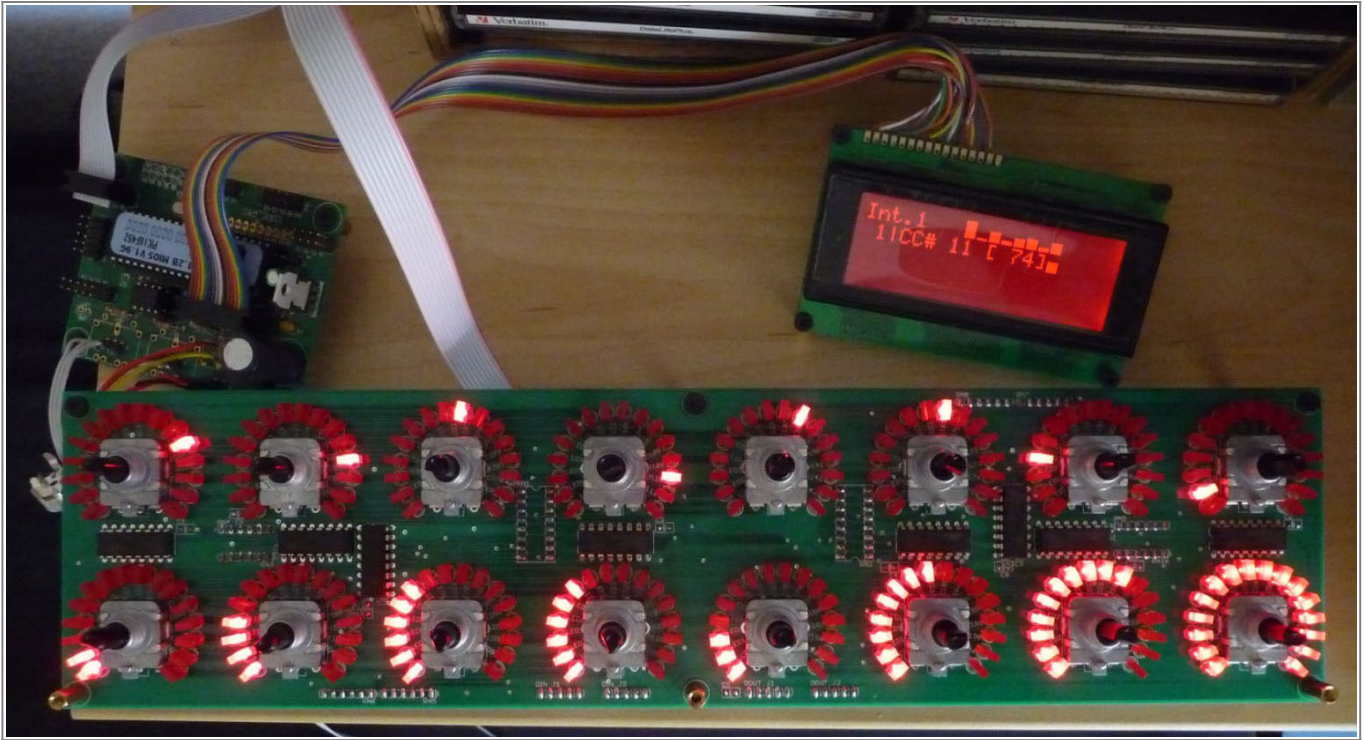

You can see the LEDring animation in this [poorly quality video](#).

Last update: 2013/01/17 14:25 mb-lre8x2cs_pcb_bulk_order http://www.midibox.org/dokuwiki/doku.php?id=mb-lre8x2cs_pcb_bulk_order

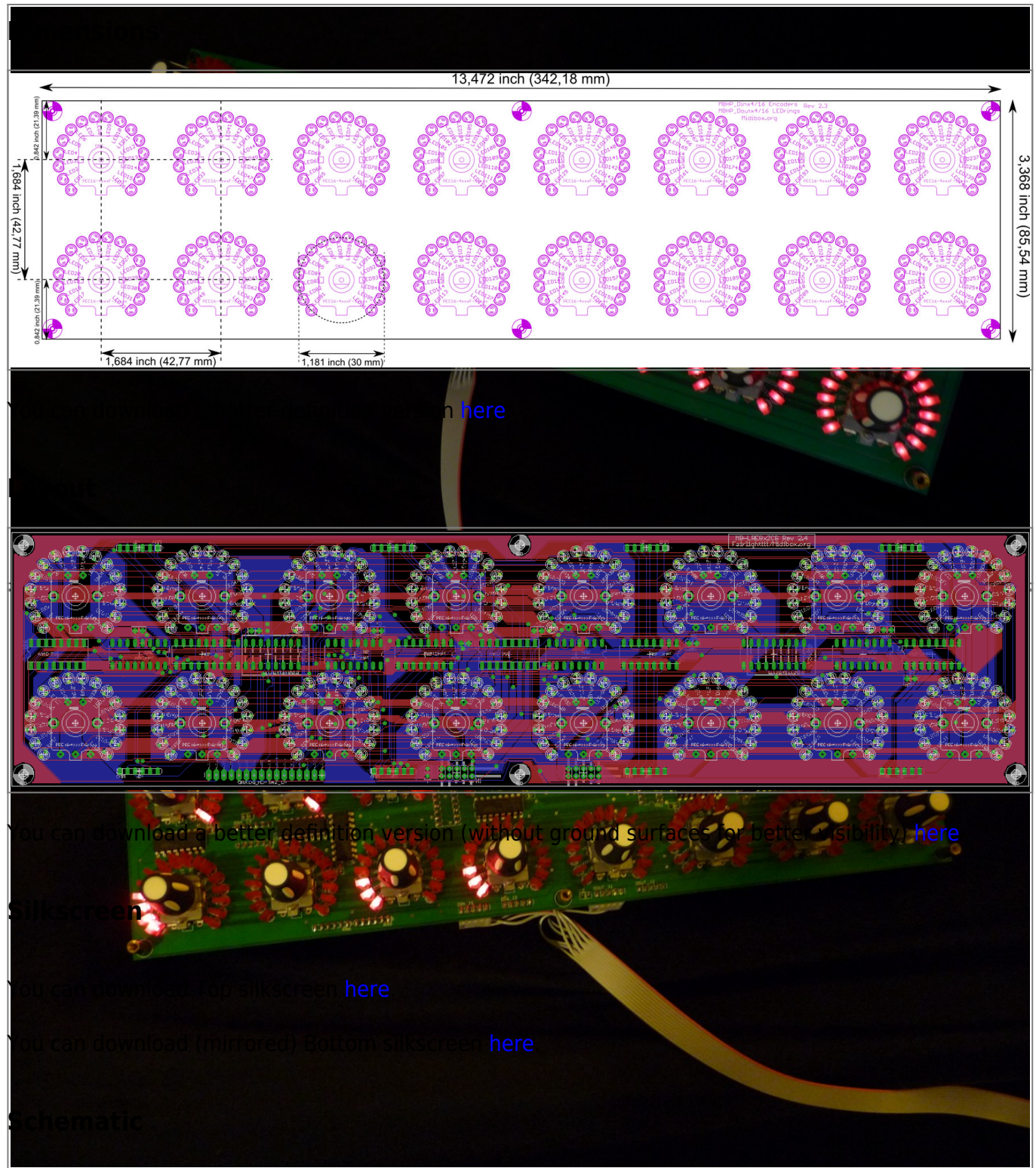

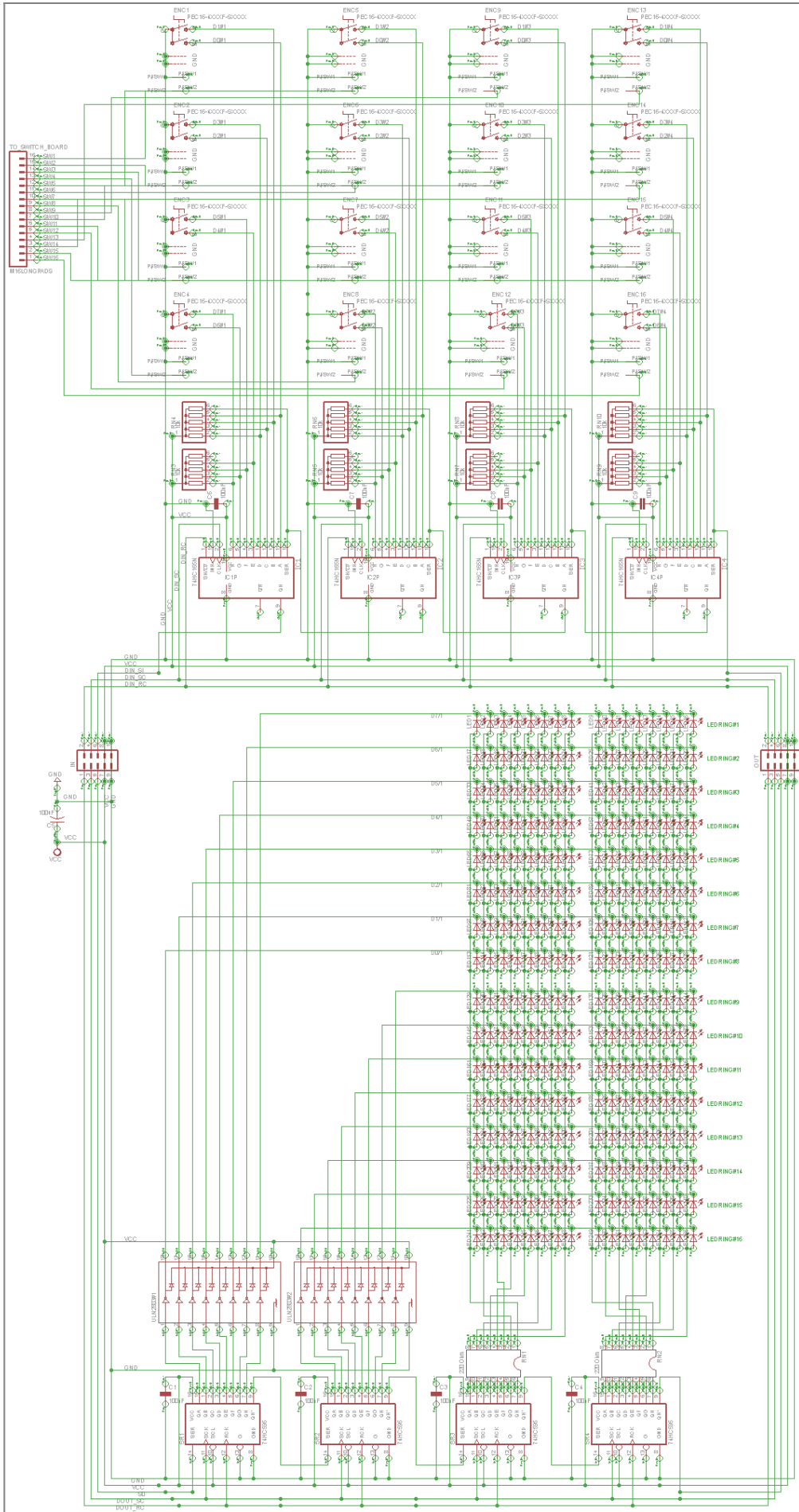

You can download a better definition version [here](#).

Coordinates

The origin (0;0) is the bottom left corner of the board.

LEDs/Encoders

You will find the coordinates of LEDs/Encoders in this [files](#) (new version with better accuracy positioning!).

3mm board holes

Coordinates of the six holes (in inch):

X	Y
0,16	0,16
6,736	0,16
13,312	0,16
0,16	3,208
6,736	3,208
13,312	3,208

BOM

Quantity	Device	Parts	REICHELT	MOUSER	Note
2	ULN2803 Transistors Darlington arrays	ULN2803#1, ULN2803#2	ULN 2803A	595-ULN2803AN	optional
8	10k 6 Pin SIL resistor network	RN3, RN4, RN5, RN6, RN7, RN8, RN9, RN10	SIL 6-5 10K	264-10K-RC	
4	74HC165	IC1, IC2, IC3, IC4	74HC 165	511-M74HC165	
4	74HC595	SR1, SR2, SR3, SR4	74HC 595	511-M74HC595	
8	Ceramic Cap 100nF=0,1uF "104"	C1, C2, C3, C4, C6, C7, C8, C9	Z5U-2,5 100n	80-C412C104K5R	
1	Polarized Electrolytic Capacitor 100 uF	C5	rad 100/16	140-REA101M1CBK0611P	
2	220 Ohm 16 Pin DIL resistor network	RN1, RN2	-	652-4116R-1LF-220	or 16x Resistor 220 Ohm
16	220 Ohm metal film resistor	8 for RN1, 8 for RN2	METALL 220	MF1/4DCT52R2200F	Instead the 2 RNs above
2	2-row DIL Header (2x5 pins)	"IN", "OUT"	SL 2X10G 2,54	649-67996-420HLF	For Reichelt, buy only 1 item and cut it in 2 parts
1	1-row SIL Header (1x16 pins)	"TO_SWITCH_BOARD"	SL 1X36G 2,54	649-68001-416HLF	optional

Quantity	Device	Parts	REICHELT	MOUSER	Note
16	PEC16-4020F-N0024	ENC1, ENC2, ... , ENC16	-	652-PEC16-4020FN0024	Undetended - without build-in switch
	or PEC16-4020F-S0024		-	652-PEC16-4020FS0024	Undetended - with build-in switch
10	Socket 16 pins	-	GS 16	571-1-390261-4	
2	Socket 18 pins	-	GS 18	571-1-390261-5	8 (NOT 9) bridges to solder if not using ULN2803s
256	LED 3mm or rectangular (2x5x7mm)	LED1, LED2, ... ,LED256	LED 3MM RT	-	Reichelt model recommended

This is a [Mouser Orderlist](#) (Thank you Lamouette). You have only to add your LEDs and Pinheaders.

LED black list

Since Tk discovered a [brightness problem](#) with some rectangular 5x2x7mm LEDs, we found it useful to create a list of LEDs wich are successfully or unsuccessfully tested. Members are welcome to edit this page to add their LED feedback.

Model	Type	Link	Good	Not good	Comment	Author
Kingbright WP103HD	5x2x7mm rectangular	Mouser		X		Tk
LED 3MM RT	3mm round	Reichelt	X			Tk
"10001"	5x2x7mm rectangular	auspiciousmall.com		X		Fairlightiii
Kingbright L-934ID	3mm round	Segor Electronics	X			rvlt

Components

LEDs & LEDring

Each LEDring is composed of 16 LEDs.

You can use 3mm LEDs or 5x2x7mm rectangular LEDs (because the different angles of the LEDs in the LEDring) or all other LED with 0.1 inch (2,54 mm) leads spacing.

There's not enough space for 5mm LEDs.



The LED polarity: the cathode (short leg) has to show to the center of the LED ring:

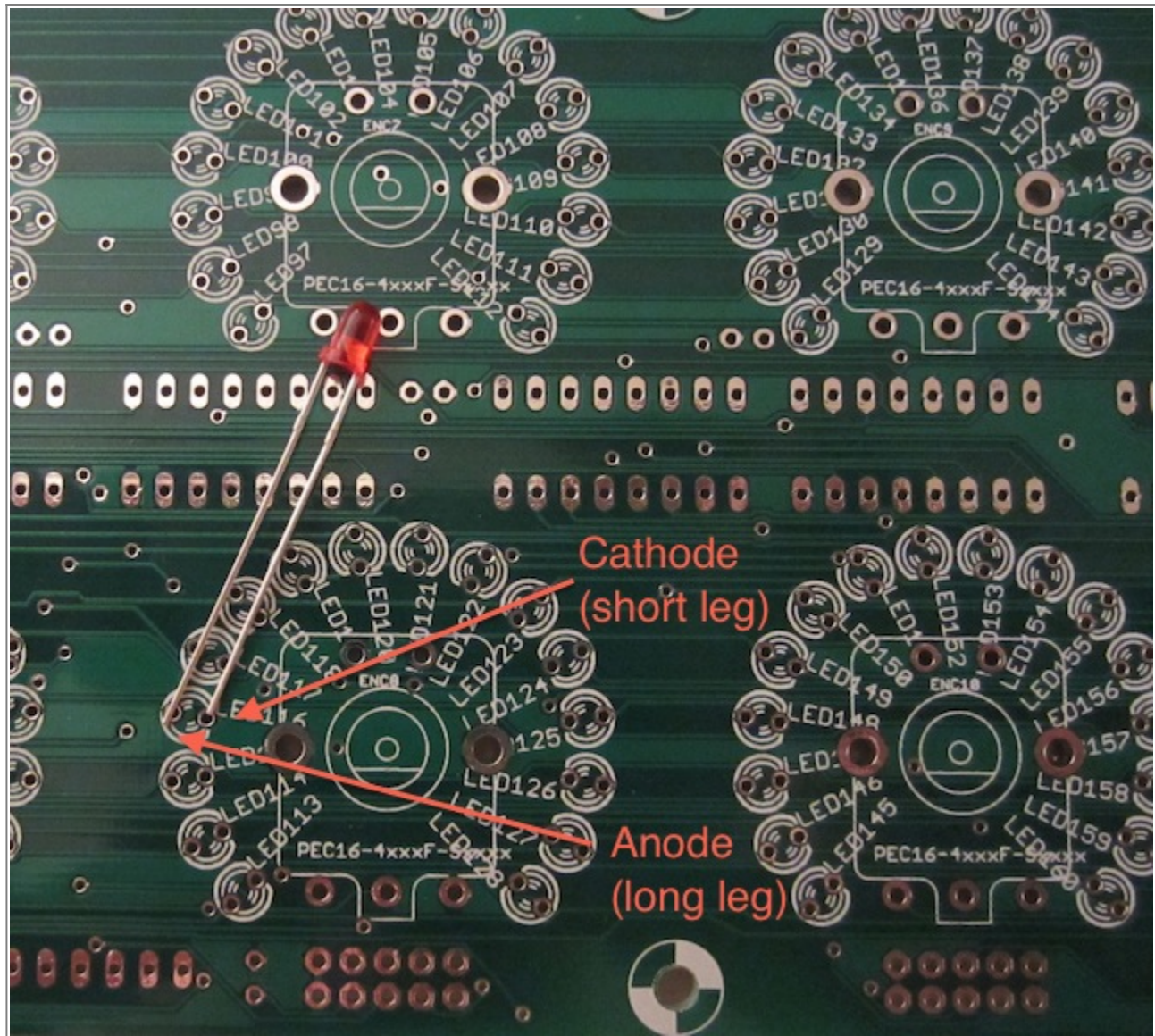

Encoder

You can use 16mm “standard” encoders (ALPS STEC16, Bourns PEC16-4xxxF-Nxxxx series, encoders sell by [voti](#), ...).

You can use instead PEC16-4xxxF-Sxxxx series (with built-in switch). Probably others built-in switch encoders comply the PCB footprint but you have to compare before [datasheets](#).

16 pins SIL header

If you use switched encoders, one of the two pins of the built-in switch is grounded while the other pin is connected to a pin of this SIL connector.

The silkscreen include the name of each switch.

2x5 pins DIL headers

They are 1:1 with J8/J9 of Core8/Core32/LPC17 so you can use practical [IDC female Connector](#) or still

more easier [pre-built 2x5 Pin IDC Ribbon Cable](#).

Be careful to the [connection to the MBHP_CORE_LPC17 module](#) because it could be confusing, since the SO pin of J8/9 has to be connected to the SI pin of the LRE2x8 board, and SI to the SO pin (for MBHP_DOUT/DIN we usually have the same names for these signals, this detail has been overlooked).

ULN2803

This component provide more current to the matrix LED than the 74HC595 shift registers can and improve the brightness of the LEDs.

You can use or not Transistors Darlington arrays.

In the second case (and only in this case), you need to bridge 16 of the 18 free pins 2 by 2 (in red on the picture):



Be careful to not bridge the 2 last pins (those opposite to the "head" of the chip).



An idea is to use e.g. DIP16 Switch. ([NT 08](#) at Reichelt).

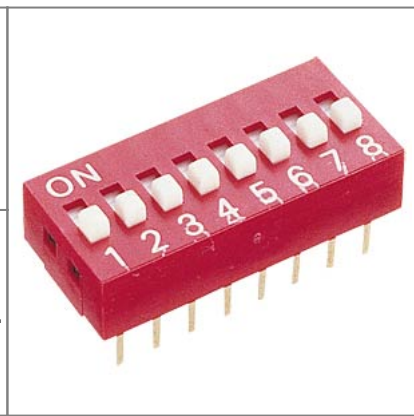

220 Ohm 16 Pin DIL resistor network

As in the SmashTV's PCB, you can replace a DIL resistor network by 8 resistors.

In this case I recommend to use 1% metal film resistors because with the tolerance of standard carbon resistors you could see maybe different brightness of each LED of the LEDring.

10kOhm 6 Pin SIL resistor network

Be careful when sourcing SIL resistor networks because a 6 Pin SIL resistor network can be 5 commoned resistors (what you need here) or 3 independant resistors.

Polarized Electrolytic Capacitor 100 uF

It is the only polarized cap of the board. The silkscreen indicate the "+" and "-" signs on the board.

Diagram interconnection

One board connection



Only one 2x5 Pin IDC Ribbon Cable is necessary to connect the board.

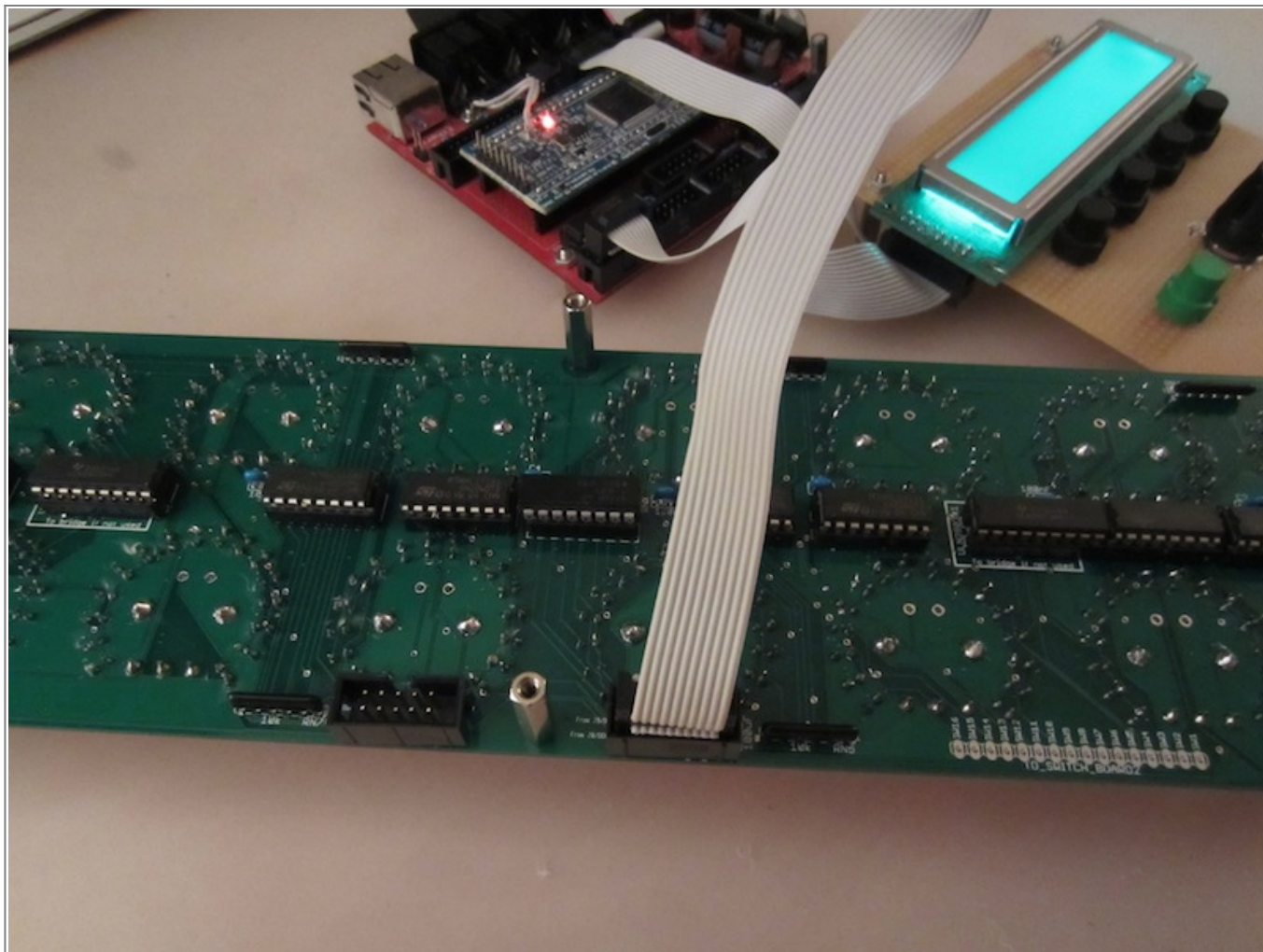

Global interconnection



You can download a better definition version [here](#).

You can chain 4 of this board or connect yours extra DIN/DOUT modules e.g. on the DIL connector named "OUT".

You can connect also this board at the end of the chain and connect this board with the "IN" connector after yours others modules.

With the use of the upcoming [MIDIbox NG](#) (planned for Winter 2012/13) you will be able to have 2 chains of 4 boards each ($2 \times 4 \times 16 = 128$ encoders and $2 \times 4 \times 16 = 128$ LEDrings).

BULK ORDER

- The shipping charges from me to each member has to be add at the total price PCB(s)+ Mouser components.
- Payment is accepted only by PayPal (5% fees to add on the total including shipping).
- The eventually custom duty is the responsibility of each member.

Shipping Cost

I won't refund in case of the shipment get lost.

COUNTRY	Insurance level	Number of PCB							
		1	2	3	4	5	6	7	8
France	Without insurance	1,80 €	3,10 €	3,10 €	3,10 €	4,00 €	4,00 €	4,00 €	4,00 €
France	With insurance 16€	6,18 €	7,03 €						
France	With insurance 153€		7,63 €	7,63 €	7,63 €	8,58 €	8,58 €	8,58 €	8,58 €
European Union (UK, Germany, Greece, ...) & Swiss	Without insurance	4,10 €	6,10 €	6,10 €	6,10 €	8,75 €	8,75 €	8,75 €	8,75 €
European Union (UK, Germany, Greece, ...) & Swiss	With insurance 45€	9,70 €	11,70 €	11,70 €	11,70 €	14,35 €	14,35 €	14,35 €	14,35 €
European Union (UK, Germany, Greece, ...) & Swiss	With insurance 150€						15,35 €	15,35 €	15,35 €
Norway	Without insurance	5,60 €	7,35 €	7,35 €	7,35 €	10,80 €	10,80 €	10,80 €	10,80 €
Norway	With insurance 45€	11,20 €	12,95 €	12,95 €	12,95 €	16,40 €	16,40 €	16,40 €	16,40 €
Norway	With insurance 150€						17,40 €	17,40 €	17,40 €
US, Canada, Brazil, Australia, ...	Without insurance	5,60 €	7,35 €	7,35 €	7,35 €	10,80 €	10,80 €	10,80 €	10,80 €
US, Canada, Brazil, Australia, ...	With insurance 45€	11,20 €	12,95 €	12,95 €	12,95 €	16,40 €	16,40 €	16,40 €	16,40 €
US, Canada, Brazil, Australia, ...	With insurance 150€						17,40 €	17,40 €	17,40 €

If you take "with insurance" you will be compensated of the amount of the insurance in case of lost of the parcel and your shipment is tracked (until your door in this country: Germany, Belgium, Denmark, Finland, UK, Hong-Kong, Ireland, Japan, Luxembourg, The Netherlands, Slovakia, Sweden, Swiss and

until the French frontier for the others country). In any case I receive a proof of delivery.

For (french language) tracking page, it's [here](#). Fill the textbox "Numéro de suivi" with your number.

If you take "without insurance" there's no tracking of the parcel.

If your country is not in this table, or if you want more PCBs, PM or email me.

Time Frame

- Bulk order start: ~~October 29th 2012.~~
- End of the list: ~~November 18th 2012.~~
- I PM (or email) member with the total amount to pay: ~~November 18th – 20th 2012.~~
- Payments will be accepted until ~~November 25th 2012.~~
- I order the PCBs: ~~November 26th 2012.~~
- PCBs arrive near the ~~December 5th 2012.~~
- I ship the PCBs to each member: ~~December 5th – 8th 2012.~~
- Time frame may be subject to change due to unforeseeable events.

Because there are [not enough stocked DIL resistor networks in Mouser shop](#), this is the new time-frame:

- Bulk order start: October 29th 2012.
- End of the list: November 23th 2012.
- I PM (or email) member with the total amount to pay: November 24th - 26th 2012.
- Payments will be accepted until November 30th.
- I order the PCBs and the Mouser order: December 1st 2012.
- PCBs and Mouser order arrive near the December 12th 2012.
- I ship the PCBs and Mouser components to each member: December 13th - 15th 2012.

LIST

By putting your name on the list you agree to the terms and conditions described here: www.midibox.org/dokuwiki/nils_bulk_terms.

Use your full and **correct FORUM (not the wiki) name**, so I can reach you via PM or email.

Click on the "Edit this page" button (top left corner) and add your MIDibox username and the number of components you would like.

UPDATE THE QUANTITIES TO THE END OF THE LIST.

Do not edit anything else on this page (except to correct my English or spelling mistakes!).

Username	PCB	10k SIL RN	220 Ohm DIL RN
	8,50€ (November 20th)	0,08€ (November 20th)	0,26€ (November 16th)
Fairlightiii	20	24	12
jojjelito	8	64	16
NorthernLightX	1		
rvlt	4	32	8

Username	PCB	10k SIL RN	220 Ohm DIL RN
Hawkeye	8	64	16
Lamouette	4	32	8
Antix	2	40	
shimoda	3	24	6
monokinetic	2		
norbim1	2	16	4
benuron	2	16	4
defenestration	4	32	8
kelargo	4	32	8
TK	4	32	8
johnniebee	4	32	8
borbathegeek	2	16	4
Beat	4	32	8
gslug	4	32	8
grizz	4	32	8
latigid on	2	16	4
zephyrin	2		
gtxdude	2		
Prosperity	2	16	4
dnode	6	48	12
ilmenator	4		
toadstool	2	16	4
mburch	2	16	4
lylehaze	2	16	4
V`cent	3	24	6
TheProf	2		
anderspe	2	16	4
taximan	8	64	16
ermangaver	2	16	4
Elektruck	8	70	20
MaG2k	4	32	10
dsdonnes	2	16	4
shaduz	2	16	4
103 Bert	1	8	2
dinama	4	32	8
ctrl+z	1	8	2
gomiboy99	4		
raoulblues	4	32	10
boops	4	32	10
rosch	2		4
Dreadknot	1	10	8
Milky	4	32	10
HerrPaule	2	10	6
sam	4	36	10
fantomxr	2	20	6

Username	PCB	10k SIL RN	220 Ohm DIL RN
technobreath	1	8	2
Mirmidi	4	32	8
Total :	181	1194	320

Bulk order update

As many people want some onboard components and as resistor networks (SIL and DIL) are not easy to find at good price for few quantity, I add a bulk order only for SIL and DIL resistor networks to this bulk order. Others components (except encoders) are easily "sourcable" on Internet.

I have modified the list with 2 new columns.

Importants informations:

- I will make the Mouser order the same moment I will order the PCBs.
- Only member which order PCB(s) can participate (...sorry!).
- The weight (...and the price) of the shipping of the parcel to each member shouldn't be different (except maybe for 4 boards where the weight was very slightly less than the limit of 0.5kg: But my kitchen food balance say me it should be ok) - Well understood each member doesn't buy to much components! -
- The price (in euros) of the [652-4116R-1LF-220](#) and the [264-10K-RC](#) will be the one Mouser propose regarding the quantity ordered for each item.

Jérôme aka **Fairlightiii**.

—I tried to be clear but if I made a mistake or if I forgot something, don't hesitate to say it in the [forum](#).—

PS: Excuse me for my poor English!

From:
<http://www.midibox.org/dokuwiki/> - **MIDIbox**

Permanent link:
http://www.midibox.org/dokuwiki/doku.php?id=mb-lre8x2cs_pcb_bulk_order

Last update: **2013/01/17 14:25**

