

The MBHP_4066 Board

For MIDifying old analog Sound gear You'll need bilateral switches in some cases.

In my case I needed more than 100 of them!

For that reason (and with the engaged support of **nILS** and **PCB Mike**) the **MBHP_4066** board was created.

One MBHP_4066 board provides 16 bilateral switches.

For more Information have a look at the pdf file below.

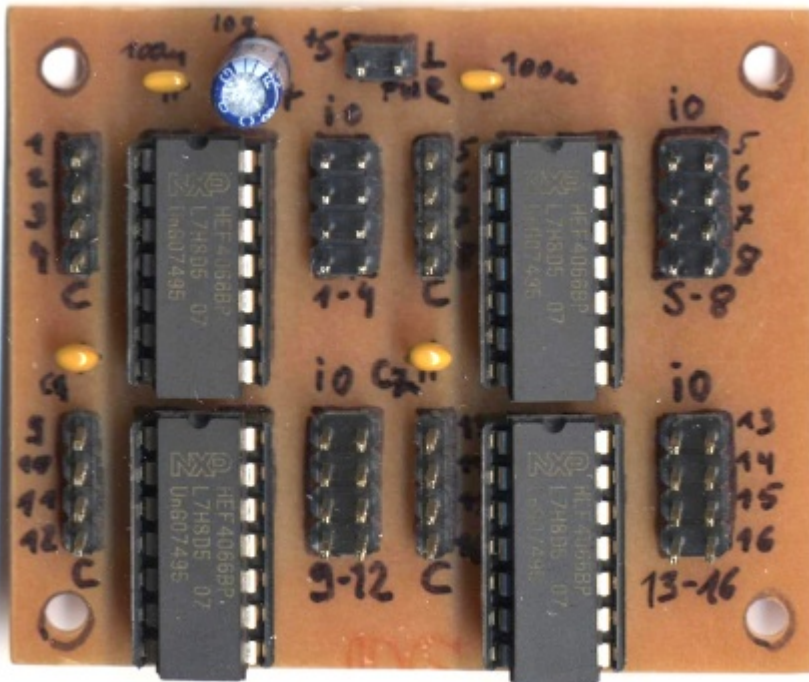

The MBHP_4066 Board (assembled)

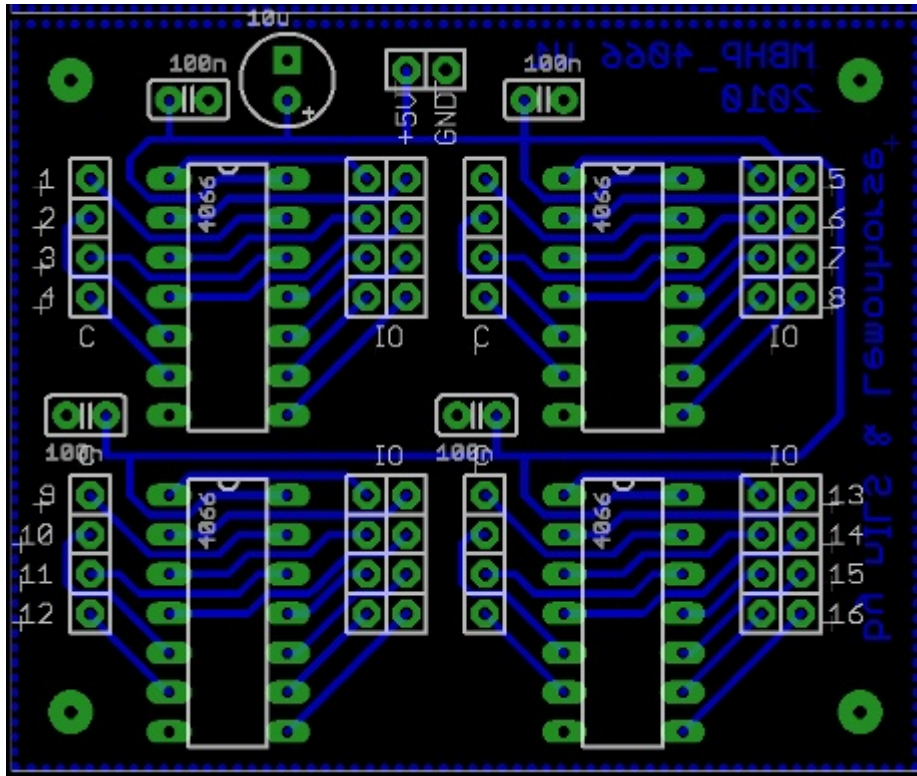

The MBHP_4066 Board (PCB, Eagle)

Overview and Details:

- **MBHP_4066** with remarks and a Partlist ==> <http://www.subfrequenz.net/midibox/vss200/mbhp4066v1/MBHP4066V1.pdf>
- PCB Mike will provide the MBHP_4066 board in his Onlineshop
- 4066 Datasheet (found no better source yet) ==> <http://pdf1.alldatasheet.com/datasheet-pdf/view/8175/NSC/4066.html>

- Lemonhorse (28.05.2010)

From: <http://www.midibox.org/dokuwiki/> - **MIDIbox**

Permanent link: <http://www.midibox.org/dokuwiki/doku.php?id=mbhp4066>

Last update: **2010/05/28 22:07**

