

Construction drawings for Midibox Genesis case

Fits front panel made by Sauraen.
Drawings made on Hoth by Technobreath ©2017

FOR TEST PURPOSE ONLY. FINAL VERSION AVAILABLE AFTER BETA BUILDING TESTPIECE!
O-: BUILD NOW – CAD LATER :-O

Build case from 9mm MDF or high density plywood (birch etc.)

uCApps.de



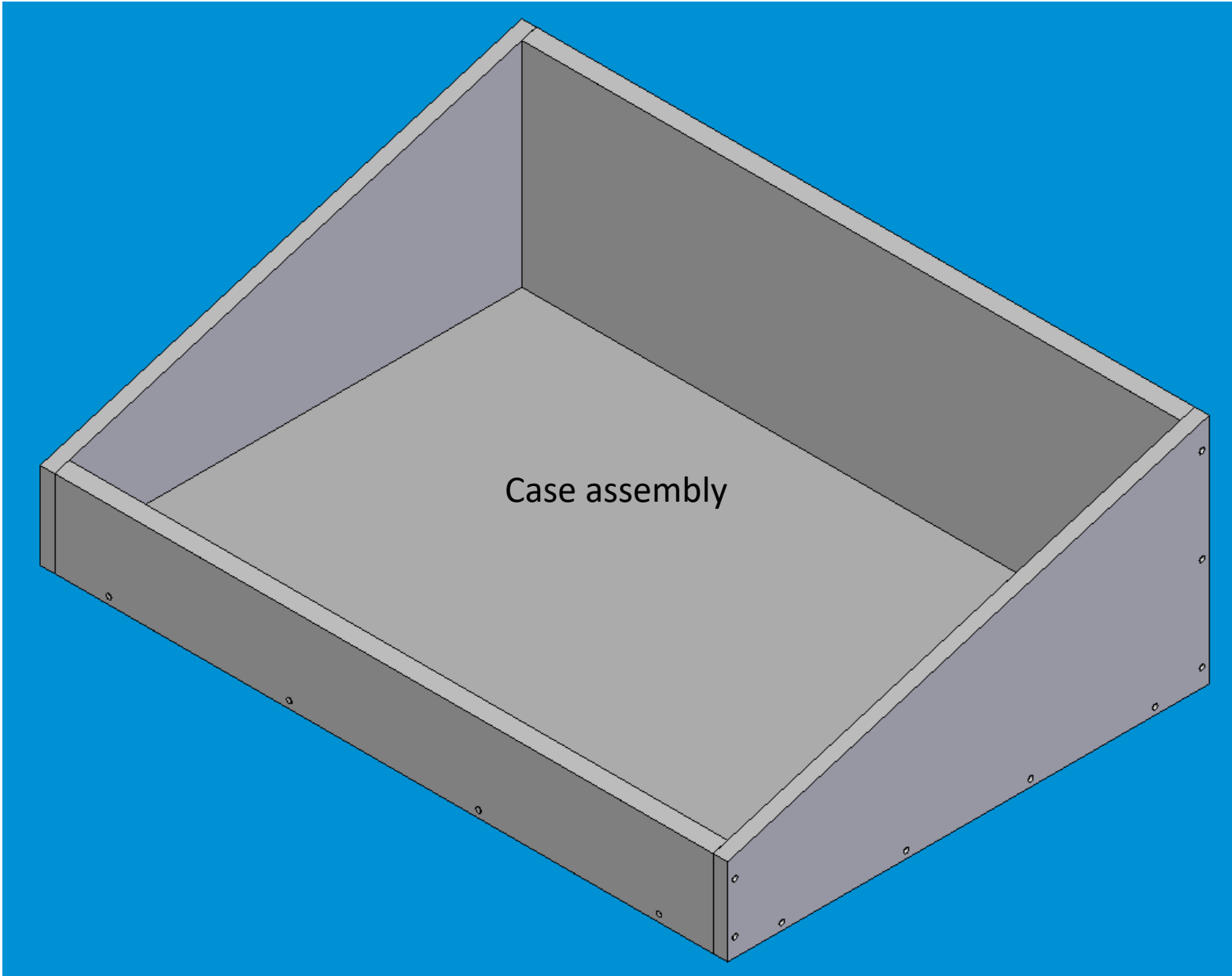

Case assembly

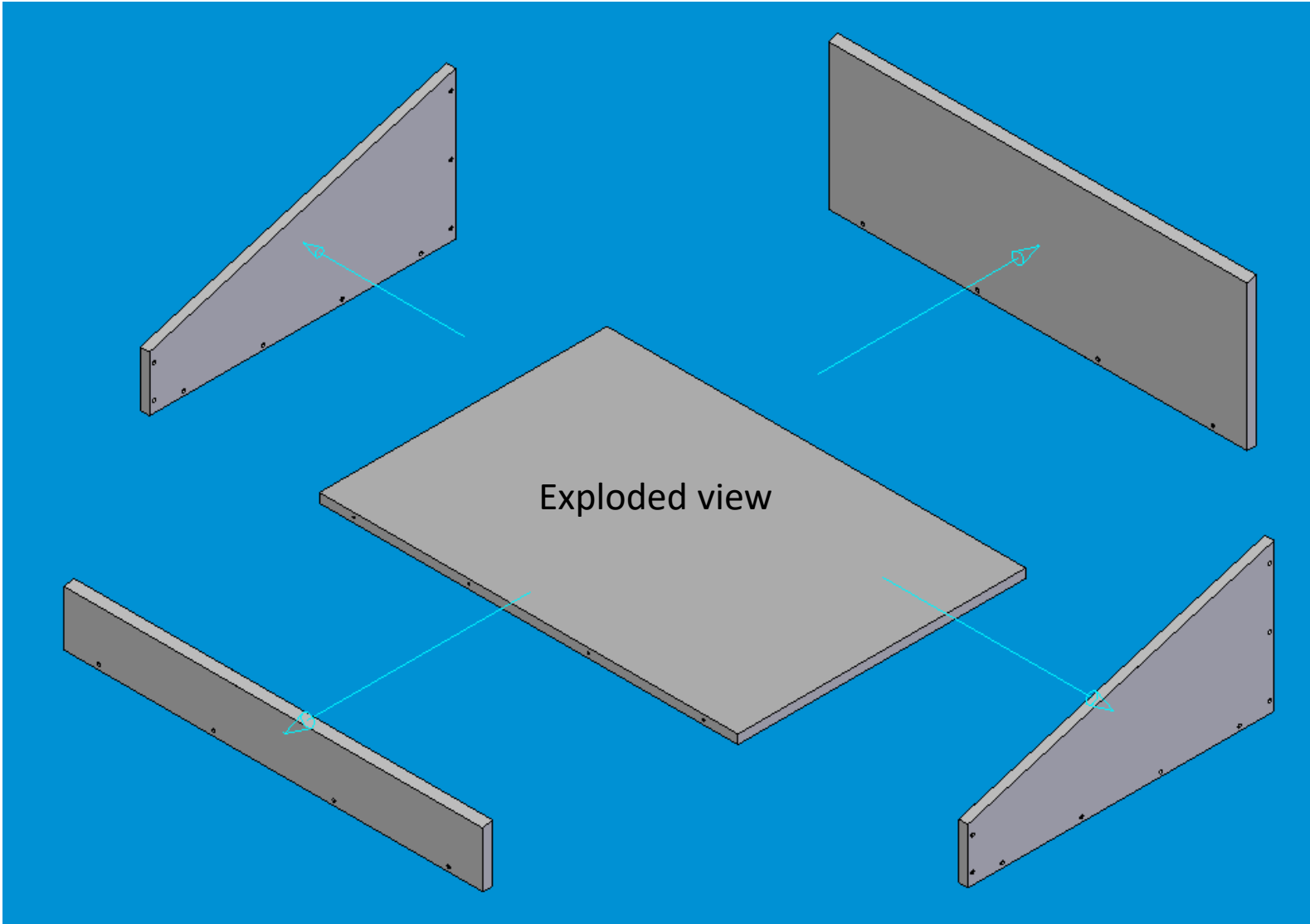

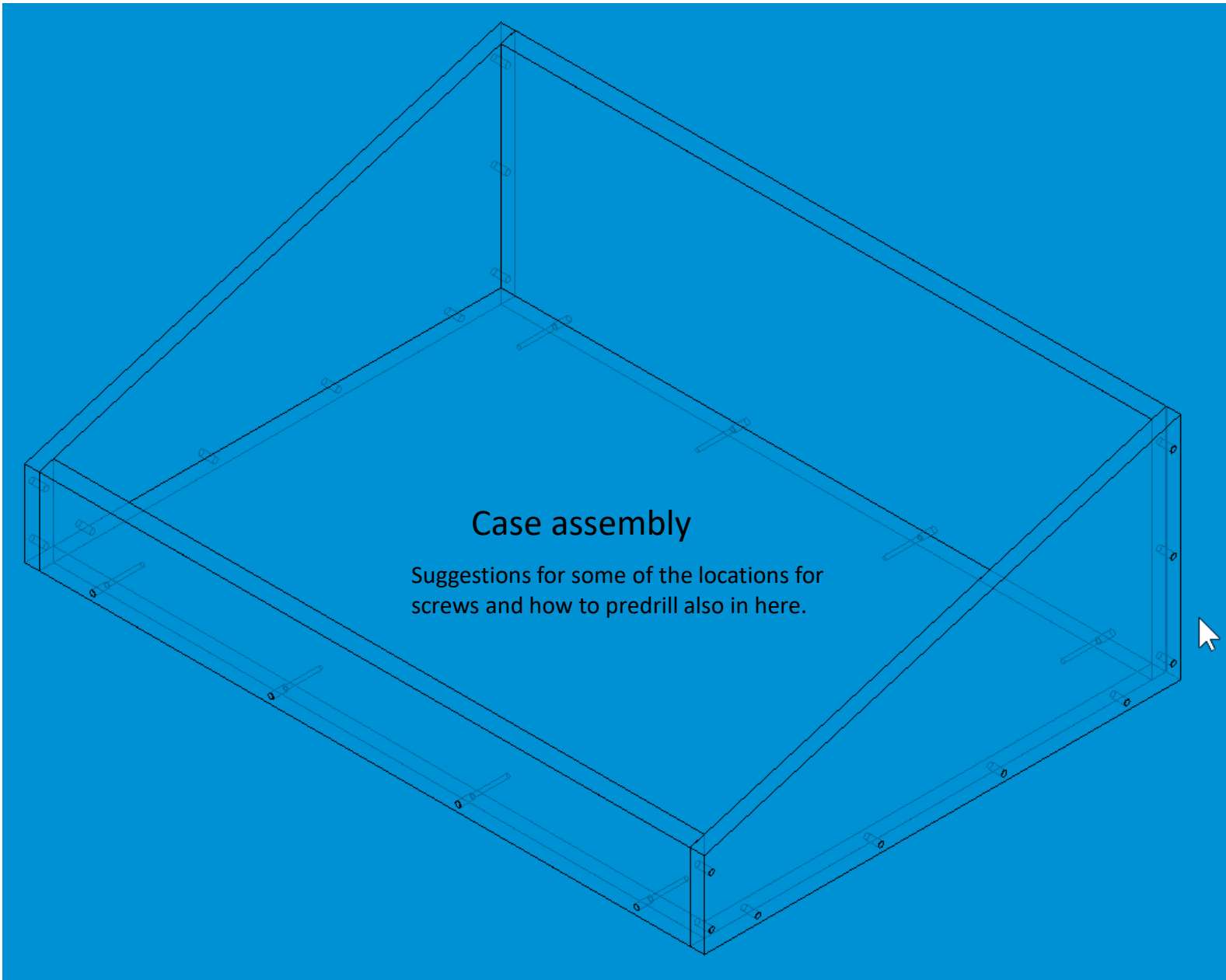

Case assembly

Suggestions for some of the locations for screws and how to predrill also in here.

Side panel. x2

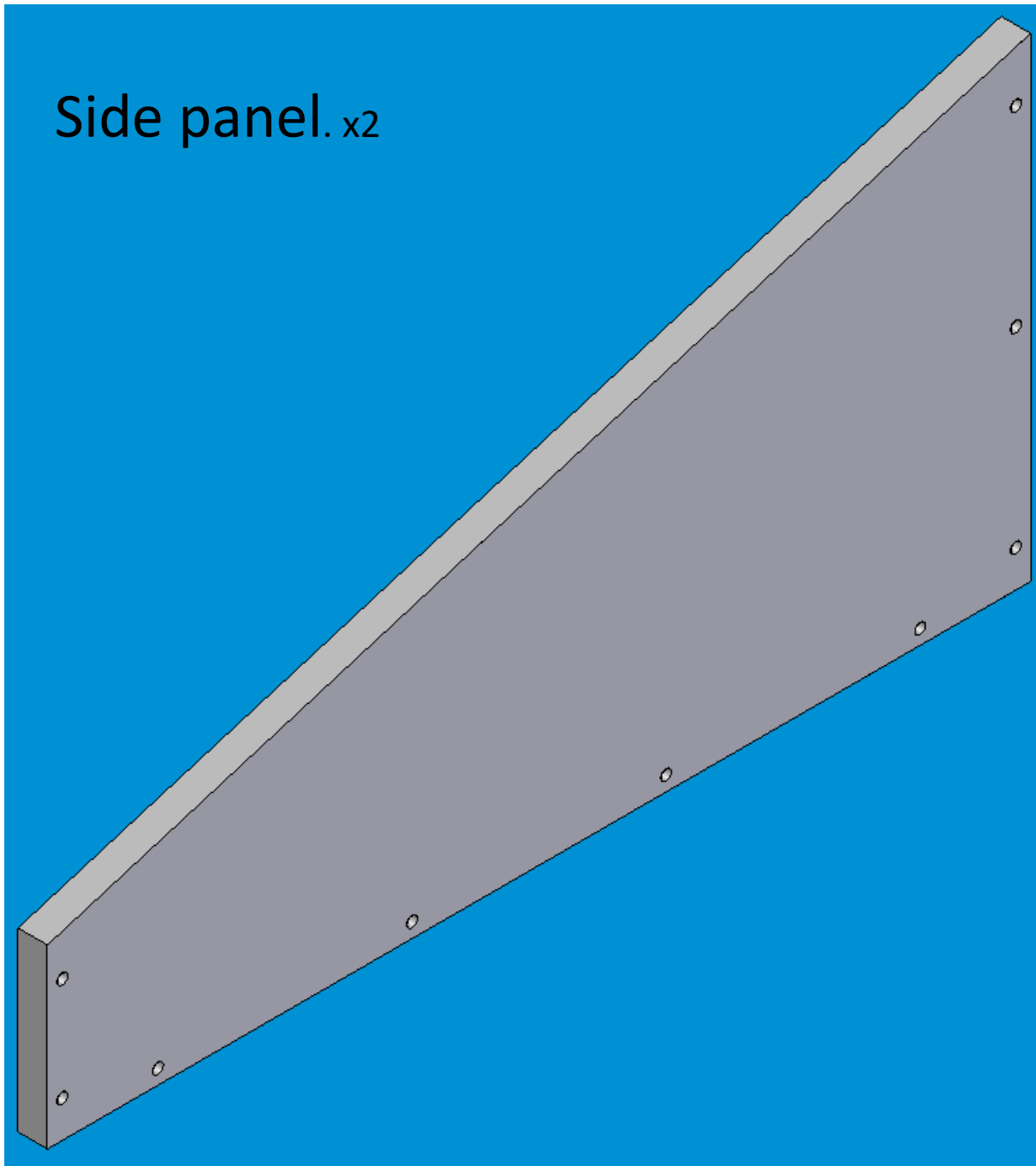

Side panel

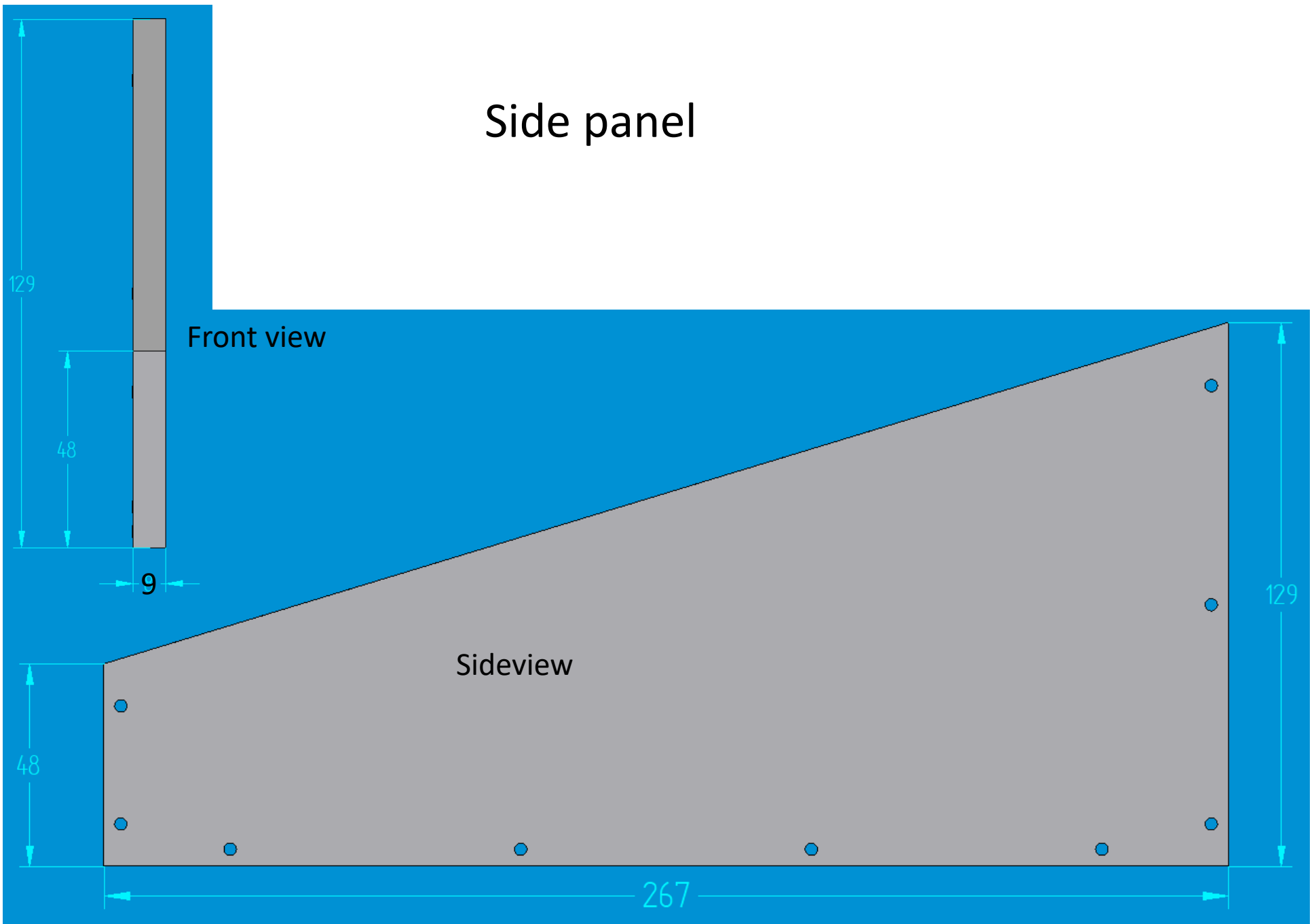

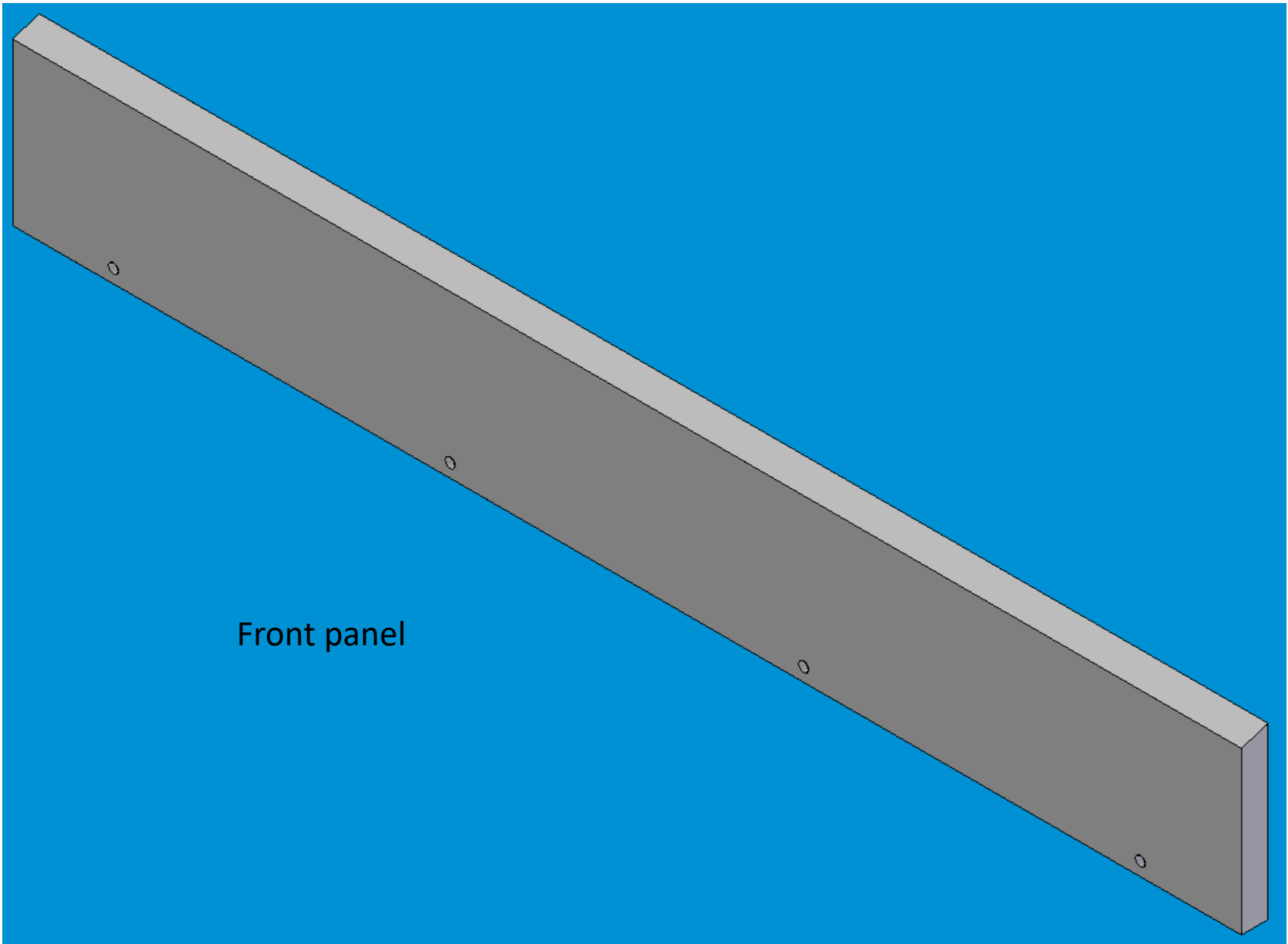

Front panel

Front panel

Sideview

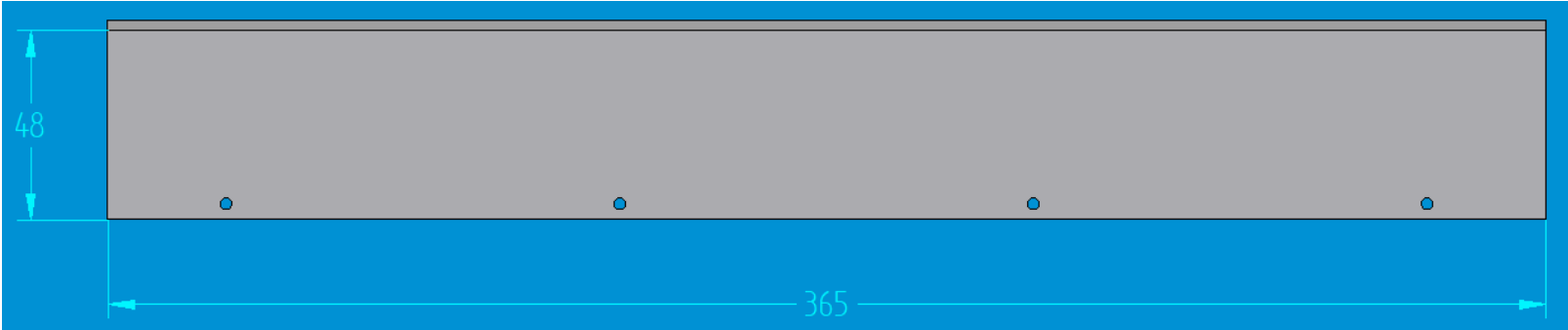
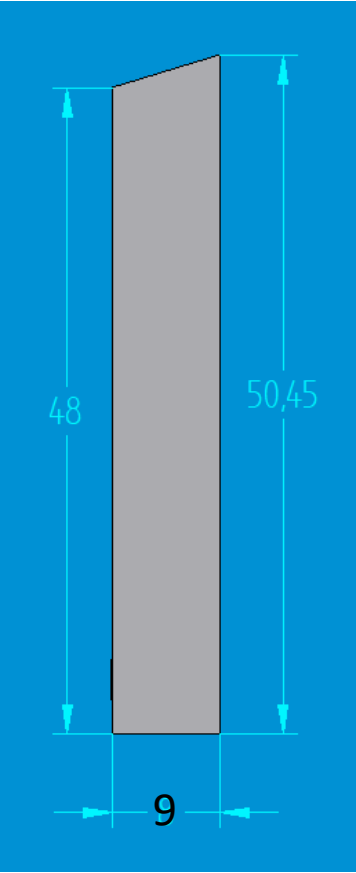

Frontview



Rear panel

View from inside the case

Rear panel

Sideview

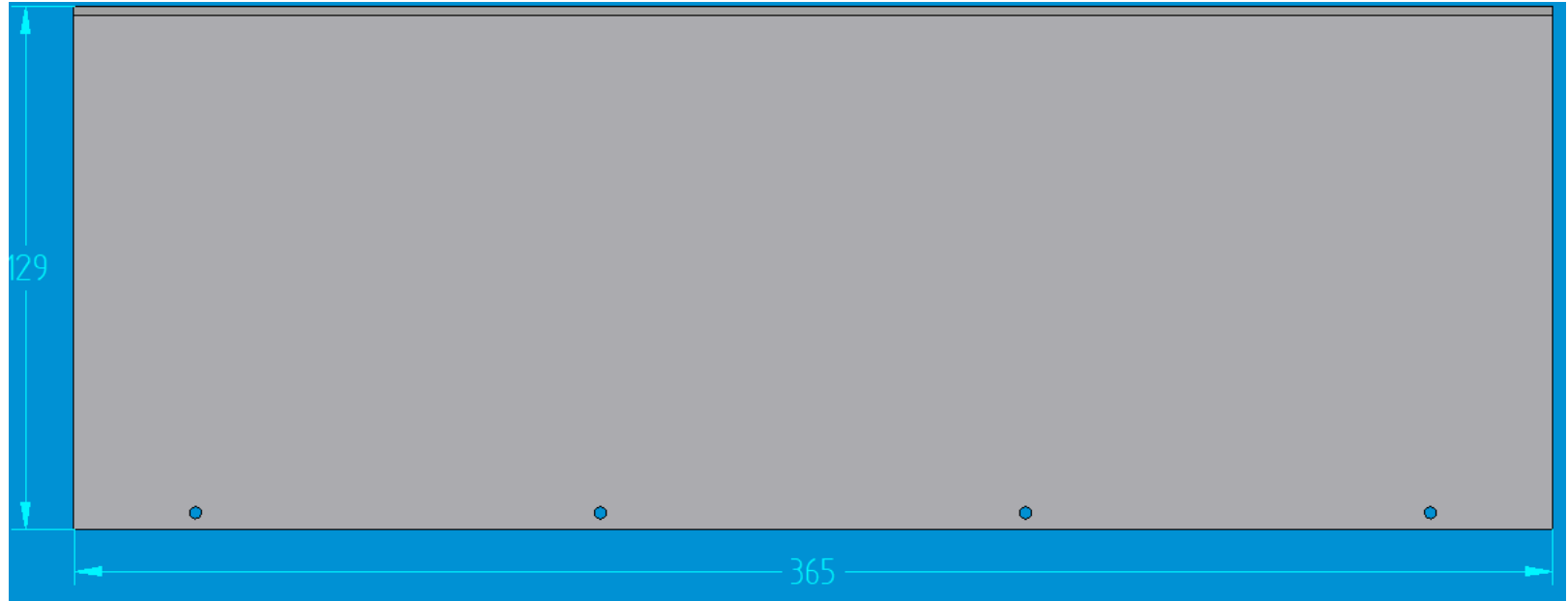
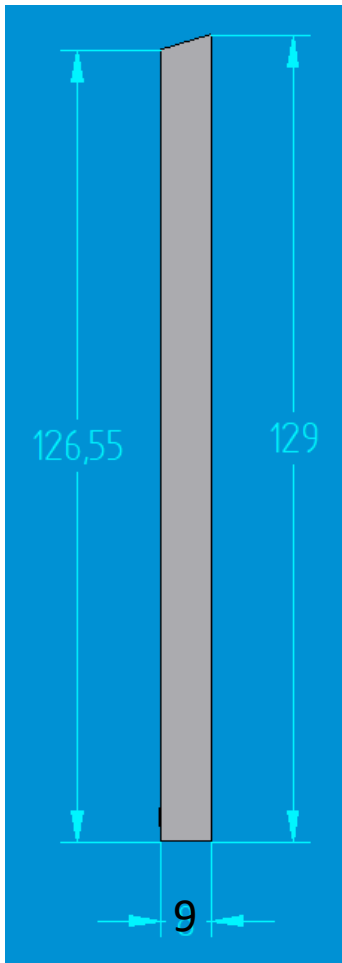

View from inside the case

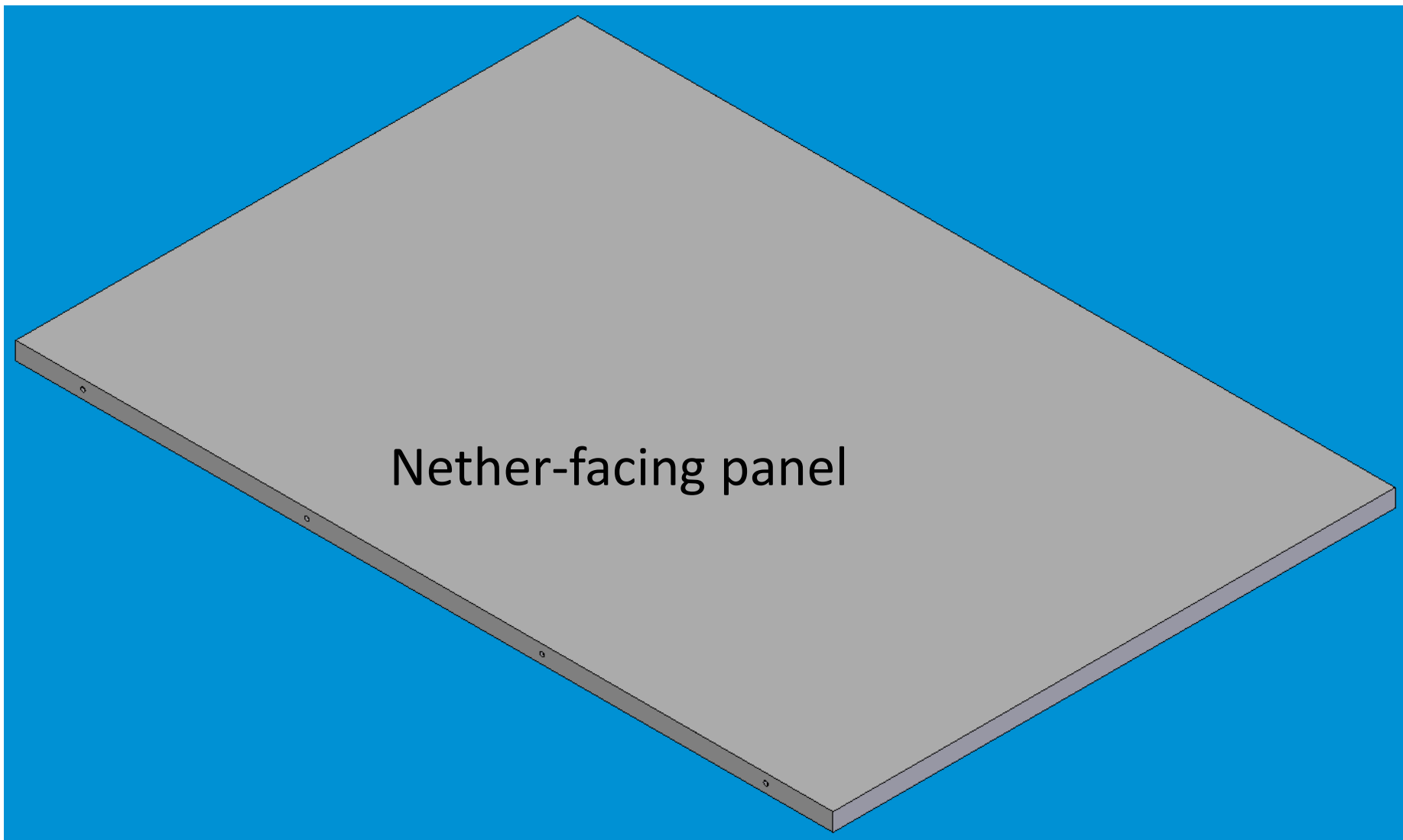

Nether-facing panel

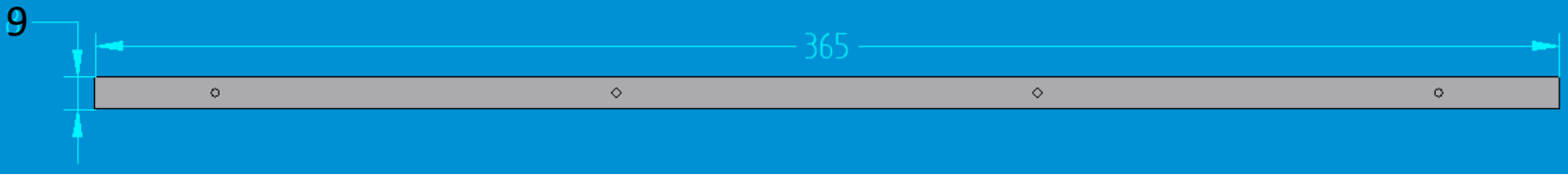

View from front

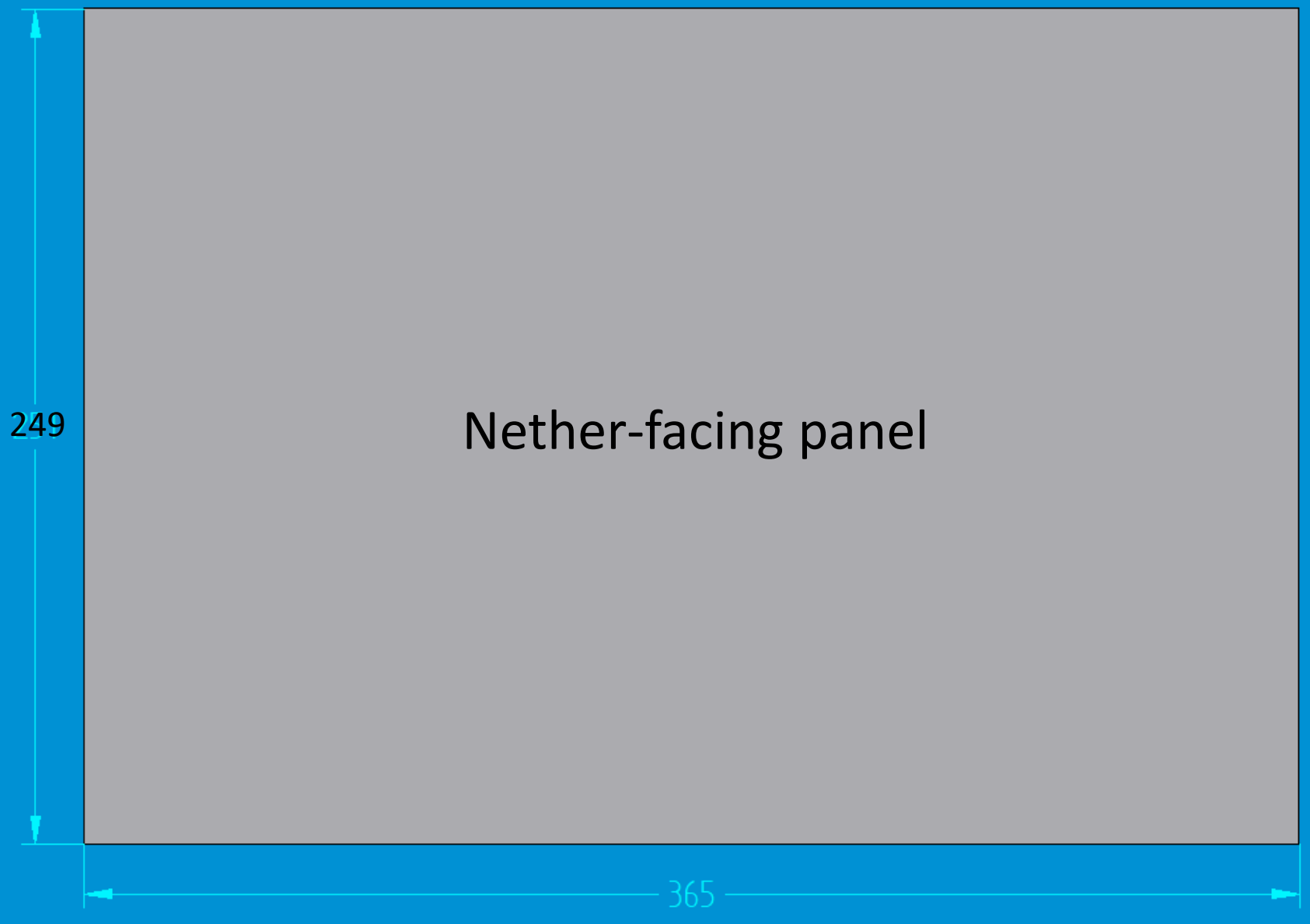

View from top