

clk2a2clk

Midiclock 2 Audio Converter, Audio 2 Midiclock Converter

4 Recording a Midiclock on a Audio-Track on your Multitrack-Recording-Device

in order to get the possibility to overdub a sequencer track on Recording Devices without Midi-Clock builtin

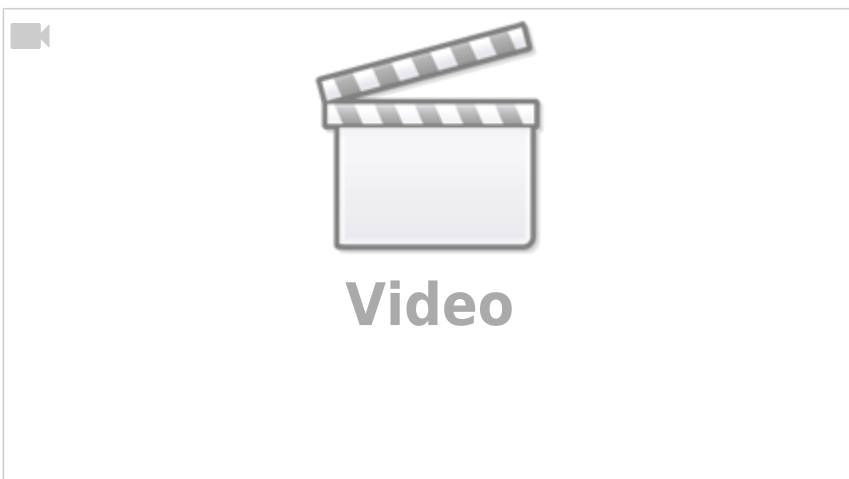



Introduction

i use a zoom livetrack-l12, a multitrack-audio-recorder: compact design, severell submixes, parametric eqs, compressor, efx and a master-track-recording, a good price... AND it doesnt have midi... it does not do midiclock. so when i have to make a track new, or i want to overdub a track, a track that is Midiclock-Driven a sequencer track for example...

So with this device, i lose one Audio-Track, because i use this one Audio-Track, as a Click-Track, it records Audio-Rectangle-Pulses, which are a converted Midiclock-Pulses



when i then playback the Click-Track-Recording, it converts this Audio Pulses back to Midiclock-Messages.

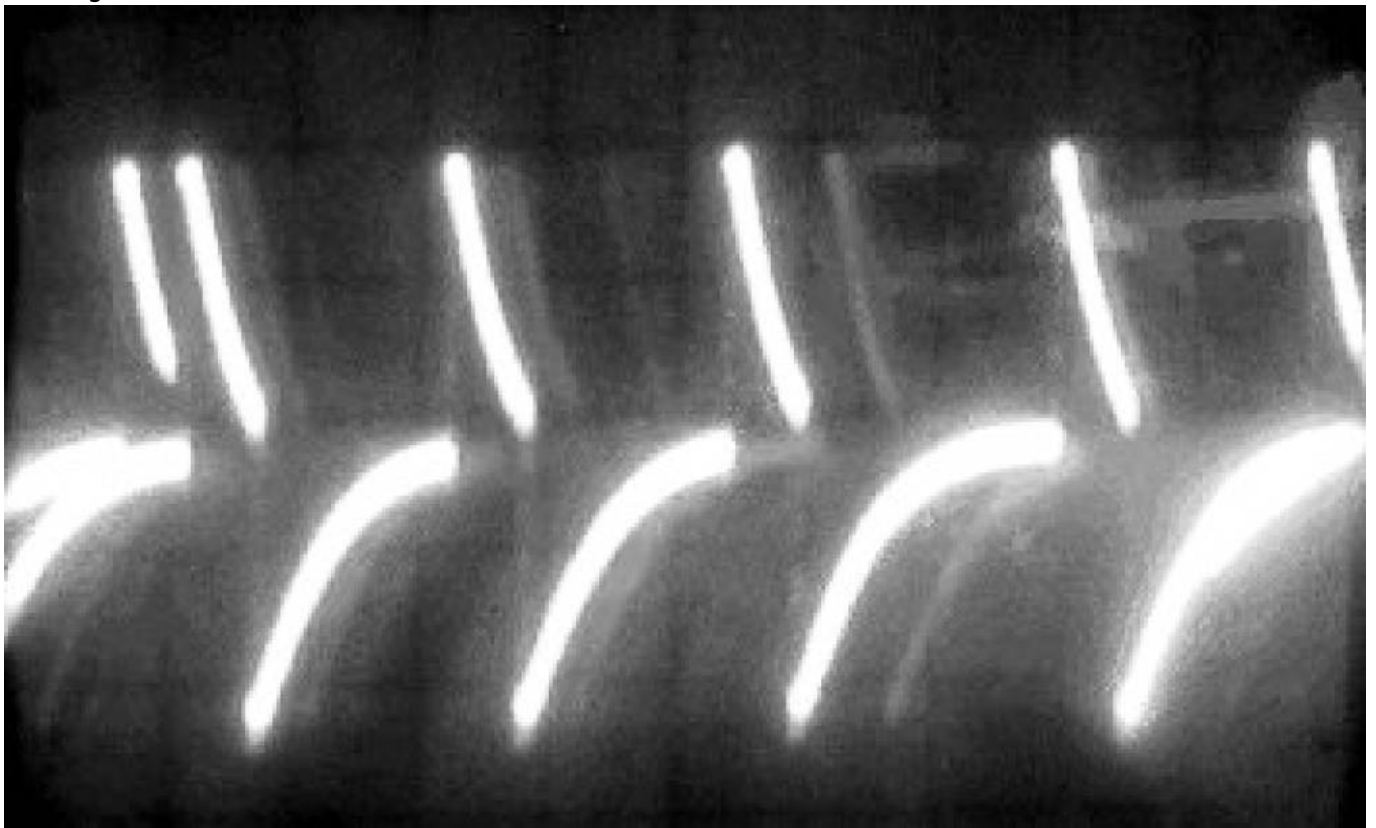

Thats all, not much code, stripped down, running thight.

Features

- convert **Midi-Clock-Data to Audio-Pulses**
- convert Audio-Pulses to Midi-Clock-Data

Hardware Requirements

External Requirement:(for example)

- Clock Source aka Sequencer: [midibox_seq_v4l](#)
- a Synth: JP8080
- a Multitrack-Audio-Recorder: Zoom Livetrack L12
- 3x Midi-Cables

Building FABRICATED PCB

for DIY on Protoboard - see below "Building DIY"

The Design is optimized for Pick and Place most SMD Parts are on the Back-PCB

i ordered 5 PCBs from JLCPCB with almost all SMD Parts (except Thruholes and the PTC) presoldered

now waiting for Presoldered PCBs 🤖 - for 8€ a Piece!

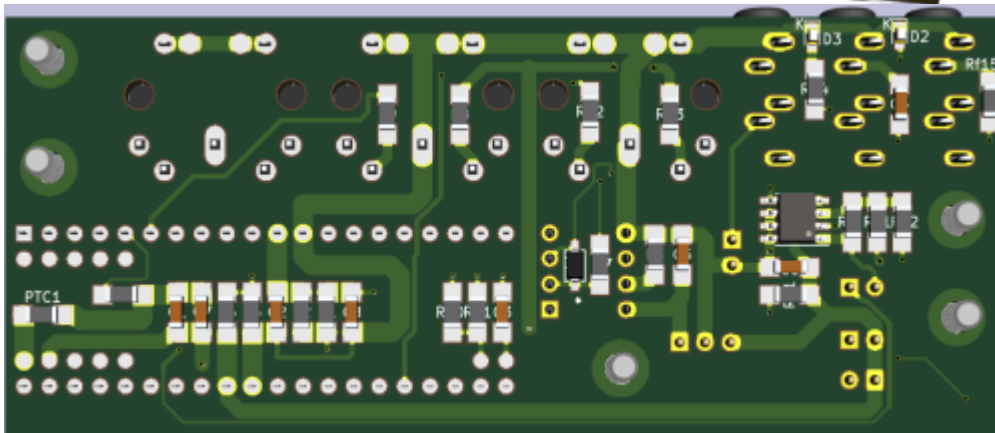
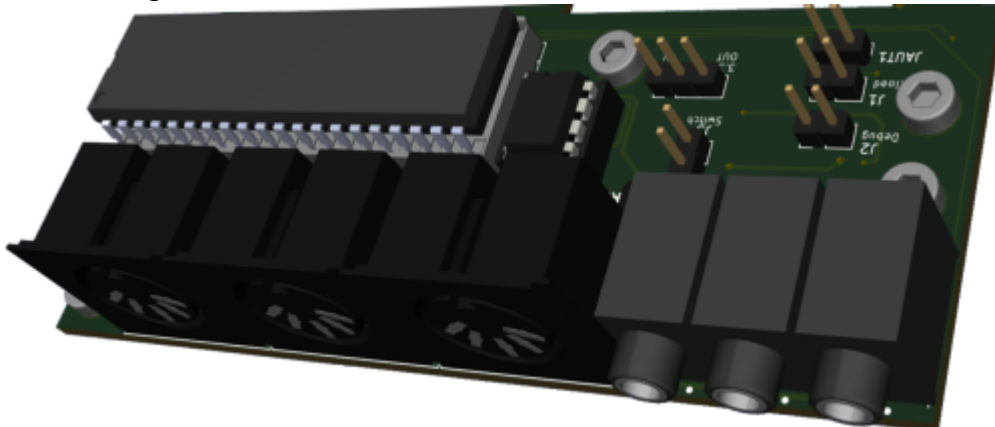

Building DIY

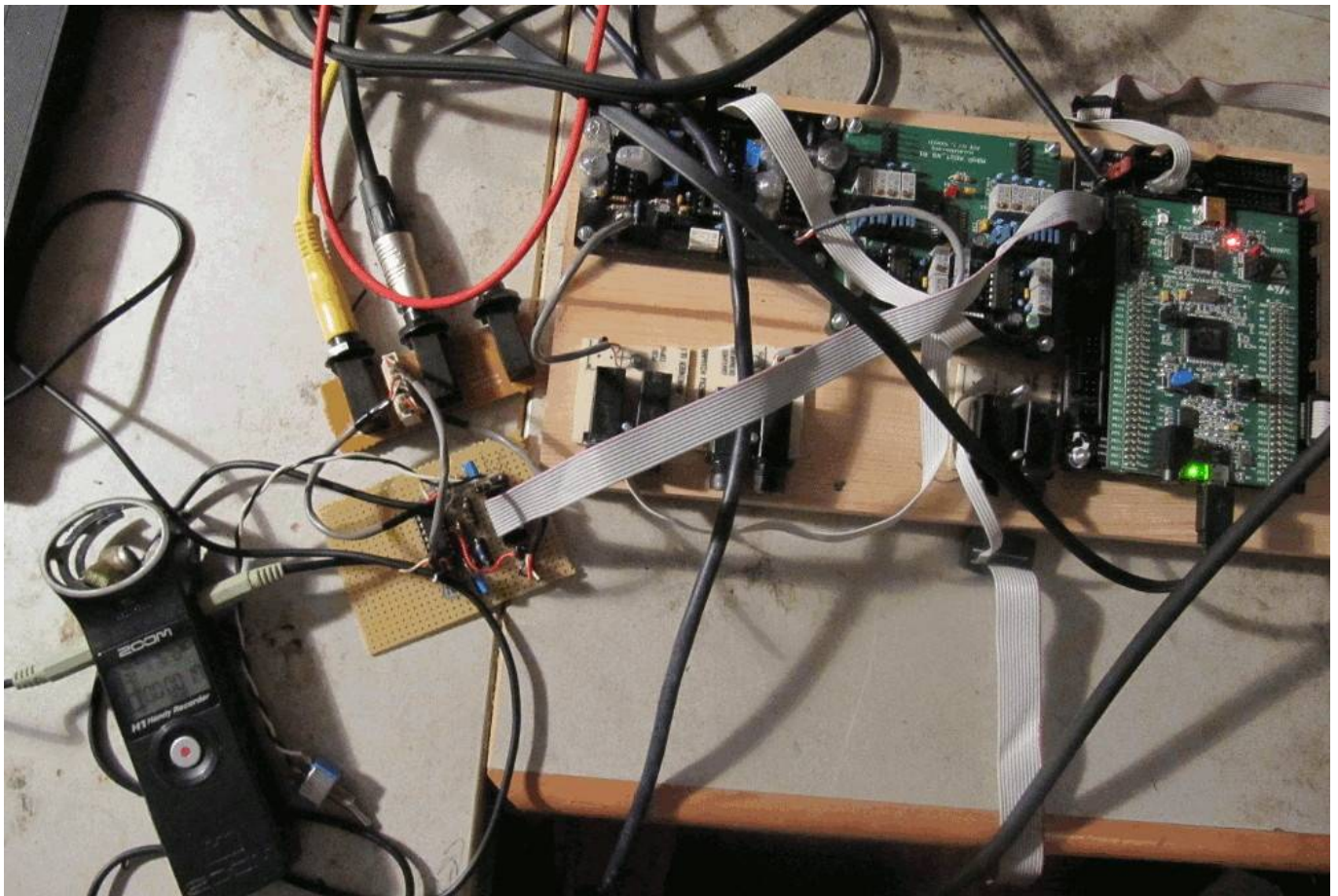

Midibox:

- [core32](#)
- [1xMidi IO](#)
- Soldering Iron, Wires, PCB....
- USB Power Supply

Schmitt-Trigger:

- TS-274 OP-Amp
- 14 Pin - DIP-Socket
- Pin-Header 2x5Pins (to connect the PCB to Core J5A)(you will also need a cable 4 that)
- Resistor R1 20K
- Resistor R2 4K7
- Resistor RFB 100K
- Resistor for Output-Gain-Reduction 100K
- 2x Electrolyt Capacitor 0,67uF (to decouple audio in and out)
- Electrolyt Capacitor 10uF for Supply
- Capacitor 100nF to denoise the OP-Amps-Rails...
- 2 Audio Cables+Sockets for the connection to the Recorder (6,3 mono jacks)

on Protoboard

here i have made it all on protoboard:

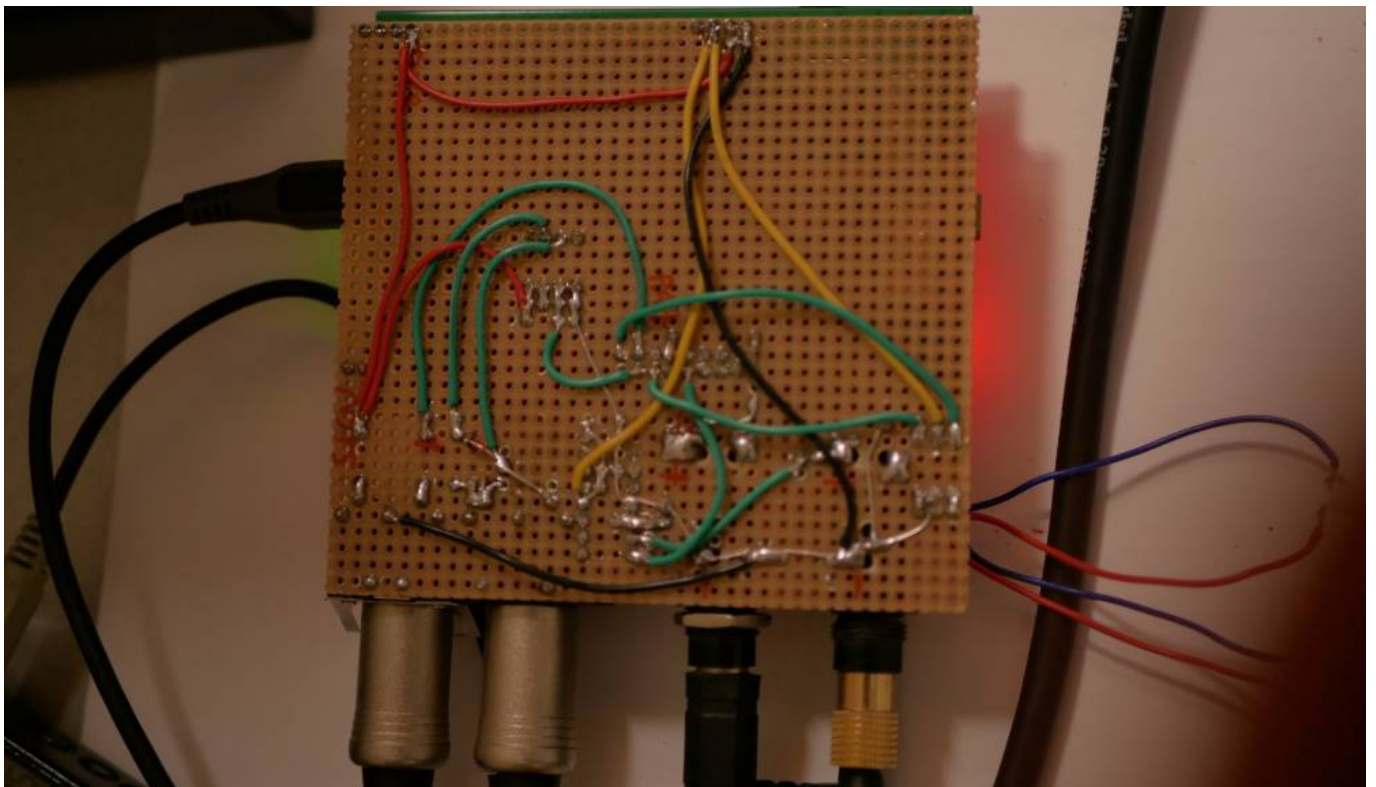
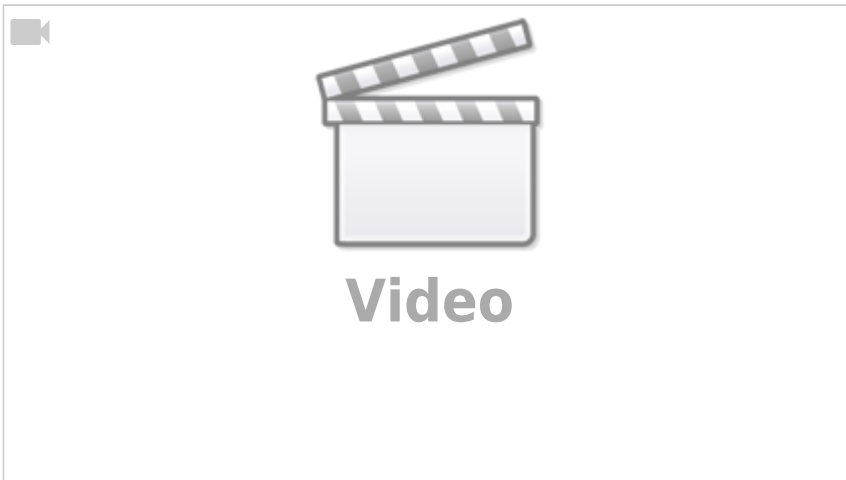

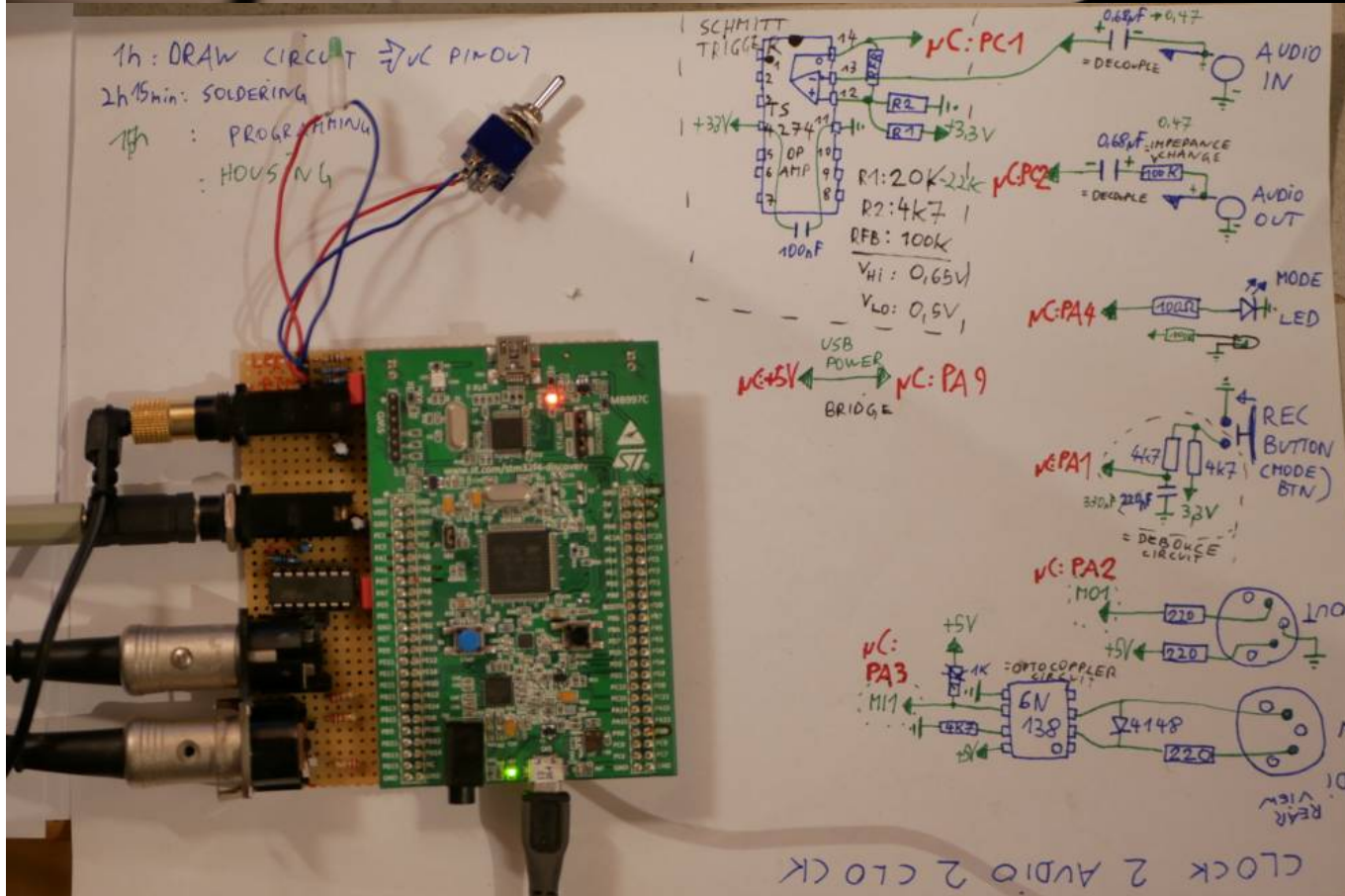
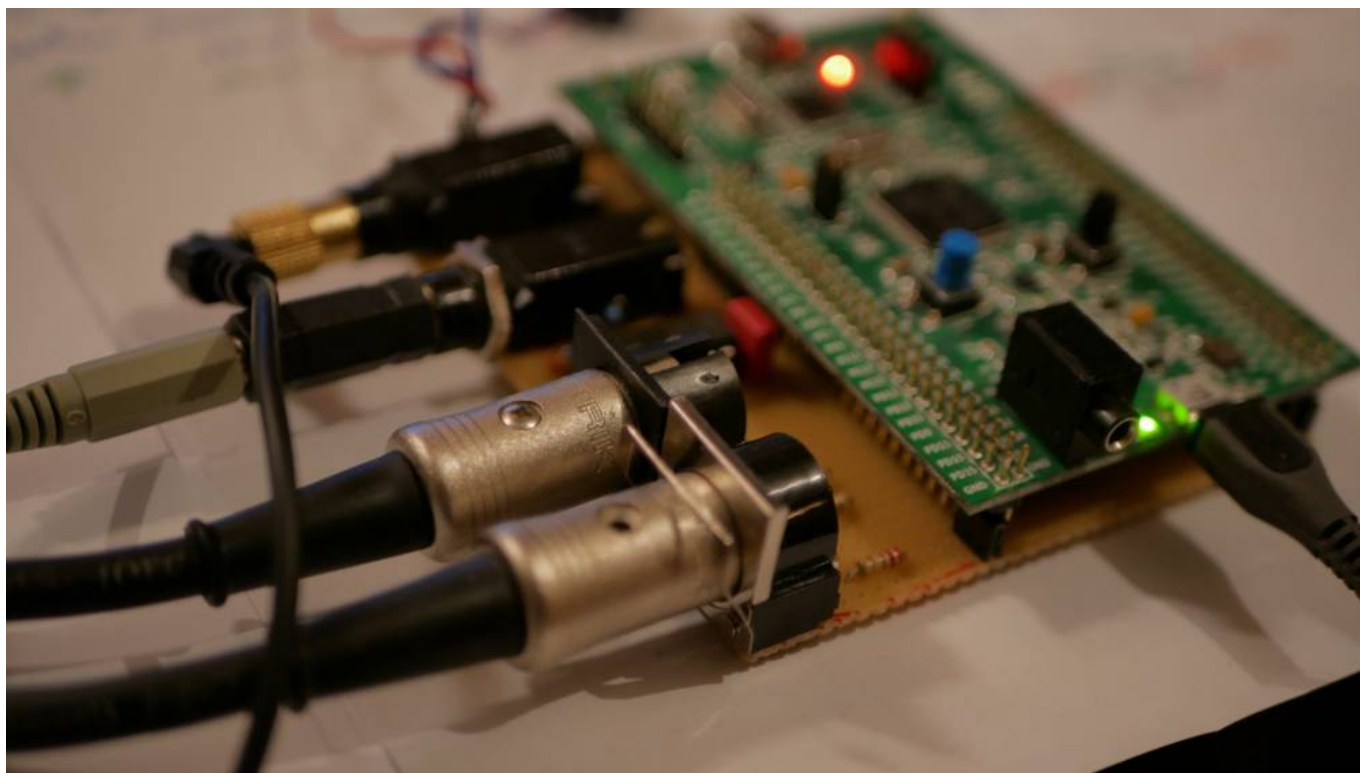

Firmware

V1.2017clk2a2clk.zip hardcodet no menu, no nothing, stripped down to max performance

How I Use It - built in Rack



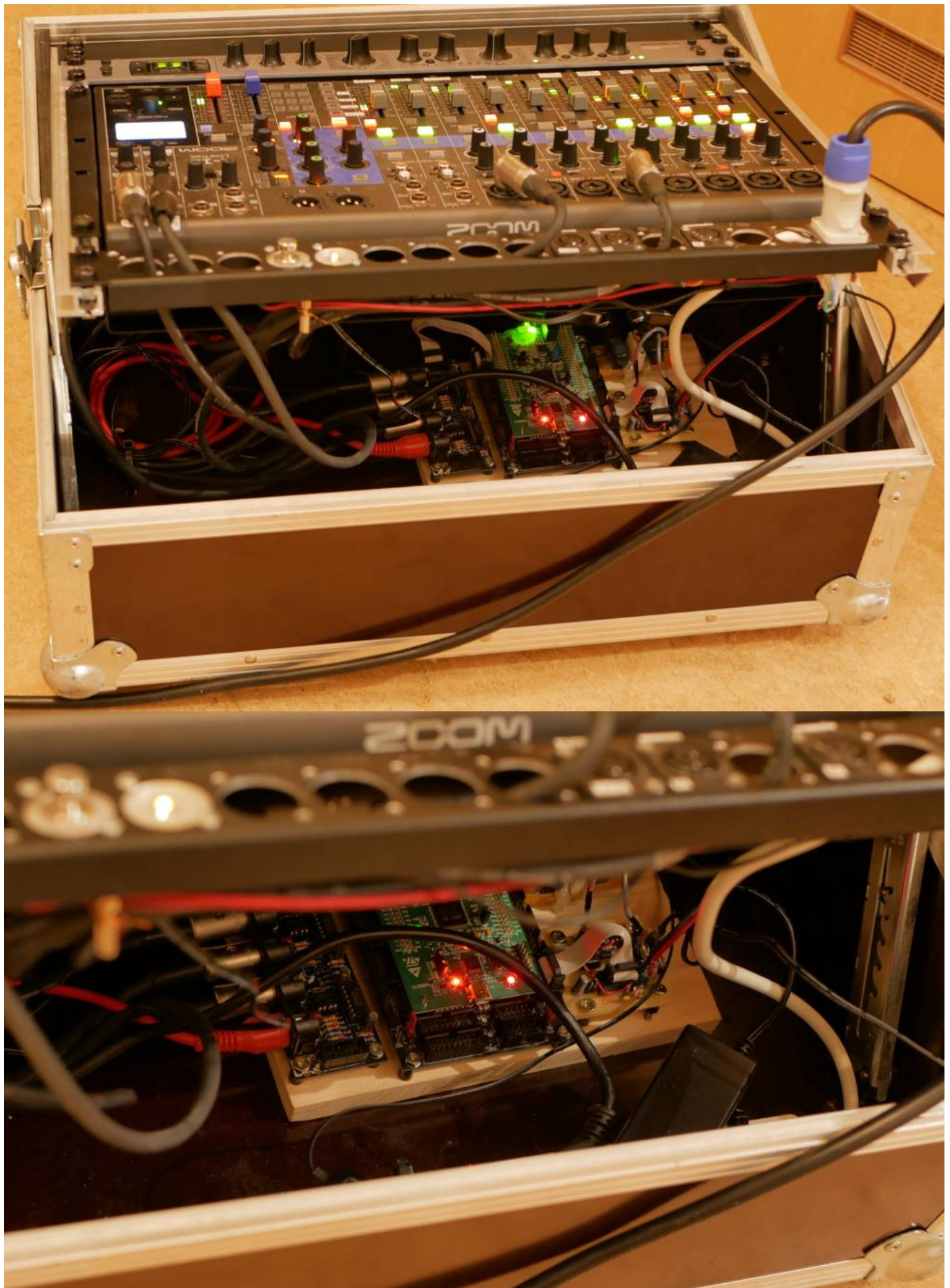

Resources

[Schmitt-Trigger-Calculator](#)

Community users working on it

- **Phatline** = Programming, Documentation...

Just let a Private message on the forum to user already involved

From:

<https://wiki.midibox.org/> - **MIDIbox**

Permanent link:

<https://wiki.midibox.org/doku.php?id=clock2audio2clock&rev=1609637586>

Last update: **2021/01/03 01:33**

