

# clk2a2clk

Midiclock 2 Audio Converter, Audio 2 Midiclock Converter

4 Recording a Midiclock on a Audio-Track on your Multitrack-Recording-Device

in order to get the possibility to overdub a sequencer track on Recording Devices without Midi-Clock builtin





## Introduction

i use a zoom livetrack-l12, a multitrack-audio-recorder: compact design, severell submixes, parametric eqs, compressor, efx and a master-track-recording, a good price... AND it doesnt have midi... it does not do midiclock. so when i have to make a track new, or i want to overdub a track, a track that is Midiclock-Driven a sequencer track for example...

So with this device, i lose one Audio-Track, because i use this one Audio-Track, as a Click-Track, it records Audio-Rectangle-Pulses, which are a converted Midiclock-Pulses



when i then playback the Click-Track-Recording, it converts this Audio Pulses back to Midiclock-Messages.



Thats all, not much code, stripped down, running thight.

## Features

- **convert Midi-Clock-Data to Audio-Pulses**
- convert Audio-Pulses to Midi-Clock-Data

# Hardware Requirements

**External Requirement:**(for example)

- Clock Source aka Sequencer: [midibox\\_seq\\_v4l](#)
- a Synth: JP8080
- a Multitrack-Audio-Recorder: Zoom Livetrack L12
- 3x Midi-Cables

# Schematic

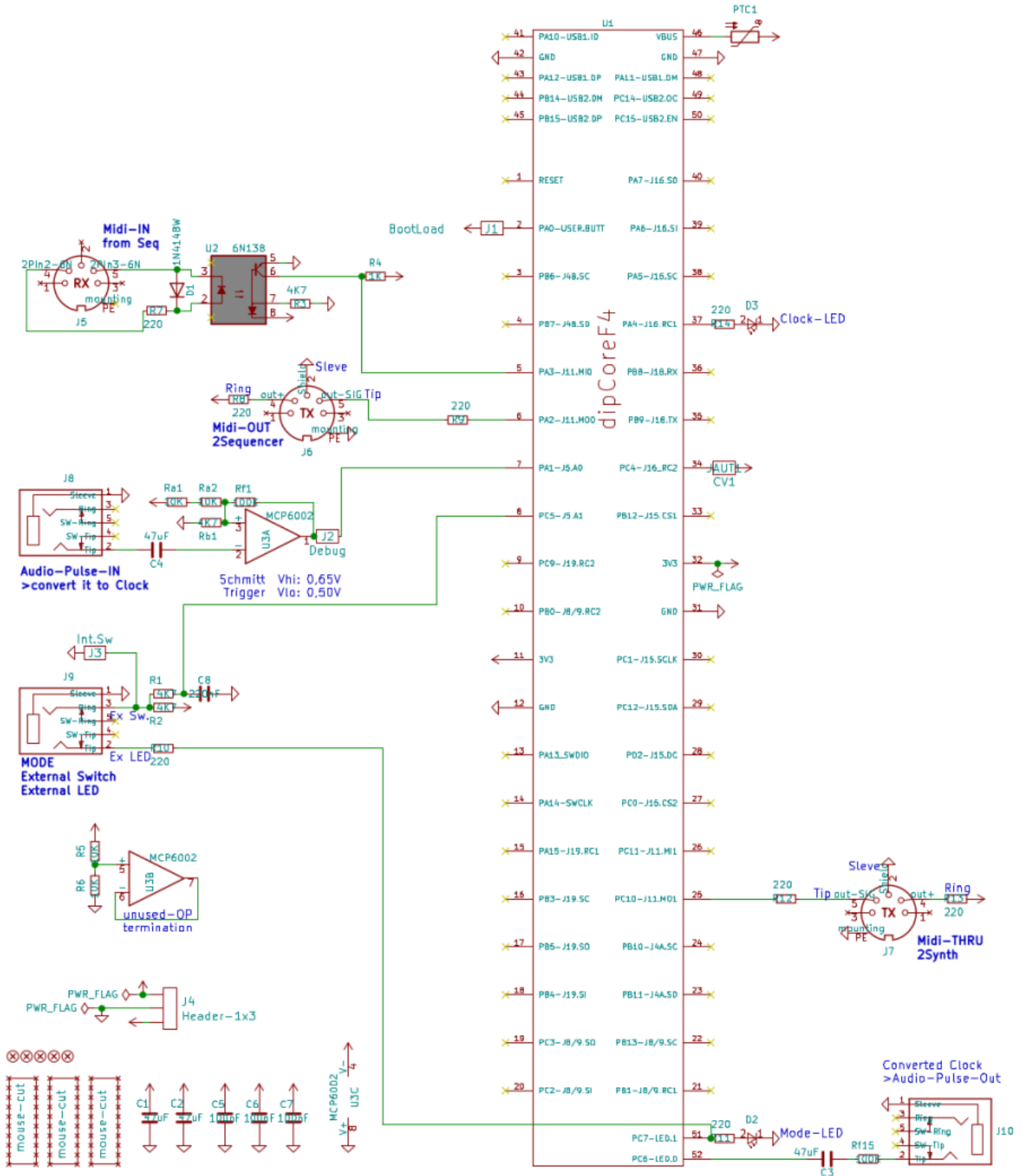

# Building FABRICATED PCB

for DIY on Protoboard - see below "Building DIY"

The Design is optimized for Pick and Place most SMD Parts are on the Back-PCB

i ordered 5 PCBs from JLCPCB with almost all SMD Parts (except Thruholes and the PTC) presoldered

now waiting for Presoldered PCBs  - for 8€ a Piece!

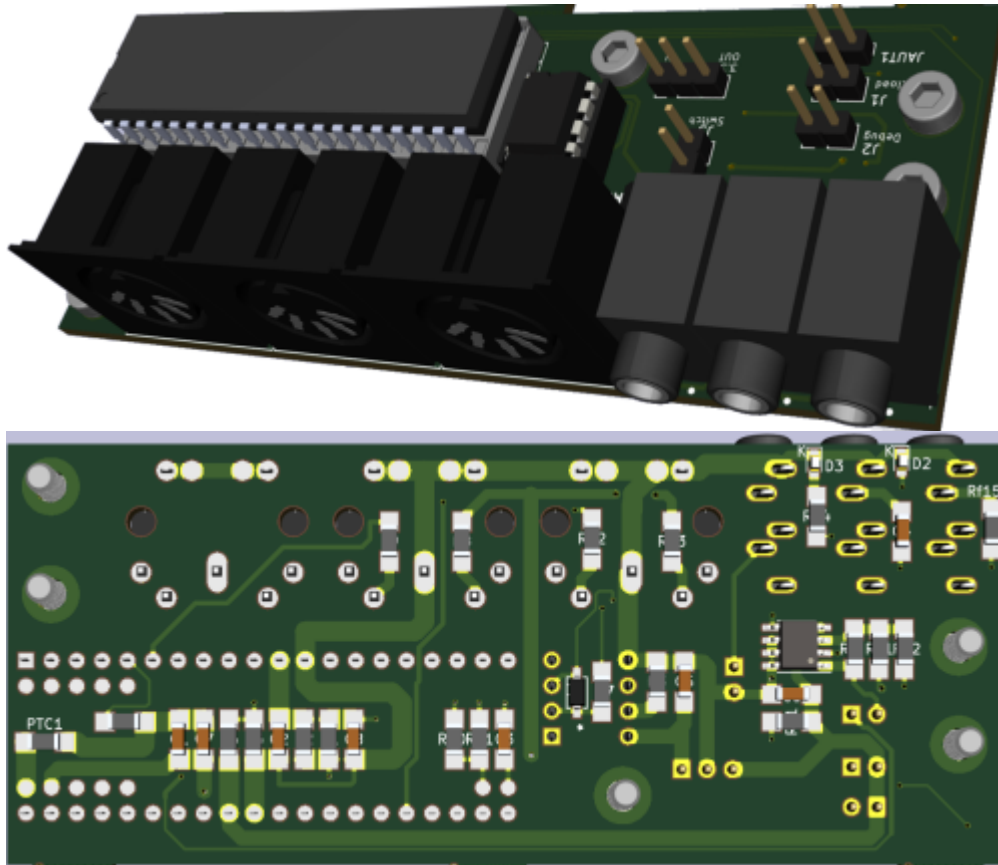

## BOM

Value	Designator	Footprint	LCSC Part Number	Library-Type	Mouser
47uF	C1,C2,C3,C4	midibox:1206-C	C96123	basic	
100nF	C5,C6,C7	midibox:1206-C	C24497	basic	
220nF	C8	midibox:1206-C	C1857	basic	
1N4148W	D1	midibox:SOD123-DIODE	C81598	basic	
LED-Yellow	D2,D3	midibox:0603-LED	C72038	basic	
BootLoad	J1	midibox:Header-1x2			
Debug	J2	midibox:Header-1x2			
Int.Sw	J3	midibox:Header-1x2			
Header-1x3	J4	midibox:Header-1x3			
Midi-DIN-5-Socket_RX	J5	midibox:Midi-DIN5-MAB55H			806-KCDX-5S-S2
Midi-DIN-5-Socket_TX	J6,J7	midibox:Midi-DIN5-MAB55H			806-KCDX-5S-S2
3.5Jack	J8,J9,J10	midibox:35JACK-CUI_SJ1-3535NG-PI			490-SJ1-3535NG
CV1	JAUT1	midibox:Header-1x2			
Mounting-Hole	M0,M1,M2,M3,M4	midibox:Mounting-Hole-M3			
PTC	PTC1	midibox:1206-R	C126818	extended	576-1206L150THWR
4K7	Rb1,R1,R2,R3	midibox:1206-R	C17936	basic	
1K	R4	midibox:1206-R	C4410	basic	
220	R7,R8,R9,R10,R11,R12,R13,R14	midibox:1206-R	C17958	basic	
10K	Ra1,Ra2,R5,R6	midibox:1206-R	C17902	basic	
100K	Rf1,Rf15	midibox:1206-R	C17900	basic	
DIPCOREF4_52P	U1	dipcore-V2C:dipCoreF4_v2c-52p-DIP-40-CMPNT_CORE_52P	@Antichambre		
6N138	U2	midibox:DIP-8			512-6N138M
MCP6002	U3	midibox:SOP-8_SOIC-8	C7377	basic	
mouse-cut	cut1,cut2,cut3	midibox:mouse-cut			

## Building DIY

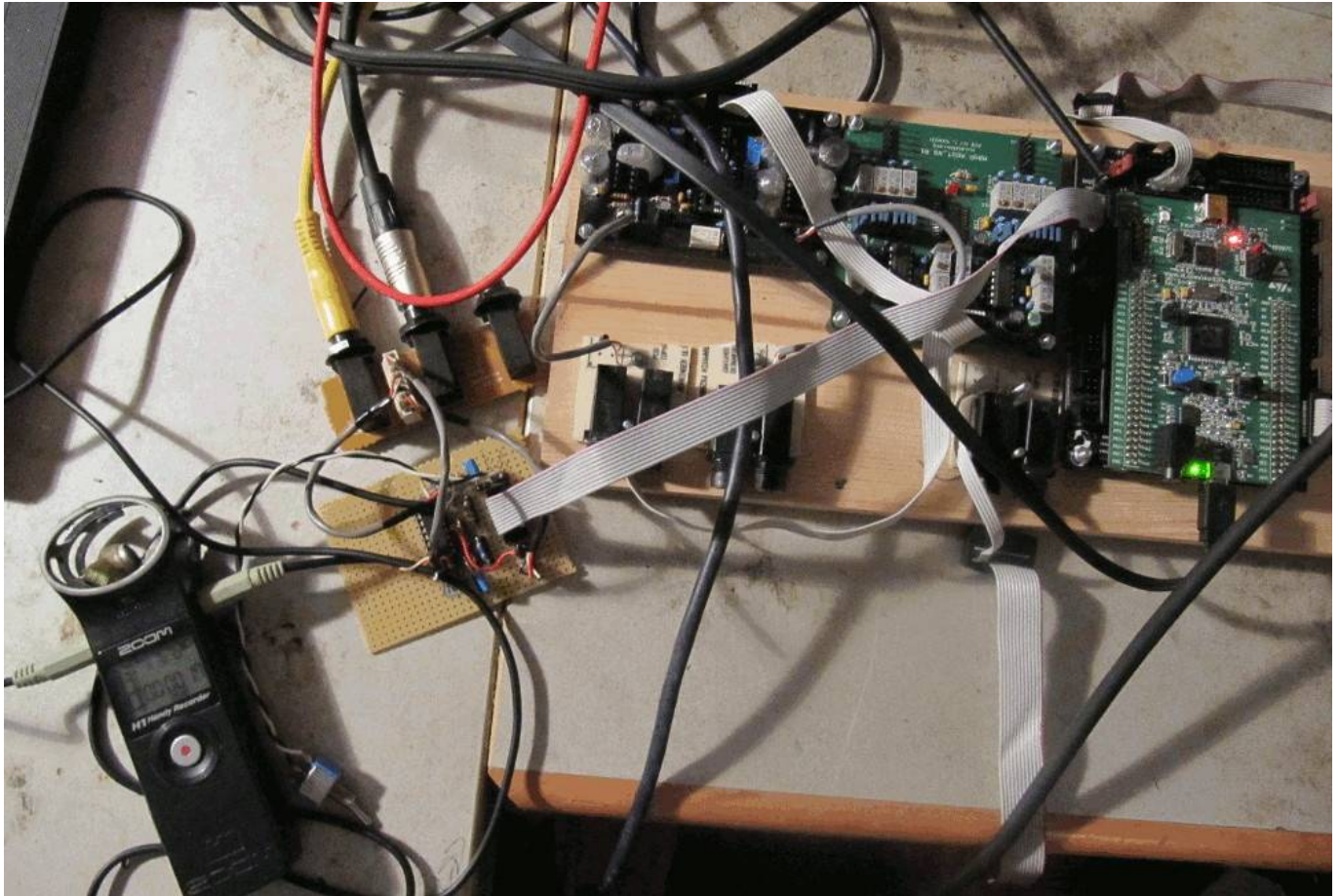

### Midibox:

- [core32](#)
- [1xMidi IO](#)
- Soldering Iron, Wires, PCB....
- USB Power Supply

### Schmitt-Trigger:

- TS-274 OP-Amp
- 14 Pin - DIP-Socket
- Pin-Header 2x5Pins (to connect the PCB to Core J5A)(you will also need a cable 4 that)
- Resistor R1 20K
- Resistor R2 4K7
- Resistor RFB 100K
- Resistor for Output-Gain-Reduction 100K
- 2x Electrolyt Capacitor 0,67uF (to decouple audio in and out)
- Electrolyt Capacitor 10uF for Supply
- Capacitor 100nF to denoise the OP-Amps-Rails...
- 2 Audio Cables+Sockets for the connection to the Recorder (6,3 mono jacks)

## on Protoboard

here i have made it all on protoboard:

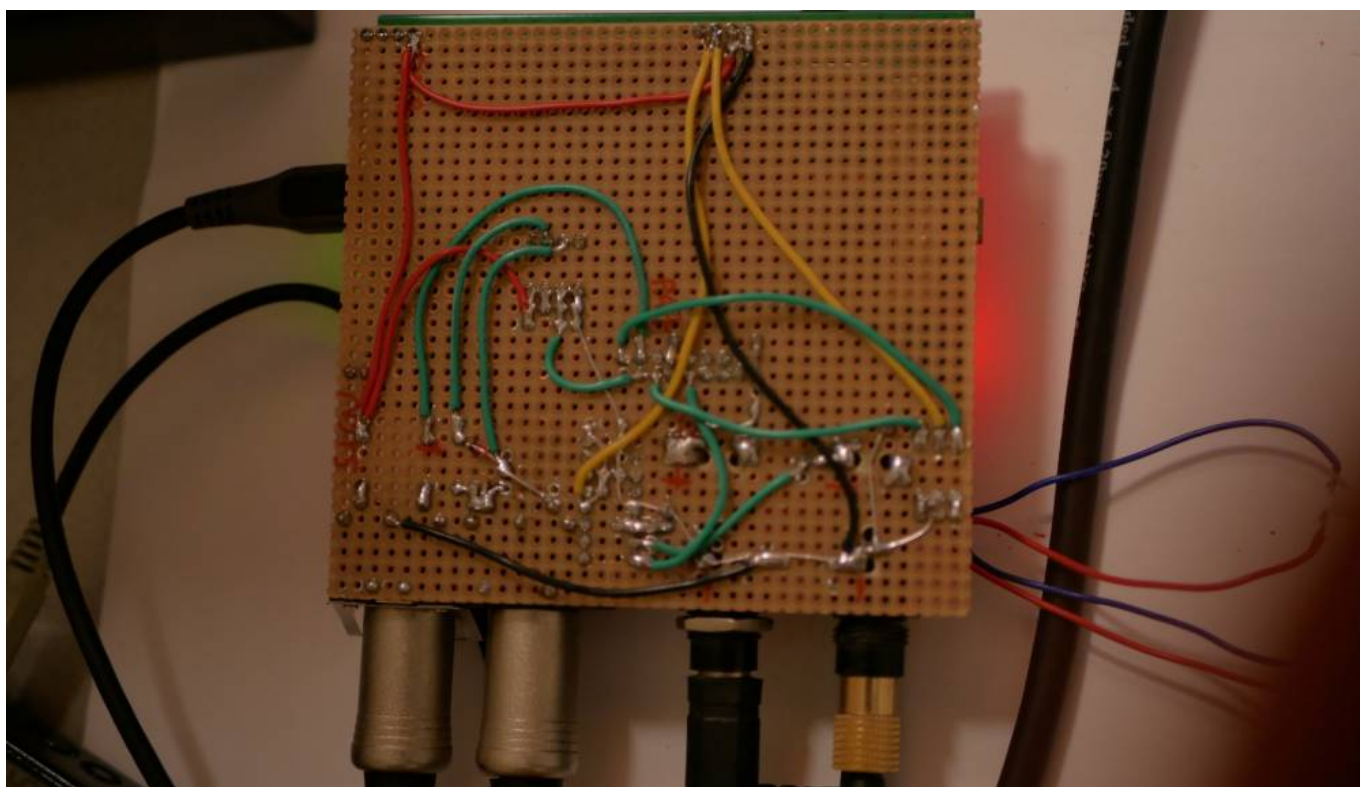
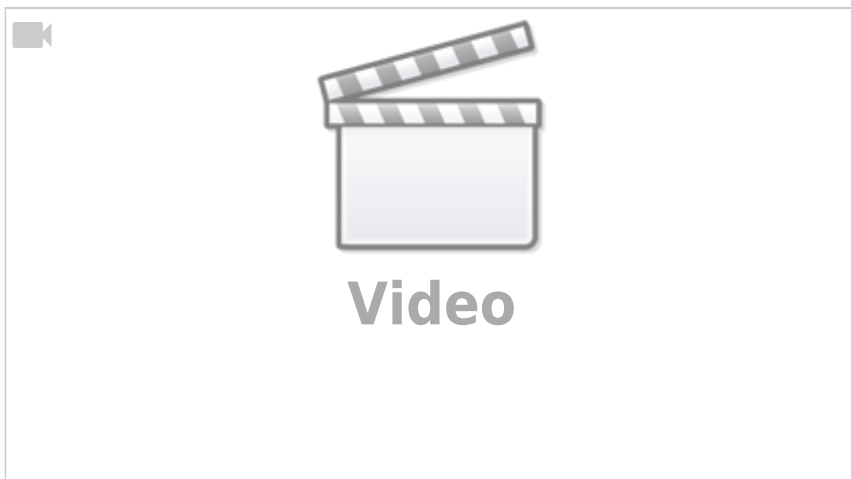

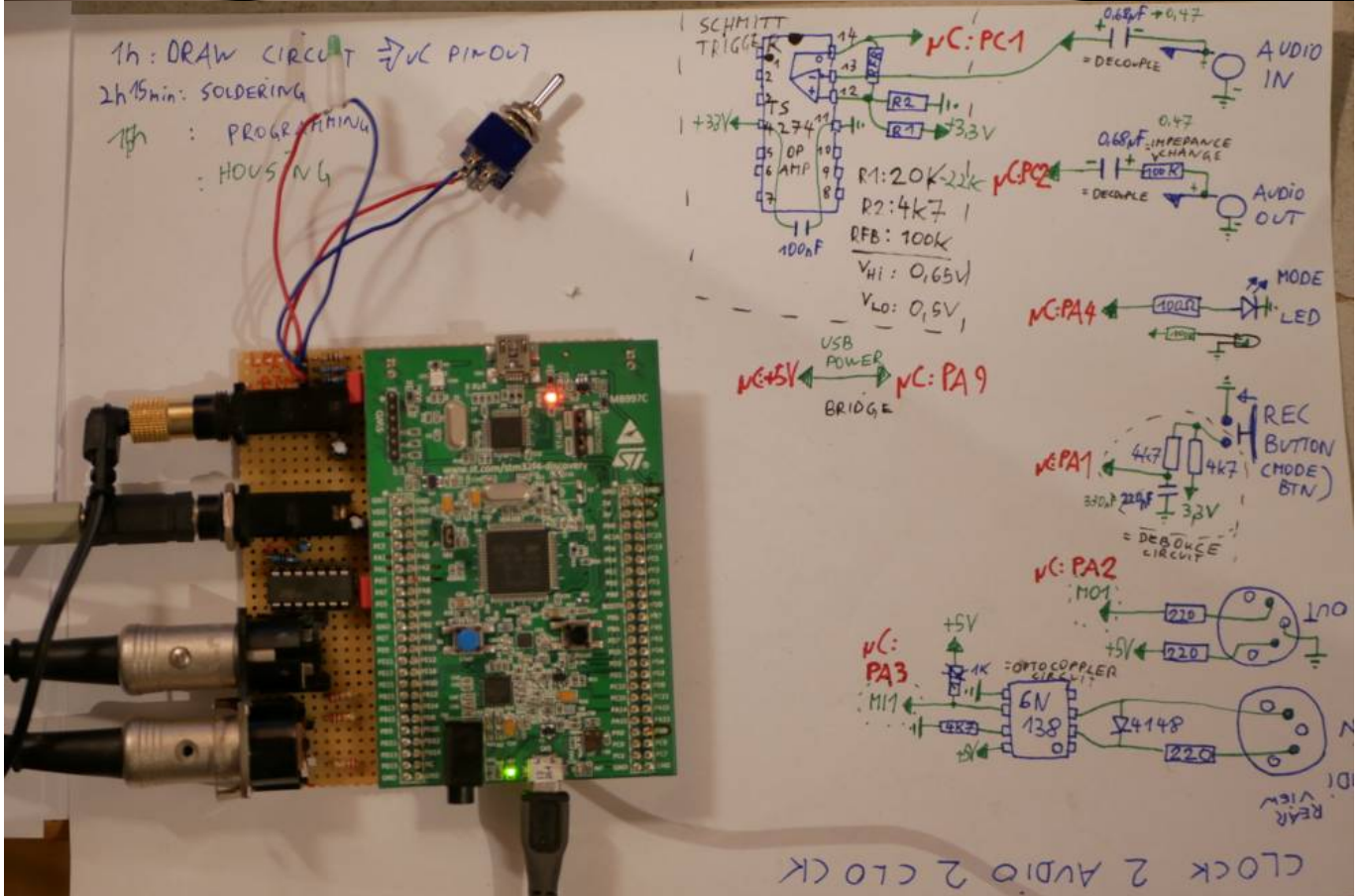
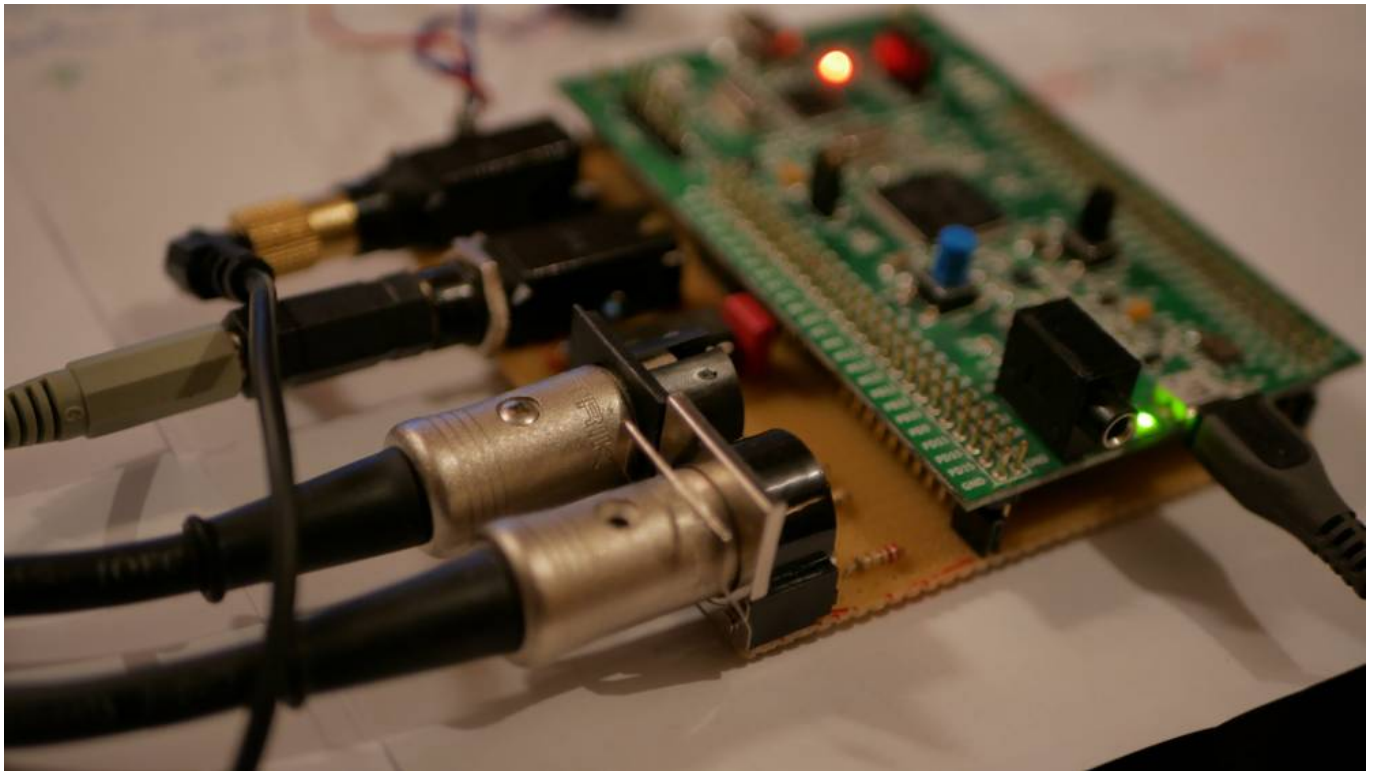

# Firmware

V1.2017clk2a2clk.zip hardcodet no menue, no nothing, stripped down to max performance

# How I Use It - built in Rack



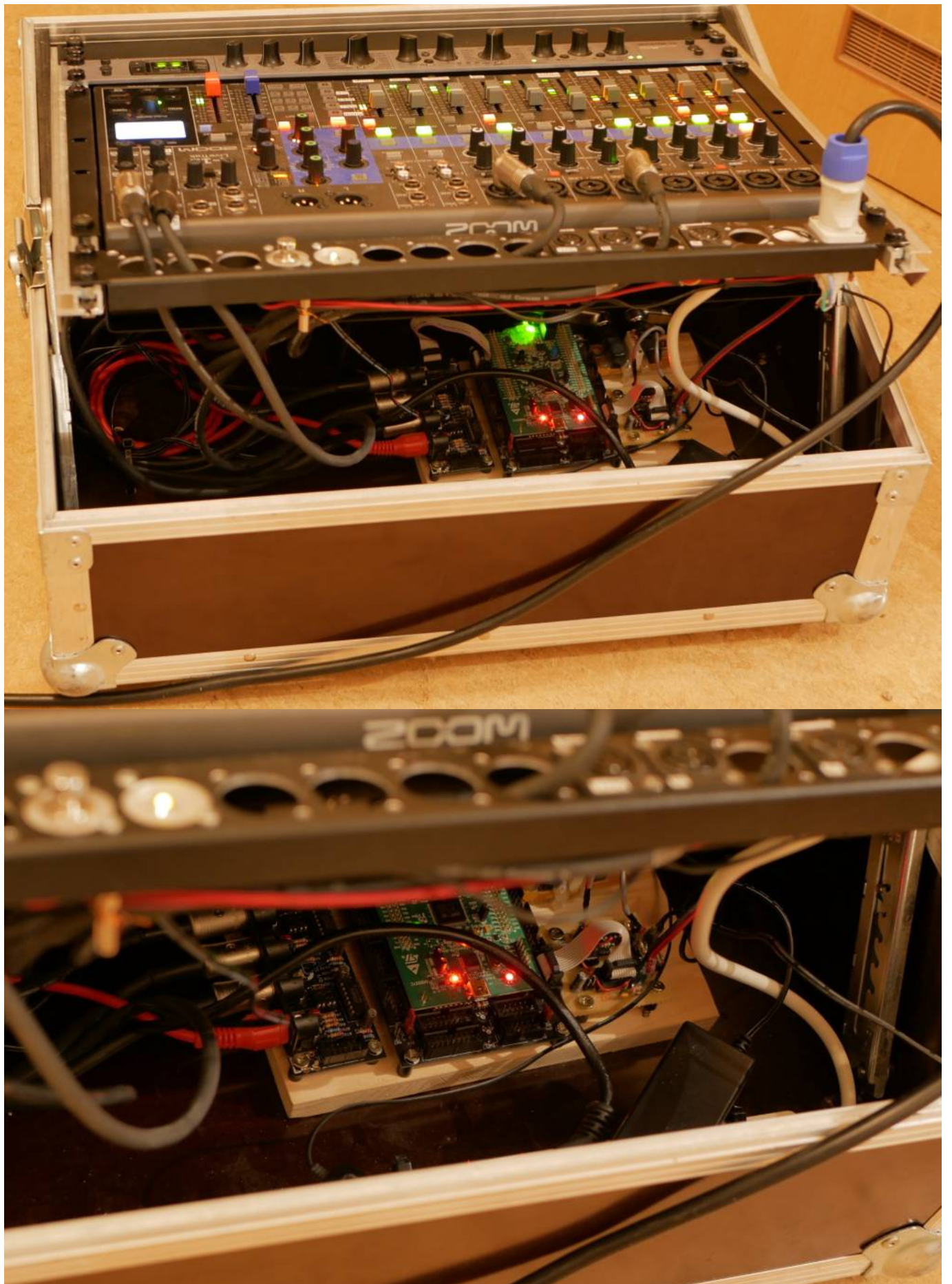

## Resources

[Schmitt-Trigger-Calculator](#)

# Community users working on it

- **Phatline** = Programming, Documentation...

Just let a Private message on the forum to user already involved

From:

<https://wiki.midibox.org/> - **MIDIbox**

Permanent link:

<https://wiki.midibox.org/doku.php?id=clock2audio2clock&rev=1609638186>

Last update: **2021/01/03 01:43**

