

Control Panel for AIN_4 & AOUT_4 v1.2

AIN_4 v1.2 TOP

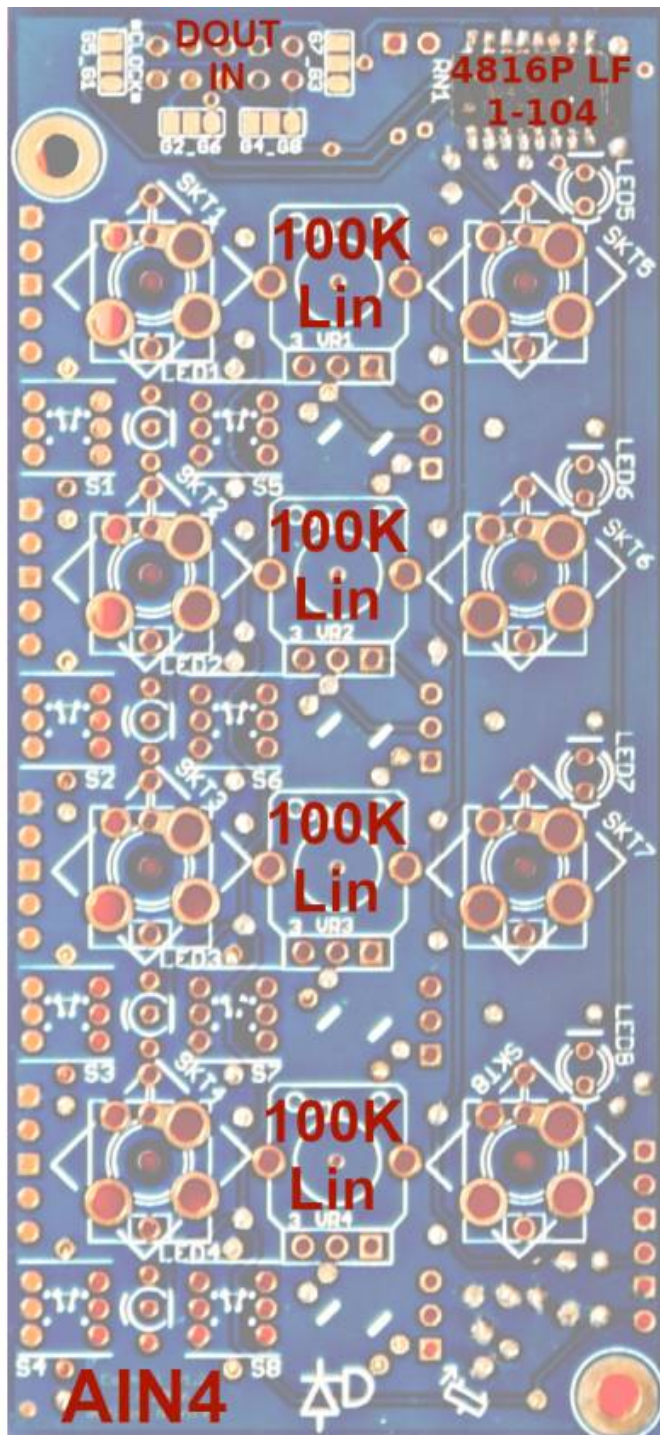

AIN_4 v1.2 BACK

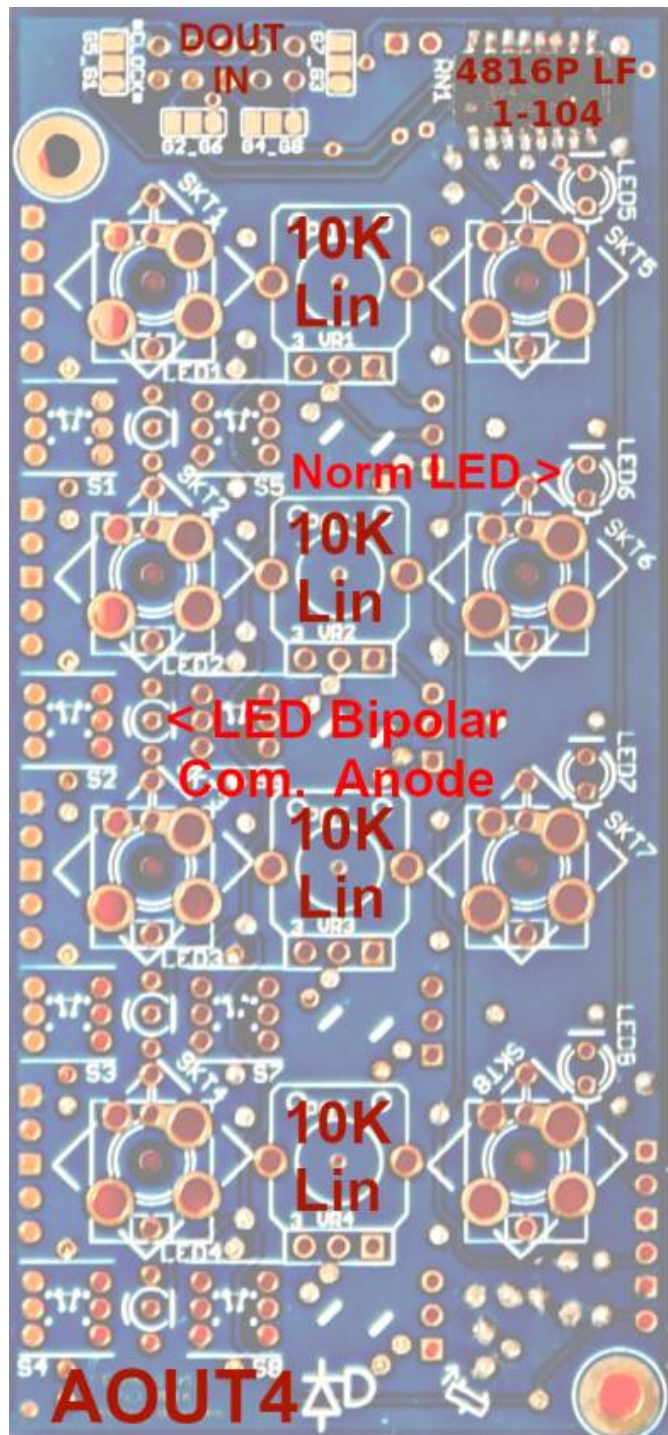
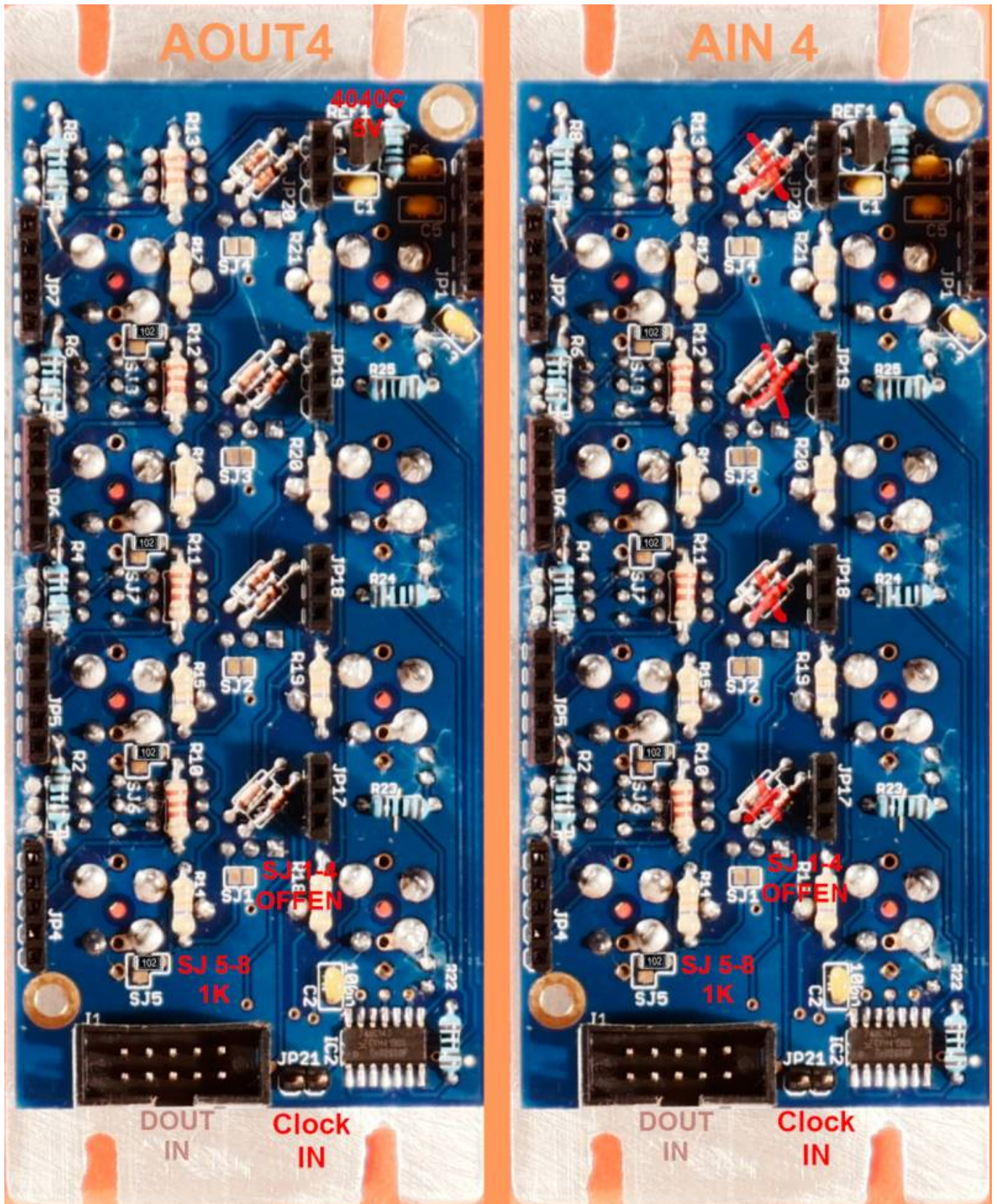

Front-Panel for AIN_4 v1.2

i measured the PCB, and made a drawing in order to create a hand-drilled Frontpanel... so dont take the values as 100% true...:

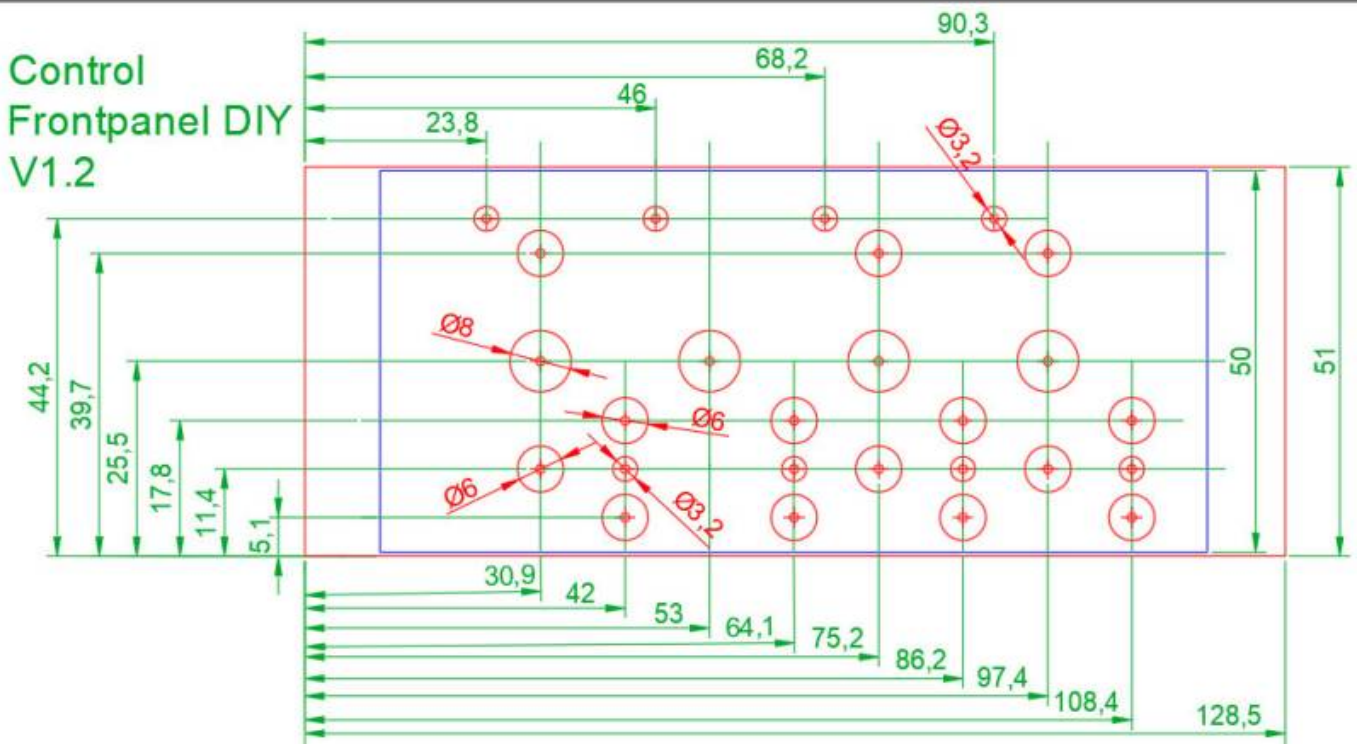
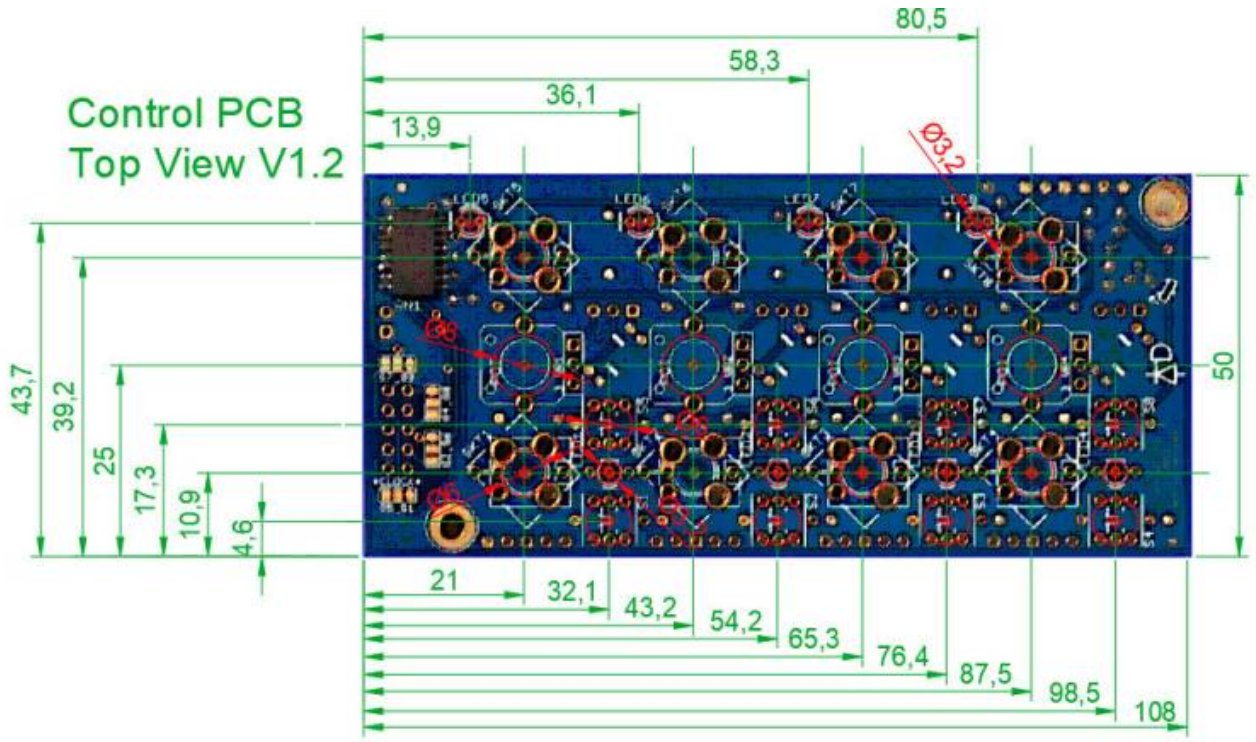



From: <https://wiki.midibox.org/> - **MIDIbox**

Permanent link: https://wiki.midibox.org/doku.php?id=control_board&rev=1641435934

Last update: **2022/01/06 02:25**

