

# dipBoard32

MIDIbox Hardware Platform extension for [dipCore32](#).

## features

- Very small size 65x46mm(less than your credit card).
- Very low profile.
- Your application board can be stacked on bottom with 'Micro-match' connectors.
- The [dipCore32](#) can be installed on the two side.
- Provides all the most important features and ports as a regular mbhp.
- Compatible with Andy's [USB](#) and [RES-SD](#) modules.

## dimension

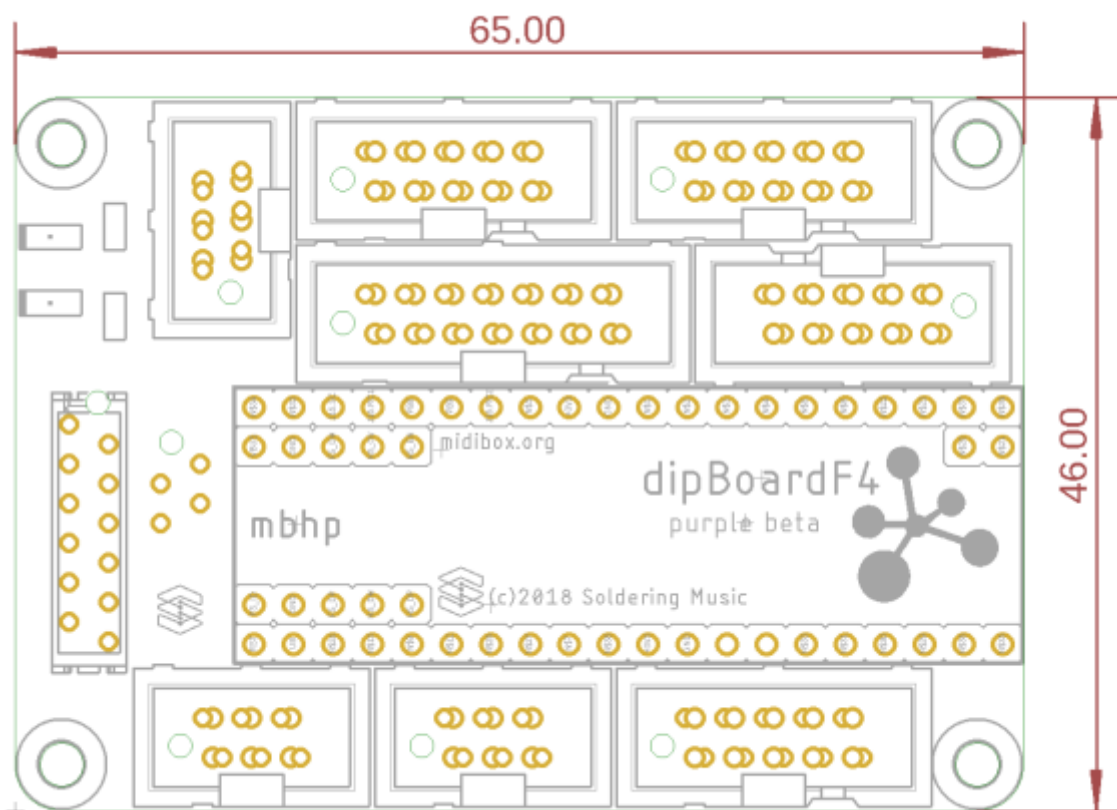

## PCB

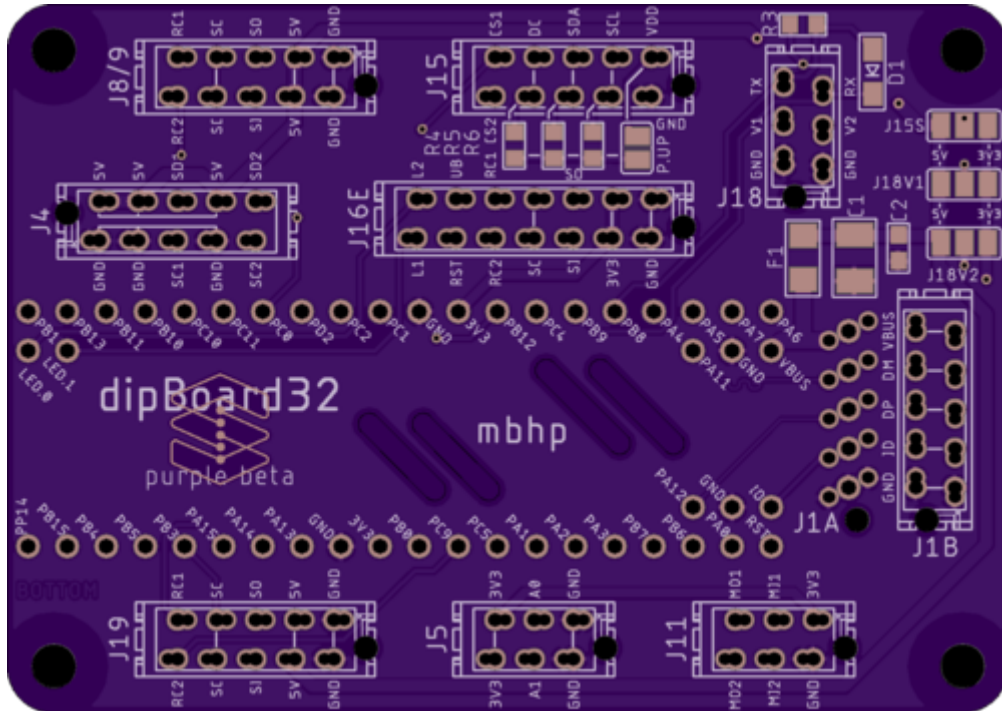

Top copper



Bottom

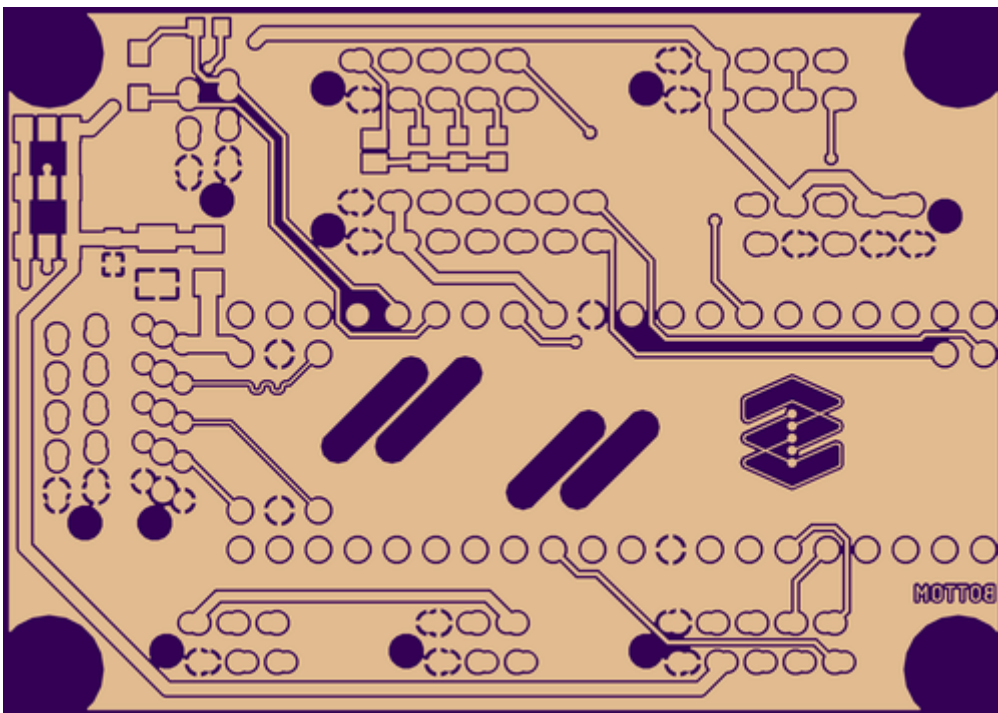

ToDo

From:  
<https://wiki.midibox.org/> - **MIDIbox**

Permanent link:  
<https://wiki.midibox.org/doku.php?id=dipboard32&rev=1535634739>

Last update: **2018/08/30 13:12**

