

dipCoreF4

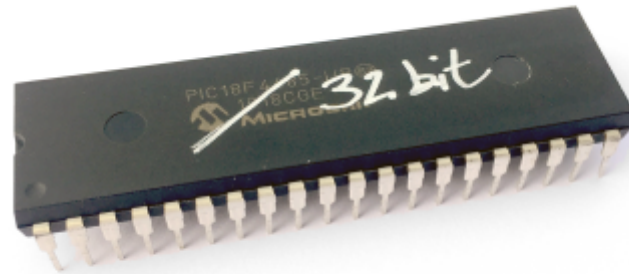

A reduced Core for your MIDIbox App, an STM32F405RG in a DIP40 format.

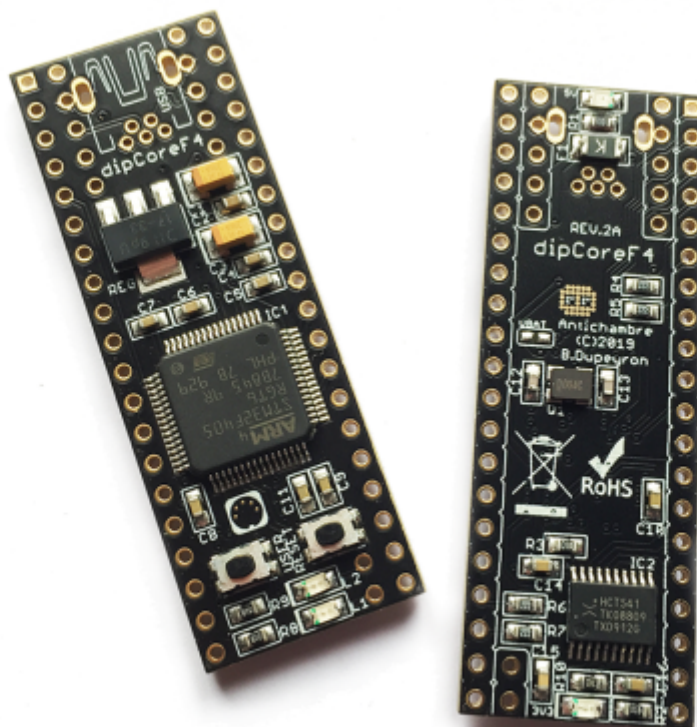

Features

- MIOS32 uses same processor family and drivers(no deep change).
- Same internal hardware as Disco or wCore (speed, memory, peripherals, etc...) .
- Board pinout and package compatible with a MIOS8 PIC 😎
- USB connector onboard. 2 OTG are available, second(new) USB is Host only.

- 5V power input and led.
- 3.3V regulator and led on board.
- 74HCT541 on board for the 5V output ports.
- User and Reset buttons.
- 2 user leds.
- 12 extra pins for USB, buttons and leds.
- Your favorite Core is now a current component easy to integrate.

All commons MIO32 ports are available except:

- General purpose J10x ports were removed.
- LCD port was reduced to a serial one, no more pins J15.D0-D7 , no back-light power supply.
- 2 UART only(2 MIDI In/2Out).
- 2 AIN channels only(e.g. pedal inputs).
- SPI slave only supported by J19(SPI3).

Check the [dipBoardF4](#) for more details 😜

Download

[dipCoreF4 eagle lib](#) for easy integration in your design.

dipcoref4_beta.zip

PCB

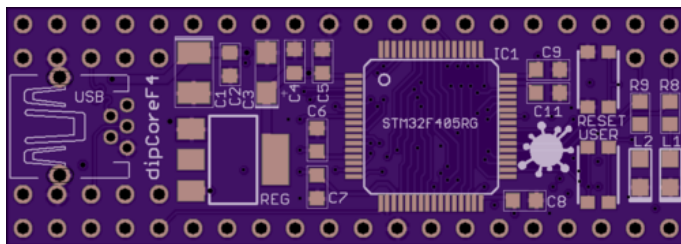

4 layers PCB design.
Fits 4 layer mostly common design rules.

- min. drill 10mil
- min. width 5mil

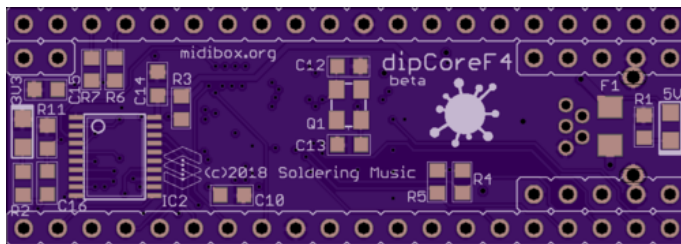

[Top copper](#)

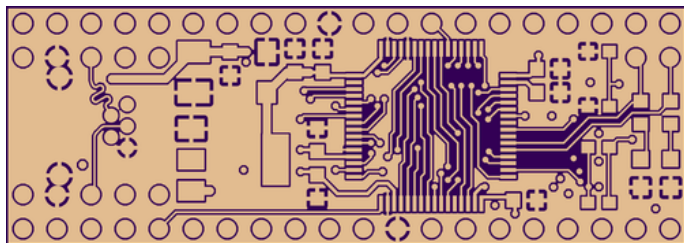

Internal 1

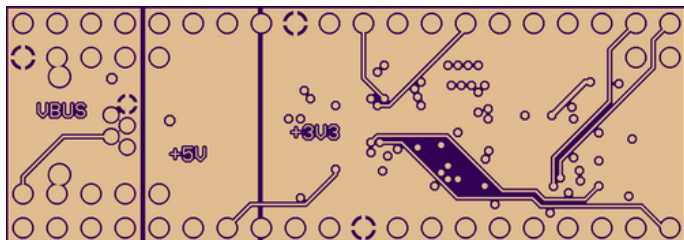

Internal 2

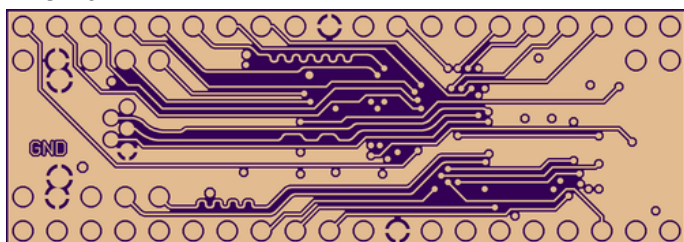

Bottom

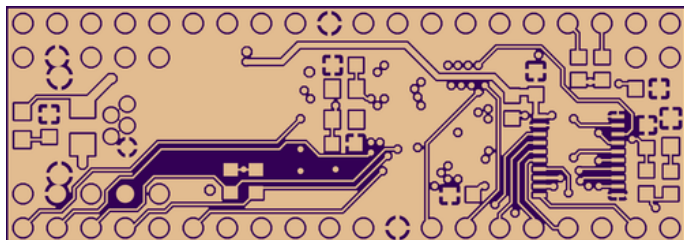

BOM

[Mouser BOM version 1](#) to complete

Qty	Value	Package	Parts	Mouser	Reichelt	Conrad	LCSC	Notes
Resistors								
1	100R 5%	0603	R3	755-ESR03EZPF1000			C253328	
4	680R 5%	0603	R1, R2, R8, R9	667-ERJ-PA3J681V			C103784	Depends on Led
4	10K 5%	0603	R4, R5, R6, R7	755-ESR03EZPJ103			C103199	
1	100K 5%	0603	R11	755-ESR03EZPJ104			C103211	
PTC fuses, resettable thermistors								
1	1206L150THWR	1206	F1	576-1206L150THWR			C261956	
Capacitors								
2	20p	0603	C12, C13	581-06035A200K			C91702	

Qty	Value	Package	Parts	Mouser	Reichelt	Conrad	LCSC	Notes
Resistors								
9	100n	0603	C2, C5, C6, C7, C8, C9, C14, C15, C16	80-C0603C104Z3V			C1688	
3	2,2u	0603	C4, C10, C11	81-GRM188R61E225MA2D			C71001	
1	10u Tantalum	SMC_A(1206)	C3	647-F931C106MAA			C8015	
1	47u Tantalum	SMC_B(1210)	C1	74-TMCMB1C476MTRF			C112105	
Crystal								
1	8MHz	3.2x2.5_KX-7	Q1	oops! Not easy to find :(wait!	will be changed...
LEDs								
4	-	0805	5V, 3V3, L1, L2	755-SML-H12U8TT86C			C72037	
ICs								
1	STM32F405RG	LQFP64	IC1	511-STM32F405RGT6			C15742	
1	74HCT541	TSSOP20	IC2	771-74HCT541PW-T			C131314	
1	LD1117AS33TR	SOT223	REG	511-LD1117AS33			C126055	
Switches								
2	Micro Switches	KMR2 4.6x2.8	RESET, USER	611-KMR221NGLFS			C72443	SMT Tact Switches
Headers								
3	1*20	male		649-68000-420HL			C50981	Termination Post Length max 2.57mm
Connector								
1	mini-USB	THT	USB	571-1734510-1			no!	for other ref take care about restricted area!

Pinout

First, was a chart.

This chart gives you the equivalence between the different pinout and functions.

PIC / MIOS8		STM32F4 / MIOS32								
		dipCoreF4			DISCO / wCore					
DIP-40	MIOS8 Function	DIP-40	LOFP04	STM32 F415RG	MIOS32 Function	LOFP100	STM32F 407VG	Discovery F4 Pin	Pin name	
2	J5 RA0	2	14	GPIO	USER BUTT	23	USER BUTT	P1.12	PA0(5)-WKUP(5)	
3	J5 RA1	3	58	I2C1_SCL	J4B.SC	92	I2C1_SCL	P2.23	PB6	
4	J5 RA2	4	59	I2C1_SDA	J4B.SD	93	USART1_RX	P2.24	PB7	
5	J5 RA3	5	17	USART2_RX	J11.MI1	26	USART2_RX	P1.13	PA3(5)	
6	J5 RA4	6	16	USART2_TX	J11.MO1	25	USART2_TX	P1.14	PA2(5)	
7	J5 RA5	7	15	ADC123_IN1	J5.A0	24	ADC123_IN1	P1.11	PA1(5)	
8	J5 RE0	8	25	ADC12_IN15	J5.A1	34	ADC12_IN15	P1.19	PC5(5)	
9	J5 RE1	9	40	SPI3_RC2(GPIO)	J8/9.RC2	66	LCD-SERVE2	P2.46	PC9	
10	J5 RE2	10	26	SPI2_RC2(GPIO)	J8/9.RC2	35	ADC12_IN8	P1.22	PB0(5)	
13	OSC1	13	46	JTMS-SWDIO		72	JTMS-SWDIO	P2.42	PA13	
14	OSC2	14	49	JTCK-SWCLK		76	JTCK-SWCLK	P2.39	PA14	
15	J6/7_RC	15	50	SPI3_RC1(NSS)	J9.RC1	77	SPI3_NSS:RC1	P2.40	PA15	
16	J6/7_SC	16	55	SPI3_SCK	J9.SC	89	SPI3_SCK	P2.28	PB3	
17	J6/7_SO	17	57	SPI3_MOSI	J9.SO	91	SPI3_MOSI	P2.26	PB5	
18	J6/7_SI	18	56	SPI3_MISO	J9.SI	90	SPI3_MISO	P2.25	PB4	
19	J8/9_S0	19	11	SPI2_MOSI	J8/9.SO	18	N.U.	P1.9	PC3(5)	
20	J8/9_S1	20	10	SPI2_MISO	J8/9.SI	17	ADC123_IN12	P1.10	PC2(5)	
21	J8/9_RC	21	27	SPI2_RC1(GPIO)	J8/9.RC1	36	ADC12_IN9	P1.21	PB1(5)	
22	J8/9_SC	J10_SC	22	34	SPI2_SCK	J8/9.SC	52	SPI2_SCK	P1.37	PB13
23	J10_RC	23	30	I2C2_SDA	J4A.SC	48	I2C2_SDA	P1.35	PB11	
24	J10_SO	24	29	I2C2_SCL	J4A.SD	47	I2C2_SCL	P1.34	PB10	
25	J11_TX	25	51	UART4_TX	J11.MO2	78	DAC_CK(discovery)	P2.37	PC10	
26	J11_RX	26	52	UART4_RX	J11.MI2	79	LCD-SERVE/RV	P2.38	PC11	
27	J14	27	8	GPIO	J15.CS2	15	OTG_FS_EN	P1.8	PC0(5)	
28	J15_RS	J10_MD	28	54	GPIO	J15.DC	83	UART5_RX	P2.34	PD2
29	J15_RW	J10_MO	29	53	GPIO	J15.SDA	80	UART5_TX	P2.35	PC12
30	J15_E	30	9	GPIO	J15.SCL	16	ADC123_IN11	P1.7	PC1(5)	
33	J15_D0	33	33	GPIO	J15.CS1	51	SPI2_NSS:RC1	P1.36	PB12	
34	J15_D1	34	24	SPI1_RC2(GPIO)	J16.RC2	33	ADC12_IN14	P1.20	PC4(5)	
35	J15_D2	35	62	CAN1_TX	J18.TX	96	I2C1_SDA	P2.20	PB9	
36	J15_D3	36	61	CAN1_RX	J18.RX	95	SPI3_RC2	P2.19	PB8	
37	J15_D4	37	20	SPI1_RC1(NSS)	J16.RC1	29	ADC12_IN4	P1.16	PA4(5)	
38	J15_D5	38	21	SPI1_SCK	J16.SC	30	SPI1_SCK	P1.15	PA5(5)	
39	J15_D6	39	22	SPI1_MISO	J16.SI	32	SPI1_MOSI	P1.17	PA7(5)	
40	J15_D7	40	23	SPI1_MOSI	J16.SO	31	SPI1_MISO	P1.18	PA6(5)	
		41	43	OTG_FS_ID	J1.D1	69	OTG_FS_ID	P2.41	PA10	
		42	45	OTG_FS_DP	J1.DP1	71	OTG_FS_DP	CN5 (USB)	PA12	
		44	35	OTG_HS_DM	J1.DM2	53	SPI2_MISO	P1.38	PB14	
		45	36	OTG_HS_DP	J1.DP2	54	SPI2_MOSI	P1.39	PB15	
		46	42	OTG_FS_VBUS	J1.VBUS	68	OTG_FS_VBUS	P2.44	PA9	
		48	44	OTG_FS_DM	J1.DM1	70	OTG_FS_DM	CN5 (USB)	PA11	
		49	3	OTG_HS_OC	J1.OC2	8	J10/D9	P2.9	PC14(3)-OSC32_IN(5)	
		50	4	OTG_HS_EN	J1.EN2	9	J10/D10	P2.10	PC15(3)-OSC32_OUT(5)	
		51	38	LED BLUE	LED.2	64	DAC_MCK(discovery)	P2.48	PC7	
		52	37	LED RED	LED.1	63	USART6_TX	P2.47	PC6	
			2	N.U.		7	J10/D8	P2.12	PC13(3)	
			5	OSC_IN		12	N.U.	P2.7	PH0(5)-OSC_IN	
			6	OSC_OUT		13	N.U.	P2.8	PH1(5)-OSC_OUT	
			28	N.U.		37	SPI1_RC1	P1.24	PB2	
			39	N.U.		65	LCD-SERVE1	P2.45	PC8	
			41	N.U.		67	LCD-RS	P2.43	PA8	



xls chart

The dipCoreF4 and the legacy MIOS32 ports.

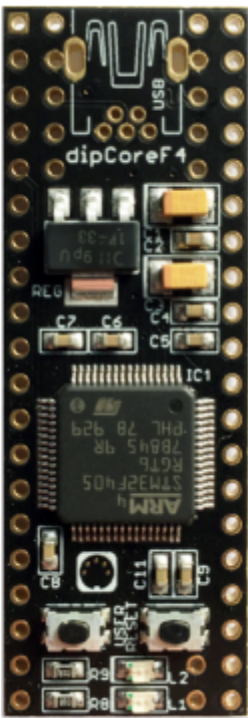
1	RESET	41	J1.ID1		VBUS/5V(IN)	46	J16.SO	40
2	USER-BUTTON	42	GND		GND	46	J16.SI	39
3	J4.SC1	43	J1.DP1		J1.DM1	48	J16.SC	38
4	J4.SD1	44	J1.DM2		J1.OV2	49	J16.RC1	37
5	J11.MI1	45	J1.DP2		J1.EN2	50	J18.RX	36
6	J11.MO1						J18.TX	35
7	J5.A0						J16.RC2	34
8	J5.A1						J15.CS1	33
9	J19.RC2						VBAT/3V3(OUT)	32
10	J8/9.RC2						GND	31
11	3V3(OUT)						J15.SCL	30
12	GND						J15.SDA	29
13	SWDIO						J15.DC	28
14	SWCLK						J15.CS2	27
15	J19.RC1						J11.MI2	26
16	J19.SC						J11.MO2	25
17	J19.SO						J4.SD2	24
18	J19.SI						J4.SC2	23
19	J8/9.SO						J8/9.SC	22
20	J8/9.SI						J8/9.RC1	21
				LED.2	51			
				LED.1	52			

Check [dipBoardF4](#) for more details about the connectors.

407VG vs 405RG

Legacy STM32F407 and 405 share the same characteristics.

The 405RG is a TQFP64, a 10x10mm package and only 64 pins.

No Ethernet MAC and camera interface.

Compare Attributes ✕		
<input checked="" type="checkbox"/> Show Differences	STM32F405RG ✕	STM32F407VG ✕
Description	High-performance foundation line, ARM Cortex-M4 core with DSP and FPU, 1 Mbyte Flash, 168 MHz CPU, ART Accelerator	High-performance foundation line, ARM Cortex-M4 core with DSP and FPU, 1 Mbyte Flash, 168 MHz CPU, ART Accelerator, Ethernet, FSMC
Package	LQFP 64 10x10x1.4	LQFP 100 14x14x1.4
Core	Arm Cortex-M4	Arm Cortex-M4
Operating Frequency (MHz) (Processor speed)	168	168
Co-Processor type	-	-
Co-Processor frequency (MHz) (max)	-	-
FLASH Size (kB) (Prog)	1024	1024
Data E2PROM (B) (nom)	-	-
RAM Size (kB)	192	192
Timers (typ) (16 bit)	12	12
Timers (typ) (32 bit)	2	2
Other timer functions	2 x WDG, 24-bit down counter, RTC	2 x WDG, 24-bit down counter, RTC
A/D Converters (12-bit channels)	16	16
A/D Converters (16-bit channels)	-	-
D/A Converters (typ) (12 bit)	2	2
Comparator	-	-
IODs (High Current)	51	82
Display controller	-	-
CAN (typ)	2	2
CAN FD (typ)	-	-
I2C (typ)	3	3
SPI (typ)	3	3
I2S (typ)	2	2
USB Type	USB OTG FS + USB OTG FS/HS	USB OTG FS + USB OTG FS/HS
USART (typ)	4	4
UART (typ)	2	2
Connectivity supported	-	-
Integrated op-amps	-	-
Additional Serial Interfaces	-	Ethernet
Parallel interfaces	FSMC, SD/MMC	FSMC, SD/MMC
Crypto-HASH	-	-
TRNG (typ)	true	true
SMPs	-	-
Supply Voltage (V) (min)	1.8	1.8
Supply Voltage (V) (max)	3.6	3.6
Supply Current (µA) (typ) (Lowest power mode)	1.7	1.7
Supply Current (µA) (typ) (Run mode (per Mhz))	215	215
Operating Temperature (°C) (min)	-40	-40
Operating Temperature (°C) (max)	105	105
A/D Converters (typ)	-	-
Number of Channels (typ)	-	-
A/D Converters (typ)	-	-
Number of Channels (typ)	-	-

ST STM32F4xx series

In MIOS32

We use the same peripheral drivers same family, some compilation defined conditions were added for the specific pinout and type, number of ports. [ToDo](#)

From:

<https://wiki.midibox.org/> - **MIDIbox**

Permanent link:

<https://wiki.midibox.org/doku.php?id=dipcoref4&rev=1585675560>

Last update: **2020/03/31 17:26**

