

# DinX2DoutX1

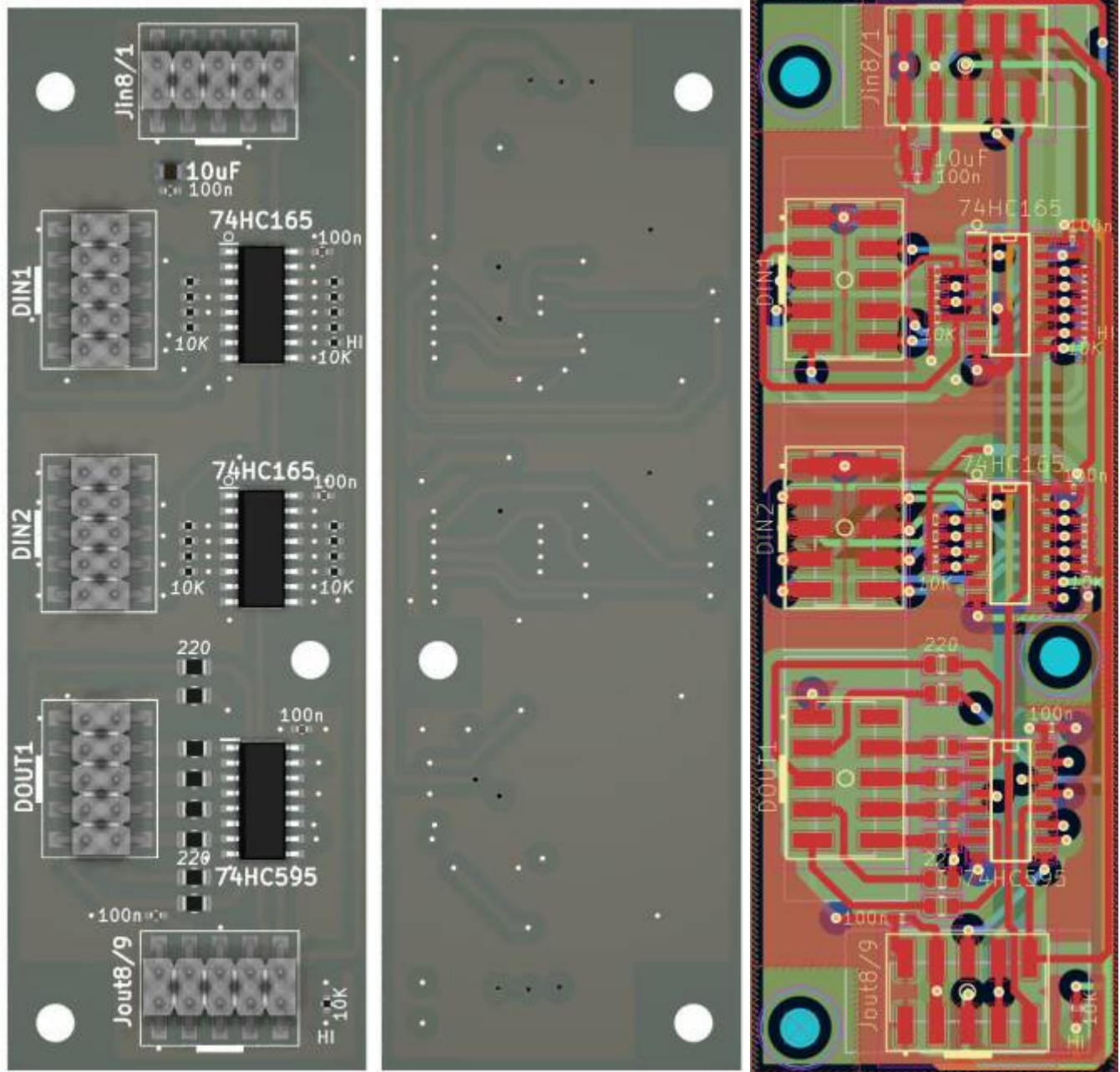

## it gives;

16 Digital Inputs

8 Digital Outputs

The Board is fully SMD, and made for pick and place - so no soldering required!

## Schematic

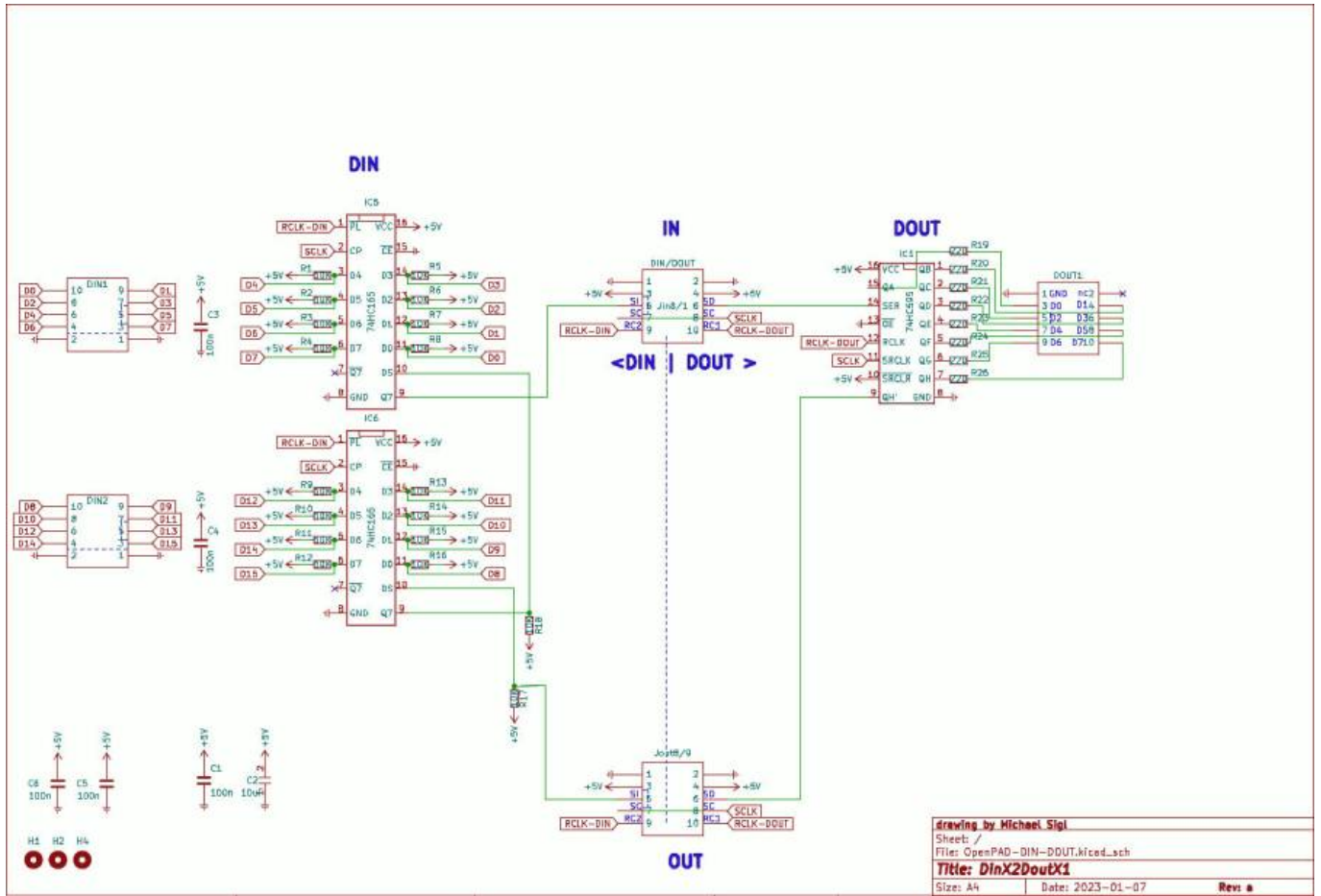

# Building and BOM

Its build by pick and place robots... so no need to build, or order any component you need this PCB 1x for [OpenPAD](#)

## BOM

Follwing list is for reference, and debugging only, **no need to order them!** all the parts are already soldered on the PCB!

qty	reference	value	jlc	
5	C1, C3, C4, C5, C6	100n	C307331	81-GRM155R61E104KA7J
1	C2	10uF	C440198	81-GRM21BR61H106KE3K
2	DIN1,DIN2	Gates	C124391	649-1012938391001ALF
3	DOUT1, Jin8/1, Jout8/9	DIN/DOUT	C124391	649-1012938391001ALF
1	IC1	74HC595	C5947	595-SN74HC595DR
2	IC5, IC6	74HC165	C5613	595-SN74HC165DRG3
18	R1-R18	10K	C25744	303-0402WGF1002TCE
8	R19-R26	220	C25294	

# To Do

waiting for the assembled Prototype

## Community users working on it

- **Phatline** = PCB & Schematic, UI-Programming, Documentation...

Just let a Private message on the forum to user already involved.

or join the forum: [Triggermatrix 5](#)

From:

<https://wiki.midibox.org/> - **MIDIbox**

Permanent link:

<https://wiki.midibox.org/doku.php?id=doutx2dinx1&rev=1673226703>

Last update: **2023/01/09 01:11**

