

EASY CV

Test Equipment: CV-Destination MB33 MAM:



Introduction

All Parameters are saved as a preset as a song (programchange...)

Digital created LFO+ENV with CV-Output.

No Displays, No Menues, Minimal buttons, much Scopes, much Led-Ring-Rotarys (LRE-8x2CS)
one big UI with complete functions for one LFO+ENV Voice + 4xChannelstrip Controlls...

LFO+ENV are mixed together softwareside, to use only one CV-Output

Each Channel = Filter need 8xCV-Outputs

Copy Paste for LFOs and ENvelopes between the Voices

Copy Paste for a Song aka Preset aka Bank aka Program(change)

Jam Style Pattern load (next Preset Display) + Preset Morph between Current-Preset and Next-Preset

The Early Design was a EuroRack-Module: A Breakoutmodule for each CV-Output, with Depth-rotary, Focusswitch (Pushrotary), 2x Scopes (LFO+ENV) and LFO/ENV-Switch to show on one Display the Mixed Waveform & to switch the Rotary to "ENV" or "LFO" Mode (there is only space for one Encoder - maybe just make PAN Style, instead of 2 individual level -maybe more live feel?, how ever when using an 3Stage switch, i could disable MIX-View, or display it on ENV or LFO...maybe a good choise ;)) The Depth-rotary has no Ledring, want to display it as a bar or as Value in the scope...

FrontPanel

Brain

THE LEFT SIDE of the BRAIN > Preset-Management: **Save & Load** the PROGRAM, can be done by Midi-ProgramChange -or With the **LOAD-PRESET**-Encoder then press **LOAD** -or **Morph** to the next Program slowly with the MORPH-Encoder
 -Another option is to take a **PUSH-ENCODER** for **LOAD & STORE** > and load and store it by pushing it... would free 2 buttons for other functions.

MORPH?:

-The Upper 7 Segment LED- Display: is the **LOAD Display** indicate the new Program with ENV+LFO -
 The downer 7 Segment LED- Display: is the **STORE Display** it indicates also the current Program with ENV+LFO

-with morph you crossfade between both Presets (be carefull, first Store the current Preset

Paste & Copy do their job @ the whole PROGRAM Memory

ENV-PASTE & ENV-COPY do their job @ the selected Envelope > (ENV-Voice selection is done by the breakout Modules) ... LFO..same

Midi-Channel Note NR or Number of Envelope is a real programmer job (C), with usb-upload from computer this is a individual device, and once set, it has to play > and it just should do LFOs and Envelopes Fixed routed, no generic, special > in my case for a filterbank.

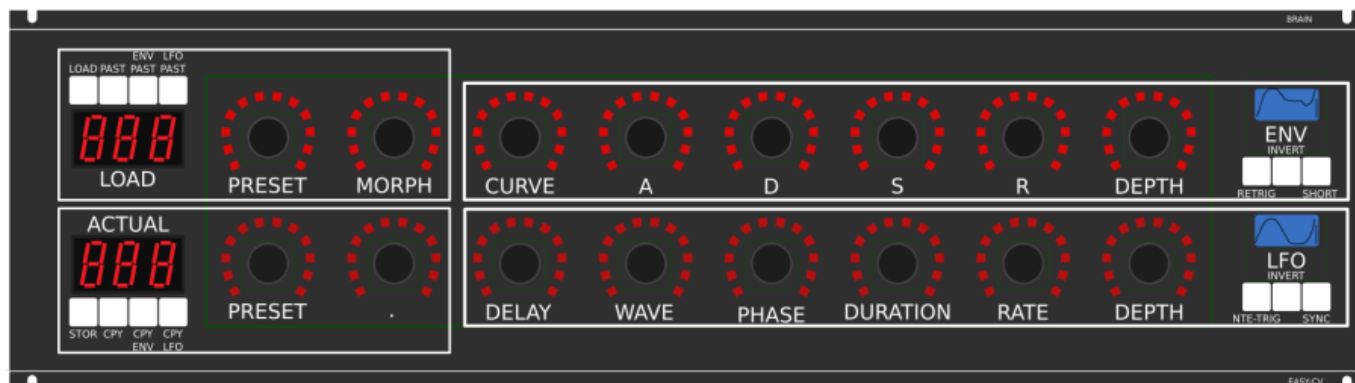

THE RIGHT SIDE of the BRAIN > LFO + ENV Settings (one Voice): ADSR with:

CURVE Parameter which give exponentially to it (no straight lines While Fall and Rise)

Short: just shorten the Maximal length of a Envelope, having more Feeling on Encoders should change Scope Display also...

LFO: get synced with Midi, and there is a retrigger by Notes...

Phase: offsets the start-Phase

Delay: simple delay (nte-Trig)

Rate: clear from 8 wholes to 128th or so

Wave: access to the Waveforms

Duration: interpret Midisync in trippled, whole notes or whatever...

DEPTH: is the maximal Value of FALL and RISE and SUSTAIN, i know i loose resolution with this...but i have to have a memory filterbank,...doing depth instead with Potentiometers on Filtermodules... would give no memory...

BreakOut

this will not be supportet > since i dont want a Euro-Module Setup > i want one big filterbox.

1. Discharged UserInterface for the Brain in "Island mode" (Scopes + Digital-CV-Amount)

2. CV-Breakout EuroModule to be located near the CV-Destination (example: a Filter).

2 Waveforms (ENV+LFO) are mixed together softwareside

that bring 2 advantageges:

1. save one CV-Output

2. the Amplitude of each Waveform is saved in the patch, so the CV-Amount to a Filter is saved in the Patch

That bring 2 disadvantageges:

1. LFO or ENV cant get patched to individual destination

2. the Resulation gets lower 2 very low, and the code has to be adptet much... or have to be made from scratch Because I use the device for a Memory-Filterbox (VCF+VCA), i am ok with the pros and cons, so i call it EASY-CV



Envelope Scope: show the ENV-Waveform
or the Mixed-CV-Output-Waveform (when Switch is in LFO Mode)
and show the Envelope-Amount with a BAR or as numeric Value?

MIXED CV Plug: CV-Output > Mixed Waveform ENV+LFO

Switch @ ENV:

1. Depth-Encoder change ENV Amount of the CV-MIX
2. ENV Scope will show ENV Wave
3. LFO Scope will Show CV-Mix

Switch @ LFO: visa versa ENV

Press the Encoders built in **ENCODER-BUTTON:**

will switch the BRAIN-A-D-S-R and L-F-O ENCODER to the Page for THIS Module...

workflow, see what you have with a Scope, over a filter, and edit exact this selected CV on the brain in full detail...

VCA-VCF

CVs(AOUT):

- 1.VCF-CUT
- 2.VCF-RES
- 3.FILTER DRIVE
- 4.VCA-ENV
- 5.VCA-DRIVE
- 6.DRY-WET (Original vs Filtered Mixer)
- 7.Send 2 EFX1
- 8.Send 2 EFX2

So 1x 8AOUT-Module for each "Channelstrip", makes a total of 4x8AOUT-Modules. The Module of Choise is a 16Bit, since i control with the the same AOUT-Channel ENV+CUT-OFF... so there is no analog potentiometer for Cutoff or resonance... it is all saved in the Preset.

the VCA is basicly a simple VCA (MS20Like) or something
the VCF are a 303 18dB for the 24db Filter it will be a SSM2044, where boards are available.

Original Schematics 303 - VCA-VCF

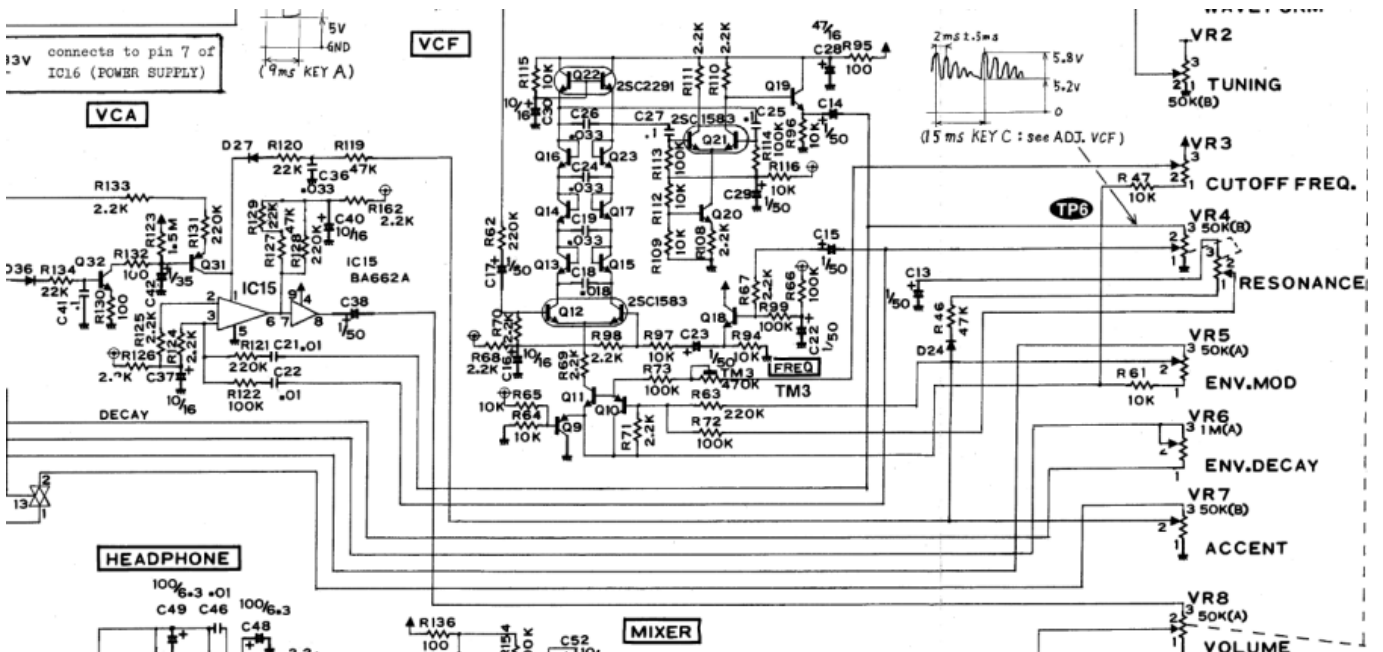

In order to not use those **overprized MATCHED-PAIR-TRANSISTORS** (over 2€ on the cheapest place) i have to use standart Transistors and make a **VBE-MATCH** on my own, i have already a PCB from here - to measure the transistors with a Multimeter: <https://midisizer.com/other/vbe-matching/>

Example for a Filterbank

EUROMODULE-BASED >> It is not planed to do it that way (just for you to get some input)

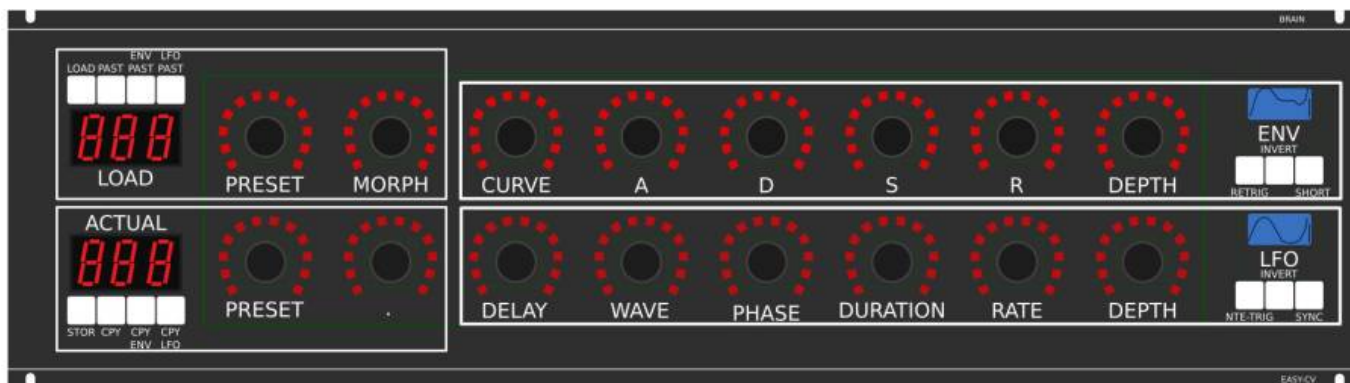

THE BRAIN - LEFT SIDE
 Preset-Management:
 Save and Load the "SONG" or call it "BANK"
 The Song is loaded by ProgramChange
 OR
 With the LOAD-PRESET-Encoder
 BUT it will not be heard
 you must first press-LOAD
 or Morph to it slowly with MORPH-Encoder
 MORPH:
 You have the NEW-ENV+LFO @ LOAD
 You have the current ENV+LFO @ ACTUAL
 with morph you crossfade between both

Paste, and Copy do their job @ the full BANK
 ENV-PASTE-ENV-COPY do their job @ the selected Envelope
 (selection is done by the breakout-Modules)

Midi-Channel Note NR or Number of Envelope is
 a real programmer job, with usb-upload-from-computer

 this is a individual device, and once set, it has to play
 and it just should do LFOs and Envelopes
 fixed routed, no generic, special
 in my case for a filterbank.

MPE-CV/Brain & UI-MAIN (Scopes + Digital-CV-Amount)
 send near the CV-Destination (e.g. a Filter)
 together software-side

is saved in the patch, so the CV-Amount to a Filter is saved in the Patch

dividual destination
 iw, and the code has to be adaptet much... or have to be made from scratch
 ry-Filterbox (VCF+VCA), I am ok with the pros-and-cons, so I call it Simple-CV

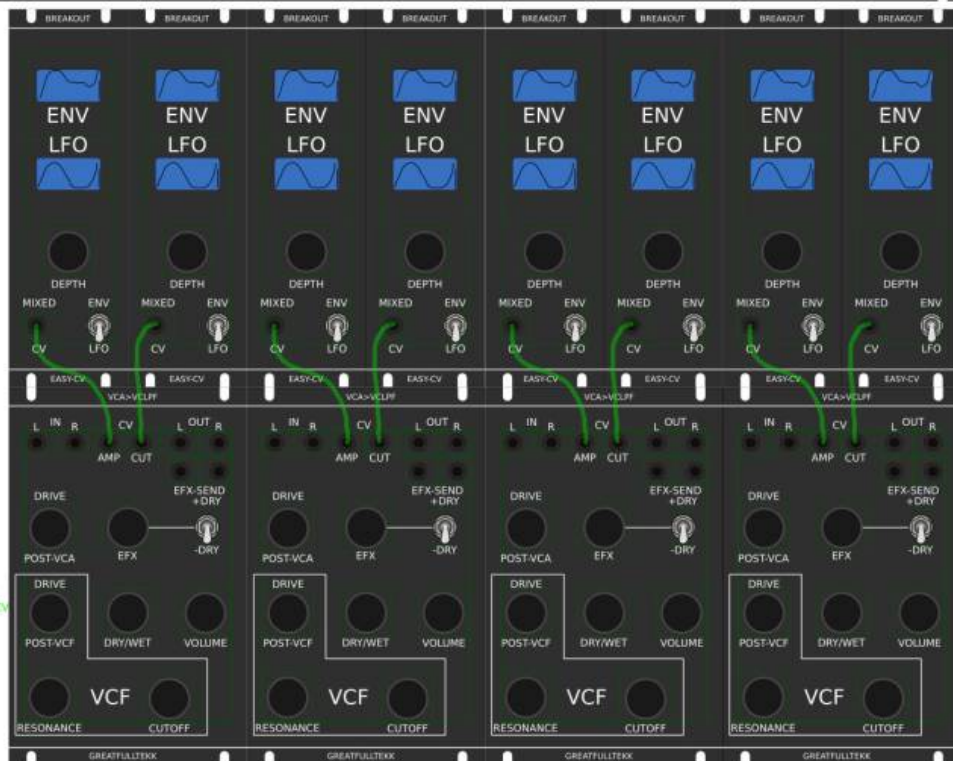

A not EUROMODULE-BASED Version of something like this is the FILTERBOX:
 (this is the Design I prefer @ the moment)

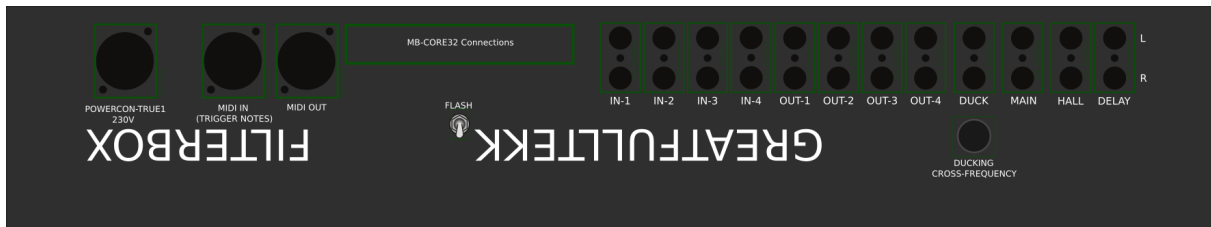

BACK-PANEL

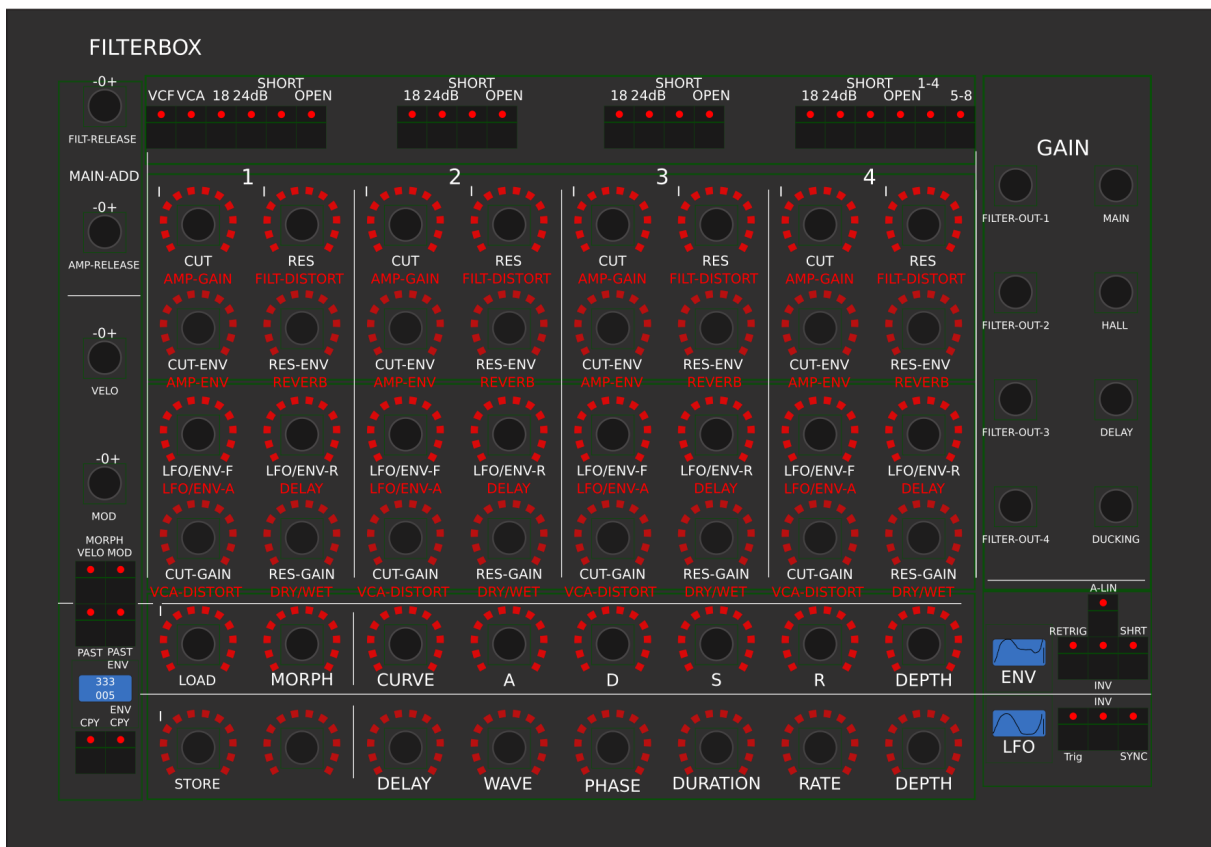

FRONT-PANEL

General Design

The Panel is made of transparent but shaded (black transparent) Plexiglass.

The Panel is directly mounted into a Flightcase.

The 3x LRE8x2 (LED RING) are mounted with the Encoder Nuts, the rest of the PCBs are mounted with normal thru-hole screws.

FrontPanel

PCBs

The Analog-IO Board on the Backpanel, holds:

- the ENV-VCAs
- the DryWet-VCAs, Filter-Relay-Switch
- SEND-EFX-VCAs
- the Summing Mixer
- the Ducking-Cross-AMP-Follower+Ducking-VCAs
- VCF+ENV-VCA-Distortion-Driver-VCAs

-the Connectors to connect the Filter, AOOUT, Poti-Boards

Left-Part of the Brain on Breathboard:

OLED-Display

Button: ShadowSE/ITT

ENCODER: with built in Pushswitch

a early state with 7Segment Displays to indicate the Patches

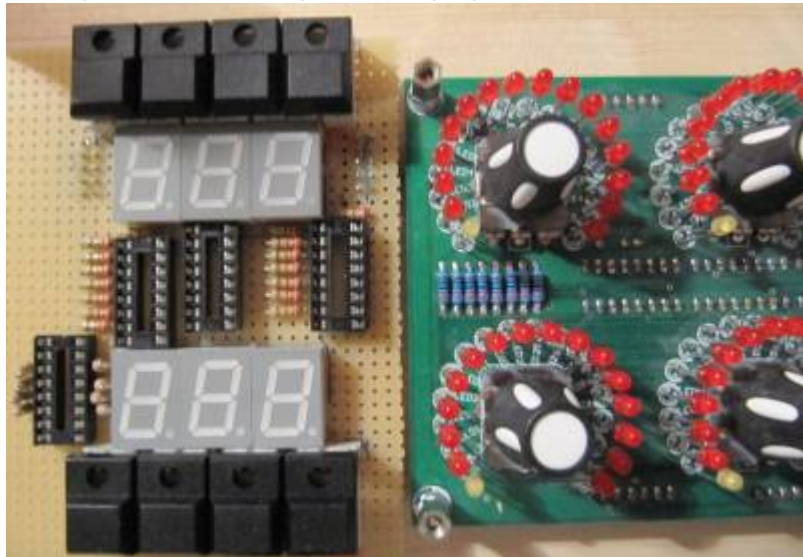

1. UI Parts Listing

BRAIN + BREAKOUT

- 6,3 Neutrik Connector
- [FLASH-Switch @ Rs-components](#)

Value	Type	Qty
Switch	SPDT Vertical PCB-Mount ON-OFF-ON	1

Fix Me! Fill Table

Pots / Knobs

- [Alps RK11K Series](#)
- [Alpha Pots @ Thonk](#)
- [Knobs Suppliers](#)

- **Fix Me!** which Values for the Audio-Mixer?

3.Footprint Making in KiCAD

- ALPS Pots
- Alpha Pots

- 6,3mm Jack
- Switch
- Momentary Switch
- SSD-Displays
- OLED Display
- Rotary Encoder



have to be done

4. Schematics in KiCAD



have to be done

5.PCB Making In Kicad

PCB Making Order

- BRAIN PCBs:
 - a.Left-Brain
 - b.Right-Brain
- 3x LRE8x2CS - is a generic PCB which i already have (fairlightiiís)
- Backpanel PCB
- FILTER PCBs

From:
<https://wiki.midibox.org/> - **MIDIbox**

Permanent link:
https://wiki.midibox.org/doku.php?id=easy_cv&rev=1471135148

Last update: **2016/08/14 00:39**

