

About

A DIN module is used to connect buttons and encoders to the Midibox. The Name comes from “Digital Input” and means that the module can detect two states: ON or OFF. It then sends this information to be processed by the [mbhp core module](#). It comes with multiple serial registers 74HC165; every register provides 8 digital inputs, which are sampled with the latch enable signal LD and shifted out with the clock signal CLK. The advantage of using such shift registers is, that they can be cascaded to a long chain without the need of more than 5 cables to the core module. The DIN board has been designed on a way which allows to cascade not only the ICs on the board, but also several DIN modules. But note that it depends on the firmware how much inputs are processed by the core module. For instance, the MIDIbox64 allows to connect up to 64 buttons = 8 ICs = 2 * DINX4, the MIDI0128 supports 128 inputs = 16 ICs = 4 DINX4 modules.

Getting Started

- [Preparation](#)
- [soldering](#)
- [Wher to buy Parts](#)
- [etching_pcb](#)
- [terminating_cables](#)

Special Instructions

- [smd_soldering](#)
- etc

Details

Pins

DIN & DOUT pin-numbers

The following table shows the relation between pin- and serial-register-numbers on the software side, and physical pins and their labeling on the hardware side. Shiftregisters are always counted from 1 (also on the software-side), and pins are always counted from 0.

Please note that the order of DOUT pins is reversed compared to DIN pins. For a deeper explanation of this issue, refer the information after the table.

Pin table

Shift Register	SR number	Pin Number (sw)	Pin Hex number (sw)	Pin Name (DIN PCB / SR IC)	Pin Name (DOUT PCB / SR IC)
first	1	0	0x00	D0 / QA	D7 / H
first	1	1	0x00	D1 / QB	D6 / G
first	1	2	0x00	D2 / QC	D5 / F
first	1	3	0x00	D3 / QD	D4 / E
first	1	4	0x00	D4 / QE	D3 / D
first	1	5	0x00	D5 / QF	D2 / C
first	1	6	0x00	D6 / QG	D1 / B
first	1	7	0x00	D7 / QH	D0 / A
second	2	8	0x0 8	D0 / QA	D7 / H
second	2	9	0x0 9	D1 / QB	D6 / G
second	2	10	0x0a	D2 / QC	D5 / F
second	2	11	0x0b	D3 / QD	D4 / E
second	2	12	0x0c	D4 / QE	D3 / D
second	2	13	0x0d	D5 / QF	D2 / C
second	2	14	0x0e	D6 / QG	D1 / B
second	2	15	0x0f	D7 / QH	D0 / A
third	3	16	0x10	D0 / QA	D7 / H
third	3	17	0x11	D1 / QB	D6 / G
third	3	18	0x12	D2 / QC	D5 / F
third	3	19	0x13	D3 / QD	D4 / E
third	3	20	0x14	D4 / QE	D3 / D
third	3	21	0x15	D5 / QF	D2 / C
third	3	22	0x16	D6 / QG	D1 / B
third	3	23	0x17	D7 / QH	D0 / A
fourth	4	24	0x18	D0 / QA	D7 / H
fourth	4	25	0x19	D1 / QB	D6 / G
fourth	4	26	0x1a	D2 / QC	D5 / F
fourth	4	27	0x1b	D3 / QD	D4 / E
fourth	4	28	0x1c	D4 / QE	D3 / D
fourth	4	29	0x1d	D5 / QF	D2 / C
fourth	4	30	0x1e	D6 / QG	D1 / B
fourth	4	31	0x1f	D7 / QH	D0 / A
fifth	5	32	0x20	D0 / QA	D7 / H
fifth	5	33	0x21	D1 / QB	D6 / G
fifth	5	34	0x22	D2 / QC	D5 / F
fifth	5	35	0x23	D3 / QD	D4 / E
fifth	5	36	0x24	D4 / QE	D3 / D
fifth	5	37	0x25	D5 / QF	D2 / C
fifth	5	38	0x26	D6 / QG	D1 / B
fifth	5	39	0x27	D7 / QH	D0 / A
sixth	6	40	0x2 8	D0 / QA	D7 / H
sixth	6	41	0x2 9	D1 / QB	D6 / G
sixth	6	42	0x2a	D2 / QC	D5 / F

Shift Register	SR number	Pin Number (sw)	Pin Hex number (sw)	Pin Name (DIN PCB / SR IC)	Pin Name (DOUT PCB / SR IC)
sixth	6	43	0x2b	D3 / QD	D4 / E
sixth	6	44	0x2c	D4 / QE	D3 / D
sixth	6	45	0x2d	D5 / QF	D2 / C
sixth	6	46	0x2e	D6 / QG	D1 / B
sixth	6	47	0x2f	D7 / QH	D0 / A
seventh	7	48	0x30	D0 / QA	D7 / H
seventh	7	49	0x31	D1 / QB	D6 / G
seventh	7	50	0x32	D2 / QC	D5 / F
seventh	7	51	0x33	D3 / QD	D4 / E
seventh	7	52	0x34	D4 / QE	D3 / D
seventh	7	53	0x35	D5 / QF	D2 / C
seventh	7	54	0x36	D6 / QG	D1 / B
seventh	7	55	0x37	D7 / QH	D0 / A
eighth	8	56	0x3 8	D0 / QA	D7 / H
eighth	8	57	0x3 9	D1 / QB	D6 / G
eighth	8	58	0x3a	D2 / QC	D5 / F
eighth	8	59	0x3b	D3 / QD	D4 / E
eighth	8	60	0x3c	D4 / QE	D3 / D
eighth	8	61	0x3d	D5 / QF	D2 / C
eighth	8	62	0x3e	D6 / QG	D1 / B
eighth	8	63	0x3f	D7 / QH	D0 / A
ninth	9	64	0x40	D0 / QA	D7 / H
ninth	9	65	0x41	D1 / QB	D6 / G
ninth	9	66	0x42	D2 / QC	D5 / F
ninth	9	67	0x43	D3 / QD	D4 / E
ninth	9	68	0x44	D4 / QE	D3 / D
ninth	9	69	0x45	D5 / QF	D2 / C
ninth	9	70	0x46	D6 / QG	D1 / B
ninth	9	71	0x47	D7 / QH	D0 / A
tenth	10	72	0x4 8	D0 / QA	D7 / H
tenth	10	73	0x4 9	D1 / QB	D6 / G
tenth	10	74	0x4a	D2 / QC	D5 / F
tenth	10	75	0x4b	D3 / QD	D4 / E
tenth	10	76	0x4c	D4 / QE	D3 / D
tenth	10	77	0x4d	D5 / QF	D2 / C
tenth	10	78	0x4e	D6 / QG	D1 / B
tenth	10	79	0x4f	D7 / QH	D0 / A
eleventh	11	80	0x50	D0 / QA	D7 / H
eleventh	11	81	0x51	D1 / QB	D6 / G
eleventh	11	82	0x52	D2 / QC	D5 / F
eleventh	11	83	0x53	D3 / QD	D4 / E
eleventh	11	84	0x54	D4 / QE	D3 / D
eleventh	11	85	0x55	D5 / QF	D2 / C

Shift Register	SR number	Pin Number (sw)	Pin Hex number (sw)	Pin Name (DIN PCB / SR IC)	Pin Name (DOUT PCB / SR IC)
eleventh	11	86	0x56	D6 / QG	D1 / B
eleventh	11	87	0x57	D7 / QH	D0 / A
twelfth	12	88	0x5 8	D0 / QA	D7 / H
twelfth	12	89	0x5 9	D1 / QB	D6 / G
twelfth	12	90	0x5a	D2 / QC	D5 / F
twelfth	12	91	0x5b	D3 / QD	D4 / E
twelfth	12	92	0x5c	D4 / QE	D3 / D
twelfth	12	93	0x5d	D5 / QF	D2 / C
twelfth	12	94	0x5e	D6 / QG	D1 / B
twelfth	12	95	0x5f	D7 / QH	D0 / A
thirteenth	13	96	0x60	D0 / QA	D7 / H
thirteenth	13	97	0x61	D1 / QB	D6 / G
thirteenth	13	98	0x62	D2 / QC	D5 / F
thirteenth	13	99	0x63	D3 / QD	D4 / E
thirteenth	13	100	0x64	D4 / QE	D3 / D
thirteenth	13	101	0x65	D5 / QF	D2 / C
thirteenth	13	102	0x66	D6 / QG	D1 / B
thirteenth	13	103	0x67	D7 / QH	D0 / A
fourteenth	14	104	0x6 8	D0 / QA	D7 / H
fourteenth	14	105	0x6 9	D1 / QB	D6 / G
fourteenth	14	106	0x6a	D2 / QC	D5 / F
fourteenth	14	107	0x6b	D3 / QD	D4 / E
fourteenth	14	108	0x6c	D4 / QE	D3 / D
fourteenth	14	109	0x6d	D5 / QF	D2 / C
fourteenth	14	110	0x6e	D6 / QG	D1 / B
fourteenth	14	111	0x6f	D7 / QH	D0 / A
fifteenth	15	112	0x70	D0 / QA	D7 / H
fifteenth	15	113	0x71	D1 / QB	D6 / G
fifteenth	15	114	0x72	D2 / QC	D5 / F
fifteenth	15	115	0x73	D3 / QD	D4 / E
fifteenth	15	116	0x74	D4 / QE	D3 / D
fifteenth	15	117	0x75	D5 / QF	D2 / C
fifteenth	15	118	0x76	D6 / QG	D1 / B
fifteenth	15	119	0x77	D7 / QH	D0 / A
sixteenth	16	120	0x7 8	D0 / QA	D7 / H
sixteenth	16	121	0x7 9	D1 / QB	D6 / G
sixteenth	16	122	0x7a	D2 / QC	D5 / F
sixteenth	16	123	0x7b	D3 / QD	D4 / E
sixteenth	16	124	0x7c	D4 / QE	D3 / D
sixteenth	16	125	0x7d	D5 / QF	D2 / C
sixteenth	16	126	0x7e	D6 / QG	D1 / B
sixteenth	16	127	0x7f	D7 / QH	D0 / A

Numbers, labels and order of pins

Also refer this forum article: <http://www.midibox.org/forum/index.php/topic,12379.0.html>

Pin and SR order

For DOUT shift registers, software pin-numbers will be reflected in reverse direction on hardware level:

pin-number 0 (software level) is D7 of the first shift register (hardware level), not D0!

pin-number 15 (software level) is D0 of the second shift register(hardware level), not D7!

The first shift register is for both DIN and DOUT the one that is closest to the core on hardware level.

Labeling

In the datasheets of the shift-register IC's, D0 is often labled A / QA, D7 is labled H / QH.

In TK's layouts the labels for IC-pins are I0 - I7, O0 - O7, which corresponds to A/QA - H/QH.

DIN chain

hardware-level: CORE ← R1::qH ← R1::H ← R1 ← R1::G R2::qH ← R2::H etc.

The first bit read is DIN1::I7, this goes to the MSB on software level. MSB represents the higher pin value,

so you have the same order in hard- as in software.

DOUT chain

hardware-level: CORE → R1::SER → R1::A → R1::B → R1::C R2::SER → R2::A etc.

first bit pushed out is LSB of the last SR(software level), this goes to Rlast::H. Last bit pushed out is MSB of first SR (software level), this goes to R1:A. On software level, MSB represents the higher pin value, so A will represent alway the higher pin value on hw-level for DOUT chains.

Bit order

MIOS_DOUT_SRSet / MIOS_DOUT_SRGet / MIOS_DIN_SRSet / MIOS_DIN_SRGet: LSB always reflects the lowest pin number, MSB the highest pin number.

Pin mappings in software (assembler)

Sometimes the pin numbers of special DINs or DOUTs can be specified in the main.asm or setup_*.asm file of a MIOS application.



this should go in the application's user manual.

Examples

```
#define DEFAULT_MIDI_RX_LED 0x40 ; DOUT SR#9, pin D0
#define DEFAULT_MIDI_TX_LED 0x41 ; DOUT SR#9, pin D1
```

```
#define DEFAULT_DIN_MENU_EXEC 7 ; menu exec button assigned to
DIN pin #7
#define DEFAULT_DIN_MENU_SNAPSHOT 6 ; menu snapshot button
assigned to DIN pin #4
#define DEFAULT_DIN_MENU_RIGHT 5 ; NOT USED - overlaid by
datawheel
#define DEFAULT_DIN_MENU_LEFT 4 ; NOT USED - overlaid by
datawheel
```

```
;; SR Pin Mode
ENC_ENTRY 5, 0, MIOS_ENC_MODE_NON_DETENTED ; V-Pot 1
ENC_ENTRY 5, 2, MIOS_ENC_MODE_NON_DETENTED ; V-Pot 2
ENC_ENTRY 5, 4, MIOS_ENC_MODE_NON_DETENTED ; V-Pot 3
ENC_ENTRY 5, 6, MIOS_ENC_MODE_NON_DETENTED ; V-Pot 4
```

Available Ports

Following interfaces are provided by the dinx4 module:

Name	No. of pins	Description
J1	5	Interface to CORE J9 (if buttons are used) and CORE J6 (if encoders are used, MIDIbox16E only). DINX4 J1 provides two power pins for 5V, 0V, the serial clock, the latch enable and the serial output of the register chain. This port can also be connected with J2 of another DINX module.
J2	5	Interface to another DINX4 module. DINX4:J2 provides nearly the same pins like J1, just only the serial output of the first IC is replaced by the serial input of the last IC. This port can be connected with J1 of another DINX module.
J3 to J9	5	These are the digital input lines, every connector comes with 4 of them and an additional pin for ground. See mbhp_dinx4_32buttons.pdf as an example how to connect buttons to these pins, and mbhp_dinx4_16enc.pdf how to connect rotary

PCB files

- [DINX4 V2 Preview](#)
- [DINX3 V1 Preview](#)
- [DINX2 V1 Preview](#)
- [Preview of DINx1](#) -No pcd as this part is normally built on veroboard.

Schematic

- [MBHP DINX4 V2](#)
- [MBHP DINX1](#)

List of parts

Here are suggested part numbers for various distributors for parts for the DIN board. If you find another site or dealer with a different parts list feel free add it into the list. Also if you've successfully used a different part from what was listed here please add the number and/or link to the list.

Part Name	Description	Polar	soldering temp	QTY	Reichelt.de part# ¹⁾	Mouser.com part#
IC1-IC4	74HC165	Yes	Don't!	4	74HC 165	511-M74HC165
R1-R36	Resistor 10 kOhm	No	???	36	1/4W 10k	264-10K-RC
C1-C4	Ceramic Cap 100 nF	No	???	4	Z5U-2,5 100n	80-C412C104K5R
-	IC-Sockets for serial registers	Yes	???	4	GS 16	571-3902614
J*	1-row SIL Headers (50 pins)	No	???	2	STIFTL. 40G	517-6111TG
-	1-row sil female con	No	???	2	-	517-850-01-36
-	Ribbon cable 3 meters	No	???	3	AWG 28-16G	-

Building it

Building instructions

blah blah blah

Connection to Core Module

Check the version of your Boards; if you're using SmashTV's Core that's equipped with double rows, you can build a split-cable to connect J8/J9 to a DIN and a DOUT:

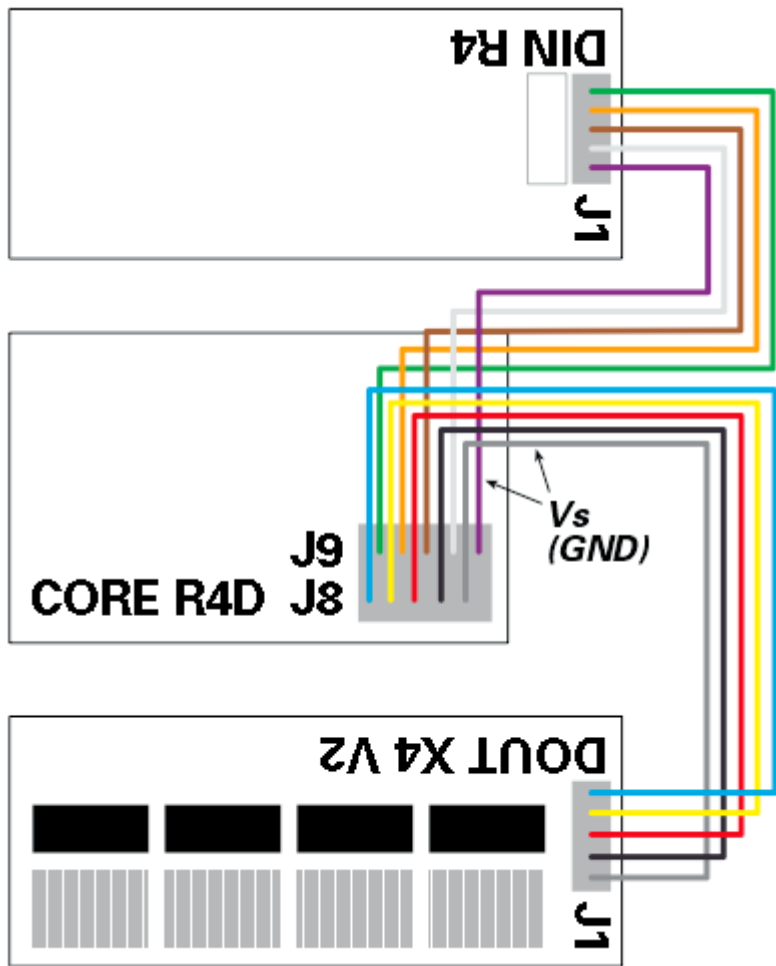

Connecting Input Devices

[Connecting 32 buttons to a DINX4](#) [Connecting 16 Rotary Encoders to the MIDibox16E and other MIOS based controllers](#) [Connecting 16 Alps STEC16B03 Encoders to MIDibox16E and other MIOS based controllers](#) [Connection Diagram for touch Sensors](#)

Testing

Testing all pins

Regardless which MIDibox you are planning to build, you can use the MIDIO128 application to test the digital inputs of the DIN module(s)

Once MIOS and the MIDIO128 application have been uploaded, each digital input will send a Note On event (pin 1-64) or Controller Event (pin 65-128) when a button is pressed (=0V at the digital input pin), and a Note Off event (pin 1-64) or Controller Event (pin 65-128) when the button is released (=5V at the digital input pin). Rotary encoders will send two Events (because they are connected to two pins) depending on the quadrature state.

Each pin will trigger an individual note/CC number. This is the second byte of a event. The first pin will send "90 30 7F" when pressed, and "90 30 00" when released. The last 128th pin will send "B0 4F 7F" when pressed, and "90 4F 00" when released. The MIDI events can be displayed with MIOS Studio or a MIDI monitor (e.g. MIDI-Ox) The MIDIO_OUT_ENTRY definitions in midio128_presets.inc help to map the pins to the events, the [DIN DOUT pin list](#) helps to map the pin numbers to shift register pins.

Testing Shift Register Connections

If the first input pin of the first shift register (74HC165) triggers all 128 Notes at once, there is probably a problem with the Shift or Register Clock line (SC/RC signal). Both signals are driven by the core module, and they are connected to all shift registers in order to scan the chain. If these signals are not connected, or if there is a short, the core will always "see" the first digital pin, and never the remaining pins of the chain.

If some of the last shift registers cannot be scanned, it is very likely that the SC/RC line is broken, that there is a bad soldering, or similar.

Such types of errors can be located with the srio_interconnection_test application, which can be found at the [MIOS download page](#). Step by Step instructions for the testing procedure are described in the main.asm file

Check:

- the SC/RC output at the core module (J8/J9)
- the SC/RC input of each DINX4 module (J1/J2)
- the LD/CLK input of each 74HC165 (Pin #1 and Pin #2, see [DINX4 schematic](#))

If you notice a short circuit (signals always 0V or 5V, or between these voltage levels), check the cables between the modules and especially your soldering at the bottom of the PCB. Consider also, that a PCB track could be broken or connected with another track (etching imperfection).

Connect each single DINX4 module directly to the core in order to find the bad candidate(s).

If visual checks don't help to detect the short circuit, you could begin with a very drastic, but effective method: cut the failing track in the middle, and check if the short has disappeared. Cutting has to be repeated until you've found the cause for the failure.

Warning: Don't do this too early, this should be the last measure which normally leads to success, but also to a bad looking PCB. After this procedure, you have to repair the track with some solder

Troubleshooting

[troubleshooting](#)

Reference

1)

[Reichelt Shopping Cart Links](#)

From:

<https://wiki.midibox.org/> - **MIDIbox**

Permanent link:

<https://wiki.midibox.org/doku.php?id=home:mbhp:module:din&rev=1228249495>

Last update: **2008/12/02 20:24**

