

MIDIbox SEQ V4 Beginner's Guide

The Beginner's Guide is intended to cover the basic operation and concepts of the MBSEQv4 step sequencer. It does not include instructions on how to make the most out of all the features of the sequencer, or what each of the options on every menu page does, but it does give a good overview for the new user.

Most of this guide is based on what can already be found in the "[official](#)" [MBSEQv4 manual](#), and it's not intended to replace that. On the contrary, once you've learned the basics, it's much easier to search the official manual for a particular menu page and check out what you can do with the options that are not mentioned in this guide. This guide is written first of all for new users who are not looking for information on some particular detail, but instead would prefer to have an *overview* of the basics.

What this guide does *not* cover, however, is building the unit, the control surface, where to get the parts etc. It is intended to be useful when you have a completed and working unit at your disposal, preferably with Wilba's frontpanel design.

Also, this guide is based on the premise that you have a MIDI controller connected to the sequencer's MIDI IN1 and a polyphonic synthesizer (mono- or multitimbral) connected to MIDI OUT1 of the sequencer. If you don't, the guide will still be useful, but you'll have to find out yourself where you need to do things differently.

The Wiki allows you to export a PDF version of this page. You might want to store a local version (and print it out) - please click on this link:

1. The basics

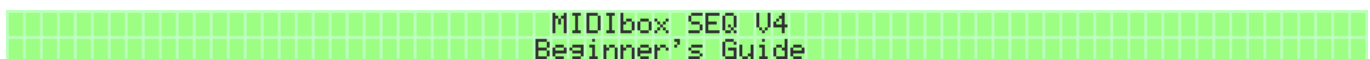

MIDIbox SEQ V4 Beginner's Guide

Before starting with the basics, it's useful to create a new session so that you're be able to explore the sequencer's functions in practice. After switching the sequencer on, press EXIT until you reach the top menu, where you can choose options like 'Open' and 'New' on the right LCD. Choose 'New', and then wait until the sequencer has created the session.

The default new session has sixteen tracks that are almost similar.

- All tracks are Note type tracks
- Track length is 16/256 steps
- Divider/Timebase setting is 16
- Port is Def.

Only the MIDI channel setting is different, each track having its own MIDI channel (1-16) on which the track is sending data.

1.1. User interface

The physical user interface consists of buttons, indicator leds, two LCD displays, and 17 knobs. In this guide the buttons are referred to with their names in ALL CAPS, i.e. MENU means the menu button, PLAY mean the play button etc.

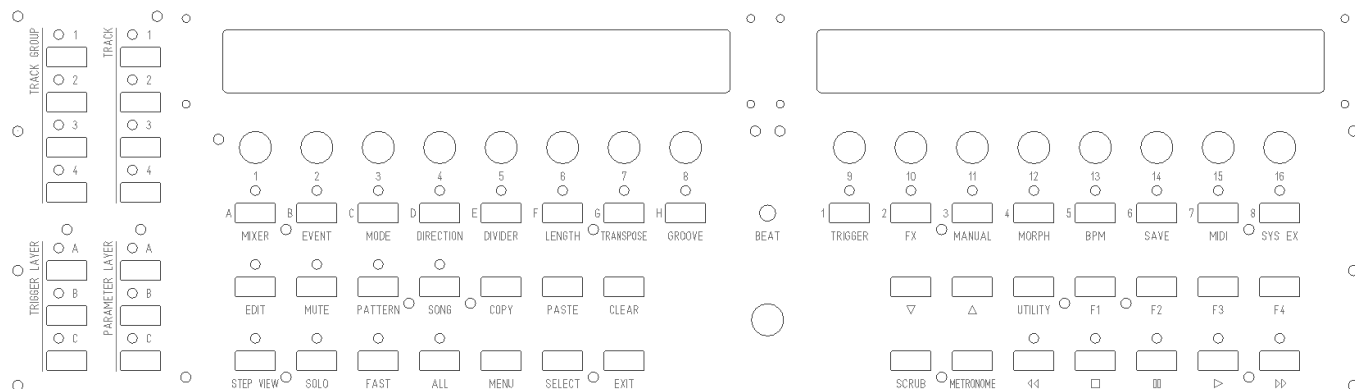

The sixteen numbered buttons immediately below the LCDs and knobs are referred to either with their button names (LENGTH, DIVIDER, FX etc.), especially if they are used together with the MENU button; or if they are used without the MENU button, they are called *general purpose buttons*, or GPBs for short (usually with a number, e.g. GPB7 for the 7th GPB from the left). Often the menu pages, too, are called with their button names (EVENT for the Track Event page etc.), to indicate the means to get to that page quickly.

All knobs are called *general purpose knobs*, or GPK for short (also with numbers) with the exception of the big knob in the middle of the panel, which is called the datawheel. The displays are called the left LCD and right LCD.

The unit should have at least one physical MIDI IN and one physical MIDI OUT port, and that's taken for granted in this guide (it is likely you'll have four of each). These will be called MIDI IN1 and MIDI OUT1, or just IN1 and OUT1.

The top menu page. Use the datawheel to scroll through the various menu pages on the left.



Almost all of the menu pages can be reached by pressing EXIT (once or a few times, depending on where you are) to get to the top menu, then using the datawheel to browse the options on the left LCD and finally pressing a GPB to select the menu you need. However, with Wilba's frontpanel layout most menus are only one or two button presses away. Some menus/functions have their own dedicated button, while many others can be brought up by pressing MENU together with one of the GP buttons. The MENU button, along with several others, can be configured in the HW setup file (see Appendix 1) to be momentary or toggle. "Momentary" means the function is active as long as you keep pressing the button, while "toggle" means you press once to activate the function, and another time to deactivate it. You can choose whatever you prefer; the notation in the guide will be of the form MENU + [BUTTON_NAME].

Various options on the screen will be written between apostrophes. For example, if reference is made to the save function on the main menu, the option is written as 'Save'; if you are advised to press a button to initialise the active track, you are told to select the 'INIT' option, etc. Also, 'on' and 'off' will be written between apostrophes to indicate that they denote a binary state instead of grammatical pre- or postpositions.

Many buttons have indicator LEDs associated with them. These LEDs will tell you whether something (out of many possible options) is selected, or whether some mode or function is toggled 'on' or 'off'. The 16 LEDs directly below the knobs are step indicator LEDs which will tell you something of the state of the step. In addition, when the sequencer is running you will see a red cursor LED indicating which step is being played and how fast the progression from one step to another will be. Above the datawheel, there is a tempo LED, blinking quarter notes.

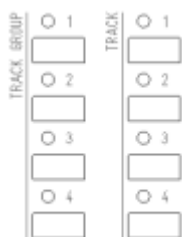

On the left side of the frontpanel there's two groups of buttons which deserve special mention. The eight buttons on the top left are the *group and track selection buttons*. The left column selects a group (1-4), the right column selects a track within the selected group. (More on groups and tracks in section 1.2.) The LEDs indicate which group and track is currently selected, though the information is often available on the LCDs as well (most often on the left edge of the left LCD).

You can select multiple tracks at once *within a group* by pressing & holding one track selection button and then pressing the others one by one; press another time to deselect. (Any combination of tracks can be selected on the Track Selection page, which is available only as a F1-F4 button or as a saved bookmark; for customising F1-F4 buttons, see Appendix 1, and for bookmarks, see Appendix 2.)

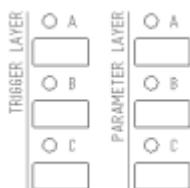

Below the group and track buttons there are six more buttons for *layer selection*. The left column is used to select *trigger layers* of the selected (active) track, and the right column is used to select *parameter layers* of the selected track. (More on layers in section 3.)

In a new session, trigger layer button A selects the gate trigger layer, button B selects the accent trigger layer and button C brings up a menu of all the trigger layers, allowing you to choose the one you need with the GP buttons. You can have a maximum of 8 trigger layers, except on drum tracks, where the maximum is two.

In a new session, parameter layer button A selects the note parameter layer, button B selects the velocity parameter layer, and button C alternates between length and roll parameter layers. Each of the default session's tracks has four parameter layers, but if your track has more than four parameter layers, button C brings up a menu, allowing you to choose the layer you need with the GP buttons. You can have up to 16 parameter layers, except for drum tracks where the maximum is two.

1.2. Basic concepts

1.2.1. Groups, tracks, patterns and banks

MBSEQv4 is organised into *groups*, *tracks* and *patterns*. Patterns are stored into four *banks*.

There are four *groups* of tracks, and *each group has four tracks*, so all in all there are 16 tracks. Group 1 always holds the tracks 1-4, group 2 always holds the tracks 5-8 and, group 3 the tracks 9-12 and group 4 the tracks 13-16. In MBSEQv4 shorthand language, groups and tracks are referred to with the formula GxTx. For example, G1T3 means “Group 1, Track 3” (i.e., track 3 out of 16), and G3T4 means “Group 3, track 4” (i.e., track 12 out of 16).

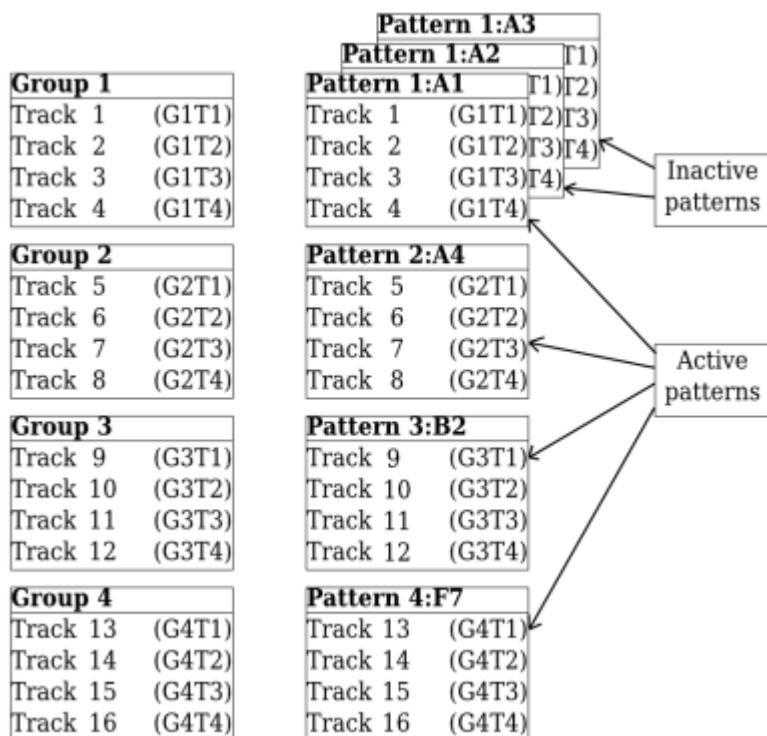

Tracks contain the data – gates, accents, notes, note velocities, CCs etc. – that you've programmed in them and that is sent over to your MIDI equipment. This data is in *trigger layers* and *parameter layers*. (For details, see section 3.)

In addition to the musical data, tracks also contain settings data. Defining the settings for each individual track is one of the most complicated operations a new user has to face, because of all the interconnections that are not immediately self-evident. The flipside is that track setup offers a lot of possibilities. Some settings (like the MIDI Router settings, see Appendix 4) are independent of any session.

Most of the time one track is selected and visible on the screen. This is the *active track*, the track that's ready for editing. You can always tell which track is selected by looking at the group and track selection LEDs (on the left of the frontpanel); most of the time the active track is also named on the left edge of the left LCD (“G1T1”, “G2T4” etc.). By selecting several tracks simultaneously (with the track selection buttons, or on the Track Selection page) you can also edit several tracks simultaneously, e.g. to set their length. In this case the selected track on the left LCD will be of the form GxTM, where 'M' stands for 'multiple'.

By default, initialisation switches the gates 'on' for every 4th step. In the options menu (UTILITY Opt. Option #11) you can disable this effect, so that initialisation inserts no notes in the track.

Initialisation works for only one track at a time, even if you have several tracks selected. Only the track that's being displayed on the LCDs, the active track, will get initialised.

Let's take the first two tracks in Group 1 (i.e. G1T1 and G1T2). At the very least you need to set their type, length, port and MIDI channel. These settings are made on the EVENT page (MENU + EVENT).

Make the following settings for G1T1 and G1T2:

- *Track type should be "Note"*
- *Maximum length should be 128 steps*
- *Port should be 'Def.' (or 'OUT1')*
- *the MIDI channel (Chn.) should be whatever your synth is listening to (you must know the right channel yourself)*

The port (that's where your synth is physically connected to) is going to be the same for both tracks in this example, but it still has to be set separately for each track. As to the MIDI channel, the simplest solution is that you set both tracks to the same channel, so they're both playing the same (polyphonic) synth. If you have a multitimbral synth, you could use G1T1 to play a lead sound on one synth and G1T2 to play a bass sound on another, but it's ok if both tracks are playing the same sound (as long as your synth is polyphonic).

If your synth is monophonic, you will have to apply the following according to your best judgement, because it's written for, and has been tested with, a polyphonic synthesizer.

Select G1T1 with the group and track selection buttons. To get a track that is of the type "Note" and 128 steps long, turn GPK2-4 on the EVENT page until the type is "Note" and "Steps" is 128. This will automatically set the correct layer numbers as well. Initialise the track by pressing GPB16 for a few seconds.

Next, select the correct port and MIDI channel. Use the GP knobs to set Port to 'Def.' and Chn. to whatever channel your synth is listening to (you will have to know yourself what the right channel for your equipment is).

Then push track selection button #2 to select G1T2. You will notice that you stay on the same menu page (the EVENT page), but the information you see now pertains to track G1T2. Make the same Type, Steps/Layers, Port and MIDI channel selections for G1T2 as you did for G1T1, and initialise the track.

2.1.1. Track types

On the MBSEQv4, track selection possibilities are organised into several predefined options based on track type, length (number of steps), number of parameter layers, and number of trigger layers (the options are listed below).

Changing the track type allows you to select different kinds of track presets that best suit your purposes. The track types are Note, Chord, CC and Drum, and each of these types has subtypes based on a combination of maximum track length, number of parameter layers and number of trigger layers. (For the difference between parameter layers and trigger layers, see sections 3.1. and 3.2.) Because of memory limitations it's not possible to have the longest possible track (256 steps) with the maximum number of parameter and trigger layers (16 and 8, respectively), so each subtype is a compromise within the overall limitations.

Note, Chord and CC tracks always have 8 trigger layers, so in effect the track has to be balanced between maximum length and the number of parameter layers. Drum tracks are somewhat different from the other types, so they are dealt with separately. (See section 3.3.).

Mode	Steps	Param. layers	Trig. Layers	Instruments
Note	64	16	8	1
Note	128	8	8	1
Note	256	4	8	1
Chord	64	6	8	1
Chord	128	8	8	1
Chord	256	4	8	1
CC	64	16	8	1
CC	128	8	8	1
CC	256	4	8	1
Drum	64	1	2	16
Drum	128	2 (32 steps)	1	16
Drum	128	1	2	8
Drum	256	2 (64 steps)	1	8
Drum	64	1	1	16
Drum	128	1	1	8
Drum	256	1	1	4

When changing track type, the track needs to be *initialised* for the changes to take effect. Press GPB16 for a few seconds to initialise the track. Initialisation erases all data in the track's layers!

It is important to note that even though initialising a track to the selected preset fixes the number of parameter layers, you can, after initialisation, freely change what *kind* of parameter layers you have. The difference between Note, Chord and CC type tracks is just in what the *default* parameter layer functions are; a CC type track contains only CC parameter layers, while Note type tracks contain none of them, but nothing stops you from from changing the parameter layer functions to whatever you like after initialisation (naturally within the maximum overall number set at initialisation). Only drum type tracks are different in this respect. (See section 3.3.)

Indeed, you will have access to many parameter layer functions (like Pitch, Delay and Probability) only this way, as they won't be available in any of the presets. On the EVENT page, use GPK9 to choose which parameter layer you want to edit (from A to H, if you have eight parameter layers), then turn GPK10 to set which function you want to control with that parameter layer. You need to confirm the change of function by pressing GPB10 (the seq will tell you this). Note that if you change parameter layer functions, e.g. from Roll to Nth1, you will lose all parameter values in the Roll layer.

2.1.1.1. Note tracks

In a default session, all tracks are of the same type: they are Note tracks that are 256 steps long and have four parameter layers. This kind of Note type tracks have one velocity layer (parameter layer B), one length layer (parameter layer C, for note length, not track length!), one roll layer (parameter layer D), and one note layer (parameter layer A). If you initialise a shorter Note track, you just get more note layers (parameter layer E and onwards); if you want other kinds of parameter layers, you have to set them manually on the EVENT page (see section 2.1.1.). Maximum length of 128 steps gives you four extra note parameter layers compared to the default, allowing you to enter up to five note chords, and that should already be enough for most purposes.

The setting Sustain on the MODE page is good to keep in mind when setting up a track to play chords or long single notes. Sustain holds each note/chord until another one is played on the track, and this spares you the trouble of having to set the length of each individual note/chord.

2.1.1.2. Chord tracks

Chord tracks are set up length and layer wise just like note tracks. However, in a chord track, parameter layer A is a chord layer instead of a note layer. The chord layer doesn't take normal notes as input, but instead a value from A-P to a-p (plus octave value from 0 to 3), each of which represents a pre-defined chord. The list of the predefined chords is found below.

The advantage of this to using several note layers on a note type track to play chords is that you can have the chord data on a single layer, even if the chords are made up of 4 notes. Because you only need a single parameter layer for chords, you can increase your track's maximum length to 256 steps. A disadvantage is that the value names don't make musical sense, though the names of the chords do appear on the right LCD (top row). A bigger disadvantage is that in order to play chords with different root notes (and not just different chords of the same root note, like C major, Cm, Csus4 etc.), you need to set up a loopback track to transpose each chord. (See section 6.1.)

There are two chord parameter layers, called 'Chord' and 'Chrd2'.

List of predefined chords for layer 'Chord':

- A-C: Major I, Major II, Major III (transposed variants)
- D-F: Root note, 3rd note, 5th note (single notes)
- G,H: Root+3rd, Root+5th
- I-N: Maj6, Maj7, Maj8, Maj9, Maj10, Maj12 (4-note chords)
- O,P: Sus4 and Maj+
- a-c: Minor I, Minor II, Minor III (transposed variants)
- d-f: Root note, 3rdMin note, 5th note (single notes)
- g,h: Root+3ndMin, Root+5th
- i-n: Min6, Min7, Min8, Min9, Min10, Min12 (4-note chords)
- o-p: Co7 and Min+

List of predefined chords for layer 'Chrd2':

- A-C: Pwr5, Pwr8, R+mj3
- D-F: R+min3, Maj, Sus4

- G-I: Maj+, Maj6, Maj7
- J-L: add9, Maj9, Maj11
- M-N: Maj13, Min
- O-P: Min6, Min7
- a-c: Minad9, Min9, Min11
- d-f: Min13, Dom7, 7Sus4
- g-i: Dom9, Dom11, Dom13
- j-l: 7b5, 7#5, 7b9
- m-n: 7#9, DimTri
- o-p: Dim, m7b5

Note that some of the chords in Chord2 layer have more than four notes. You can use both chord layers to send note data to an arpeggiator track (see section 6.1. for details), but the arpeggiator function will receive only four notes. If you send chord layer chords with more than four notes, only the last four notes of the chord will be accepted; the earlier ones are ignored.

If the length of a chord track allows more than 4 parameter layers, by default all the extra ones will be note layers. However, it is not really possible to play chords and melodies simultaneously on the same track, because each parameter layer shares the one and only gate trigger for that track. Thus you cannot trigger individual gates for the notes of the melody in a note layer, while leaving the gate untriggered for the chord layer at the same time. If you go to Layer View (press & hold EDIT + GPB3; see section 4.2. for details on different EDIT modes), you can insert notes in the note layers by turning a knob, but it's only feasible in the same steps where there is already a chord and where the gate is already on.

The setting Sustain on the MODE page is good to keep in mind when setting up a track to play chords (whether transposed or not). Sustain holds each note/chord until another one is played, and this spares you the trouble of having to set the length of each individual note/chord.

Given the complexities of the chord track, for the beginner it is probably easier to just initialise a note type track with four or more note layers (maximum length 128 steps or less), and record the required chords there as several simultaneous notes. (For recording, see section 4.)

2.1.1.3. CC tracks

CC tracks allow you to send Control Change messages to your MIDI equipment. By default, all parameter layers of a CC type track are CC layers that do the same thing, i.e. they send CC messages. By default, each newly initialised CC layer is 'off'. On the EVENT page you can switch them 'on' and set which CC number each layer is sending. Use GPK9 to choose a CC layer and GPK11-13 to choose which CC number that layer sends. Confirm your selection by pressing GPB10.

For example, if you want the first CC parameter layer (layer A) of your newly initialised CC track to send modulation wheel messages, select layer A with GPK9. Then turn GPK11-13 all the way to the left to choose CC number 001, and then confirm the selection with GPB11-13. Then go back to the EDIT page and choose the CC layer you just set up (press parameter layer selection button A). You can see your CC number selection on the top row of both LCDs: "PA:#001" (instead of PA:COff) on the left, and "CC# 1" (instead of "CC#off") on the right. Now you can use the knobs to enter a CC value for each step, simulating the position of the

2.1.3 Track Event and Track Instrument

While on the EVENT page, you can switch between two pages by pressing GPB8: Track Event, which is the default when entering the EVENT page, and Track Instrument. On the Track Instrument page, the port and channel settings will be the same as on the Track Event page (and will be automatically copied between the pages), but in addition you can set a Program Change command and name for the track so that you remember better which synth and what kind of line the track is playing, for example.

Top: Track EVENT page, bottom: Track Instrument page.

Trk.	Type	Steps/ParL/TrgL	Port	Chn	Trk.Layer	controls		
G1T1	Note	64 16 8	USB1	1	Inst A	Note		PRESETS INIT
Trk.	Port	Chn.	PC	BnkH	BnkL	Trk. Edit		
G1T1	IIC2	12	---	---	---	Evt Name	xxxxxx-xxxxxxxxxxxxxxxxxxxx	

When you've reached a point where you have many songs saved on the sequencer, it would be awkward to dial in the right synth patches by hand on every synth whenever you change to another session, so it's super handy that you can use this page to set program change messages to switch to those patches automatically, when you press PLAY and start the sequencer. Note that not all synthesizers will be able to change patches "in zero time". (Note also that the actual functioning of this option relies on your gear and patch setup having stayed the same, something not always easily guaranteed!)

The Program Change command is saved with the track when you save a pattern, so when you chain patterns into a song, the Program Change command can be used to change the patch on the synthesizer that is listening to that track at the same time as the pattern is changed. Note that smooth live functioning of this feature depends on how quickly your synths can load new patches. If this is causing problems, Program Change commands can be sent also on a parameter layer dedicated to this purpose, allowing you to time them more flexibly, so that your equipment has time to react (see section 3.2.10. for details). Note, however, that *sending Program change messages simultaneously from the Track Instrument page and the Program Change parameter layer may lead to conflicting commands!*

If you press GPB9 on the Track Instrument page, you go to the Edit Name page. Naming the track has two components. The first component of the name is a *category* like lead, bass, pad, FX, drums, keys, your-synth-name, or whatever you can fit into 5 letters. The second component is a more detailed name for the actual sound/patch/whatever that is played on that track.

For example, the tracks could be named with the categories Lead (tracks 1-4), Keys (tracks 5-8), Bass (9-12) and Drums (13-16). As to the second component, they could be named them after the synths that are played by that channel, including the MIDI channel that track is sending on, and let the Program Change messages take care of the patch change (many synths show the patch names on their displays). Punching in the letters works the same way as writing an SMS on a mobile phone.

One of the tracks could be called "Lead - Synth So-and-so ch6", and this information would be visible when you're on the EDIT page (left LCD, top row). It is handy to have the MIDI channel there too, because the track numbers don't necessary match the MIDI channels they are

sending on (it depends on your setup). It's not necessary to name the tracks at all, though. If you don't, you will just see "[Port] [MIDI channel]" as the name, and "NoCat" as the category.

Back on the Track Event page there is finally 'PRESETS', which can be used to save and load content and settings for tracks. Presets are not session dependent, so this is a way to move tracks and track settings between sessions. (This is especially useful for drum tracks, if you've changed the default name and note settings for all 16 drum instruments.) Another way is to prepare and save a "basic" session with common/standardised settings, and then every time you want to start a new session, you can open the basic session and save it under a new name.

Presets can be saved in the right LCD by pressing GPB14-15 ('PRESETS'), then GPB11-12 ('SAVE AS NEW PRESET') and then giving it a descriptive 8-character name.

In the left LCD, you can recall saved presets. Selecting one of them brings up a menu where you can delimit which track data you want to import. Name and Chn. are self-explanatory, Maps means mixer maps (see section 6.5.), and Steps means trigger layer and parameter layer data. What Cfg. (configurations) refers to is too much to go through here in detail, but in brief it means all other track settings apart from MIDI channel and port, i.e. settings such as track MODE, LENGTH, DIRECTION settings, FX settings etc. (See Appendix 4 for details.)

2.1.4. Setting parameter layer functions

Finally, the EVENT page allows you to customise your parameter layers. Use GPK9 to select the layer and GPK10 to select the function for this layer. The default sessions has four parameter layers, and by default parameter layer A controls note, layer B controls note velocity, layer C controls gate length, and layer D controls roll. (For parameter layer functions, see section 3.2.) You can set these functions to any of the available options, if you don't like the defaults.

If you change parameter layer functions, e.g. from Roll to Nth1, you will lose all parameter values in the Roll layer.

2.2. Track LENGTH

The maximum length of a track is determined when the track is initialised, and cannot be changed unless you reinitialise the track. However, it is possible to make the track play *shorter* than the maximum length. This can be done on the LENGTH page. Turn GPK2-3 to set the length, or alternatively you can press GPB9-16 to quick-select a common length.

Trk.	Length	Loop	QuickSel	Quick Selection: Length							
G1T1	16/32	1	Length 4	8	16	24	32	64	128	256	

Unless otherwise specified, all 16 tracks in the four active patterns will run independently of each other, sharing only the tempo. Different track lengths mean thus that eventually the tracks will end and restart at different times, and the effect is cumulative: a track that is four steps shorter than the others will restart four steps before the others, and on the next round, 8 steps before the others etc.

For more on this topic, see sections 2.3. (Track DIVIDER and Tempo), 5.2. (Phrase mode and song mode), and 5.4. (Measure) with its subsections.

Select G1T1 and go to the LENGTH page. Set the length of the track to 16 (so the display will show 16/128), then select G1T2, and set the length to 8 (so that the display will show 8/128).

Now you have two tracks that are of different length. Select G1T1 and press EDIT. Track initialisation has probably entered some notes in the track which are not wanted, so press CLEAR to get rid of them.

Punch in some notes with the GP buttons under the displays. For the first track you, for example, could punch in every other button, i.e. steps 1, 3, 5, 7, 9, 11, 13 and 15. Each GP button press will produce the note C-3, and if you press again, you can delete it. Let's leave the notes there for now, though, so press a GP button for another time if you deleted any notes.

Next, select G1T2, CLEAR the track and punch in the notes as with the first track, but then use the GP knobs under the notes to adjust the value of each note so that the first two become E-3, the next two become G-3, and the four last ones become G-2.

Remember that the second track is only 8 steps long. If you punched in the notes on the right LCD as well (like you did with G1T1), it does no harm, but they will not get played unless the track length is set to 16 steps. However, let's keep the track length at 8 for the purposes of this demonstration, and despite the shortened length, let's keep the notes on the right LCD.

Everything should now be ready. Press PLAY on the front panel to start the sequencer. If you still have G1T2 selected, you will see a red indicator LED running from left to right. It will go up to the eighth step and then start again from the first step. Now select G1T1 (while the sequencer is still running), and you will see how the red cursor is running all the way up to step 16, and then starts from the beginning. Try turning one of the GP knobs to change one note one up or down on each track. You can also press MENU + LENGTH while the sequencer is playing and use the quick select buttons on the right display to change the length of a track live.

You can change the length with the knobs as well, but there you'll run a higher risk of making the tracks go out of sync. If this happens, you can always stop the sequencer and hit PLAY again.

The idea of this was to demonstrate in a concrete way that the tracks are running independently of each other, even if they are within the same pattern. You could press STOP, change G1T1's length to some strange value like 11, press PLAY again, and each track would run its length and then wrap back to the start, regardless of where the other track is going.

2.3. Track DIVIDER and tempo

2.3.1. Tempo

Even though by default the tracks are running independently of each other, they share the same tempo for reference. This can be set by pressing MENU + BPM. The BPM (beats per minute) setting can be adjusted with GPK3 and GPK4, or alternatively with Tap Tempo by pressing GPB16 five times in a row. Alternatively, pressing & holding MENU and pressing PLAY five times can be used for the same purpose. In both cases, the fifth press will also start the sequencer. Toggling on FAST (left side, bottom row on the frontpanel) you can change how the GP knobs for adjusting BPM behave. An LED on the front panel, above the datawheel, will flash every quarter note.

```
Mode Preset Tempo Ramp Fire Preset MClk In/Out Delay Ext. Tap
Auto 3 132.0 0s Preset Page USB1 I:on O:on 0mS Restart Tempo
```

2.3.2. Divider

You can make each of your tracks run faster or slower compared to the others by changing the divider/timebase value. If you want *all* of your tracks to run faster or slower, it makes better sense to just change the tempo (MENU + BPM), but if you need only a few individual tracks to run faster or slower than the rest, then changing the divider/timebase value for those tracks is a good idea.

```
Trk. Clock Divider Synch to Measure Quick Selection: Timebase
G1T1 16 (normal) yes 1 2 4 8 8T >16< 16T 32
```

The DIVIDER page offers two ways to change the divider value: either by changing it directly with GPK2 (and GPK3 for normal/triplet), or by quick-selecting a common timebase value with a GP button. The former allows for great precision, but the latter makes more human sense and is probably the more useful option for most situations.

Normally you would use timebase 16 (divider value 16), which in simple terms means that when you're on the EDIT page, every step on the two displays (8 steps per display = 16 steps altogether) represents a 16th note, allowing for four note (or other) events per quarter note. If, on the DIVIDER page, you select timebase 8 (divider value 32), each of the 16 steps on the EDIT page now represents an 8th note, allowing for two note events per quarter note (the BPM LED above the datawheel always shows the length of the quarter note). Timewise, the track lasts twice as many seconds as before, but what is gained in duration is lost in resolution (possible events per quarter note). In the same vein, quick-selecting timebase 4 (divider value 64) means that each step represents a quarter note, and so on.

The divider value can be set to normal or triplet (in the quick select menu triplet is denoted with a T). Triplet option can be used to effect "triplet timing" for that track, but in that case you might want to have the track set to "sync to measure". (See section 5.4.) Of course, you can realise triplet timing with the "normal" divider setting as well and without "sync to measure", provided that the resolution of the track is enough to allow the adequate placement of notes.

If you change the timebase value while the sequencer is running, you risk the track becoming out of sync with the others unless you're right on the beat. This is even more true of changing the divider value *directly* with GPK2, as by default the tracks won't sync automatically when you've reached the right divider value. For ways to fix this asynchrony, apart from simply stopping the sequencer and then pressing PLAY again, see section 5.4. on Measure.

It is probably a good idea to limit divider/timebase changes to a small number of tracks, otherwise you won't remember which ones were playing a custom timebase (and which custom one).

Two example cases where changing the divider/timebase value is useful are 1) fast melody tracks and 2) slow chord tracks.

You might have a lead track where the default 16th notes are not enough for the melodies you want. If the other tracks are 64 steps long and their timebase is the default 16 (divider value 16), you could set the lead track to 128 steps, running at timebase 32 (divider value 8). Each step on the displays now represents a 32th note. This way the longer track would reach its end at the same time as the other tracks, but you could effectively write your melody with 32th notes.

If you need 64th notes, quick select options have run out and you have to use GPK2 to change the divider value to 4.

Slow divider settings, on the other hand, are useful e.g. for tracks which play chords that don't change very often. For example, if your "chord track" is 64 steps long, you could set its timebase to 4, i.e. four times as slow, and fit all your chord changes in the two displays on the EDIT page. This way you can see the relevant note information easily, without the need to scroll back and forth around the track.

Set G1T1 LENGTH to 16/xx, G1T2 LENGTH to 8/xx, and G1T1 and G1T2 dividers to timebase 16. Then press PLAY. If you switch between G1T1 and G1T2 with the track selection buttons, you will see they are running at equal speed. (It's good to be on the EDIT page for the best demonstration of this.) STOP the sequencer and select G1T1, then go to the DIVIDER page and quick-select timebase 32 (divider value 8) by pressing GPB16. Press PLAY. You can see the red cursor running twice as fast as before for G1T1, and playing the notes twice as fast. Each step on the EDIT page for G1T1 now represents a 32th note, and G1T1, which has 16 steps, will now run from start to end as quickly as G1T2, which is only 8 steps that represent 16th notes.

Now let's make G1T2 run twice as slow compared to the original speed. You can change the timebase when the sequencer is playing, but unless you're right on the beat, the tracks will go off beat (and even more certainly with changing the divider value live with a knob). So, press STOP, change G1T1's timebase back to 16, and then change G1T2's timebase to 8 (divider value 32). Press EDIT and PLAY again, and you can see how the cursor is running slower, and the notes are playing slower. Also, the tracks are ending at the same time, because even though G1T2 is twice as short as G1T1, it's also twice as slow.

3. Trigger layers and parameter layers

On the lower left corner of the front panel there are three trigger layer selection buttons (A, B, C) and three parameter layer selection buttons (A, B, C). These allow you to select different layers for editing. Editing is done either with the GP button under each step (for the active trigger layer) or with the GP knobs under each step (for the active parameter layer).

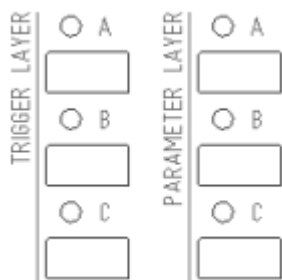

By default, trigger layer selection button A selects the gate layer, B selects accent, and C brings up a page where you can select one of the eight trigger layers with a GP button. (Drum tracks have only 1-2 trigger layers, for these see section 3.3.)

With parameter layer selection buttons, button A selects the first parameter layer and B selects the second parameter layer. If your track has only four parameter layers, button C alternates between parameter layers C and D. If you have more than four parameter layers, button C brings up a page where you can use a GP button to choose one of the available parameter layers. (Drum tracks have only 1-2 parameter layers, for these see section 3.3.)

Trigger and parameter layers hold most of the data that makes up your music, such as gates, notes, note lengths, CC values etc. In order to understand what recording a note actually does, first it is necessary to say something about these two kinds of layers.

One trigger layer and one parameter layer are always selected, and thus active, ready to be edited with the GP buttons (for triggers) and GP knobs (for parameters) below each step. The active layers are named on the EDIT page (left LCD, top row). "Px: Name" gives the active parameter layer, where x is the layer (A-P) and "Name" the name of the layer, such as Vel. (velocity), Len. (length), etc. "Tx: Name" gives the active trigger layer (A-H) and the name of the layer, such as Gate, Roll, etc.

```
G1T1 Def. Chn 1 PA:Note TA:Gate Step 1 G#1 Vel:127 Len: 75% NoCat
G#1 ---- A#1 ---- G#1 ---- A#1 ---- G#1 ---- A#1 ---- G#1 A#1 A#1
```

3.1. Trigger layers

Note, Chord and CC type tracks always have eight trigger layers. Drum type tracks are a special case, and have 1 or 2 trigger layers; they are dealt with in a separate section (see section 3.3.).

A trigger layer always has one of two values: 'on' or 'off'. Whether a trigger layer is 'on' or 'off' can be seen by selecting the layer (with the A, B or C buttons) and checking if the LED under the step is lit or not. If it's lit, the trigger of the selected layer is 'on' for that step, and if it's not lit, the trigger is 'off'. The active trigger layer's name is visible on the EDIT page on the left LCD's upper right corner. (E.g. "TB:Acc.", for "Trigger layer B: Accent".)

You can set which trigger layer controls which trigger function on the TRIGGER page (MENU + TRIGGER). The page displays a list of all available trigger functions (nine) and their assignments into the trigger layers (max. eight). Turn a GP knob to change the function for each layer. Note that normally all trigger layers apart from RollG (see section 3.1.9.) are available by default (drum tracks are an exception). Note also that you can control multiple triggers with a single layer. For example, by assigning both Gate and Accent trigger to trigger layer A, every time you trigger a note with Gate, it

will also be played at Accent velocity.

Gate	Acc.	Roll	Glide	Skip	R.G	R.U	NoFx	RollG
>A<	B	C	D	E	F	G	H	-

3.1.1. Gate

Gate is the basic trigger, without which other layers (whether trigger or parameter) cannot express themselves. Gate controls whether the data in the step is going to be played or not. If gate is 'on', the contents of the step's layers will be played, and if it's 'off', it will be treated as an empty step, even if there is data in the other layers of the step.

You can see this for yourself by pressing & holding EDIT, which brings up a menu where you can choose the type of EDIT view you want. Choose 'Trigger View'. The left display shows eight trigger layers, and the right display shows the first eight parameter layers. (If you need to see the rest of the parameter layers, you can choose 'Layer View', which shows all available parameter layers.)

If you select G1T1 and use GPK1 to view Step 1, you can see that Gate is 'on' (), and all the other triggers are 'off' (o). As to the parameter layers, you can see that note, velocity and length layers have something in them. Now use GPK1 to select Step 2. All the information in the steps stays the same, only the gate flag is turned 'off' (o). If you switch back to step view (press & hold EDIT), you can't see anything on the display for step 2, because gate is 'off'. But if you press GPB2, you will create a C-3. Where did that come from? It was in the step all the time, your button press just turned the gate on, and made the information in the step "visible".*

3.1.2. Accent

If the Accent trigger is 'on' (*), it simply means that the step will be played at maximum velocity (127), i.e. "as loud as" it can be played. Velocity values simulate the force with which you strike a piano key: the higher the value, the "harder" the note is played. However, synthesizers often allow many other variables to be controlled with the velocity value, so it depends on your synth's settings what velocity actually does.

3.1.3. Roll

If the Roll trigger is 'on', it means the note in the step will be played two times in quick succession within that step (a kind of flam). This allows only very simple rolls. For more detailed control over the roll in a parameter layer, see section 3.2.4.

Note that the Roll trigger won't work if the Sustain setting on MODE page is on.

3.1.8. No FX

If this trigger is set 'on', the step won't be forwarded to FX functions like echo, humanizer and limiter. (For effects, see section 6.6.)

3.1.9. Roll gate (RollG)

RollG trigger layer is used together with Roll and Roll2 parameter layers. This trigger is not assigned to any trigger layer by default. You can assign it to one of the available trigger layers on the TRIGGER page (MENU + TRIGGER), but normally you don't need it. See section 3.2.4.1. for details on how and when to use RollG.

3.2 Parameter layers

A parameter layer always has a value between 0 and 127. It can be in plain numerical form (0-127) or it may appear as a combination of letters and numbers, like e.g. for notes and roll values. The values can be adjusted with the GP knobs below each step.

The parameter layer to be edited is selected with the parameter layer selection buttons (lower left corner of the front panel). Button A selects the first parameter layer (which is a note layer in a newly initialised Note type track), button B selects the second parameter layer, and button C brings up a menu where you can choose any available parameter layer with the GP buttons. (Or, if you have only four parameter layers, button C alternates between the 3rd and the 4th layer.)

Note that all steps will have Note, Velocity, CC etc. values in them by default, but they are effective only if the gate trigger is set 'on'. On the EDIT page, the active parameter layer name can be seen on the left LCD. "PA: Note" means "Parameter layer A: Note", i.e. the first (= A) note layer is active, "PB: Vel." means the Velocity layer is active, etc.

3.2.1. Note

Note layers contain the notes which the sequencer is going to play. If you have several note layers, you can use them to play several notes at once, e.g. for chords. (See section 4.)

Note that the note layers are not independent of each other, because each track has only one gate trigger layer which is shared by all the note layers of the track. Hence, it is not possible to have each note layer play their own line, each layer having its own gate, length etc. Multiple note layers are useful for playing multi-note chords in each step, but e.g. piano-style two-handed play with some notes held down longer in one note layer, while other notes play "broken chord" arpeggios in another note layer is not possible with just one track. You would need to dedicate a separate track (perhaps sending on the same MIDI channel) to each "hand".

Example: The following will work:

Note Param.	layer 1	C-3	----	----	----	C-3	----	----
Note Param.	layer 2	E-3	----	----	----	F-3	----	----
Note Param.	layer 3	G-3	----	----	----	A-3	----	----

The following will work:

Note Param.	layer 1	C-3	E-3	G-3	E-3	C-3	F-3	A-3	F-3
Note Param.	layer 2	----	----	----	----	----	----	----	----
Note Param.	layer 3	----	----	----	----	----	----	----	----

The following will work too, but it will sound exactly the same as the example above, plus it's more work:

Note Param.	layer 1	C-3	----	----	----	C-3	----	----
Note Param.	layer 2	----	E-3	----	E-3	----	F-3	F-3
Note Param.	layer 3	----	----	G-3	----	----	----	A-3

3.2.2. Velocity

At its simplest, velocity controls how loud the note in the step is to be played. Velocity values simulate the force with which you strike a piano key: the higher the value, the "harder" the note is played. However, synthesizers allow many other variables to be controlled with the velocity value, so it depends on your settings what velocity actually does.



The velocity layer shows the velocity value as a vertical bar next to the note layer value (from the first note layer). The note layer value is merely displayed, and cannot be edited when the velocity layer is visible (and vice versa), because the GP knob is used to edit the velocity value, not the note value.

3.2.3. Length

Gate length per step allows you to adjust how long a note will sound. Length is expressed as a percentage for each step, from 1% to Gld. (=100%). Length can be stretched over several steps by adjusting the gate length until the value for that step says "Gld." (for glide), and then adjusting the next step's length until "Gld.", if you want to sustain the note to yet another step, and so on. You can stop at any step when you've reached the length that you like by leaving the length value in that step anywhere below 100% (glide). The "stretched over" steps should have their gate triggers switched 'off'.

3.2.4.1. Using the RollG trigger layer

You can use the trigger layer RollG together with the Roll and Roll2 parameter layers. Normally it should be enough to just set the trigger layer Gate (=the normal gate trigger, by default in trigger layer A) 'on' for a step and then, for the same step, turn a knob to enter a value in the Roll/Roll2 parameter layer. The sequencer will play a roll in all steps where the Gate trigger is 'on' and where there is a non-zero value in the roll parameter layer.

However, if you have one roll value that you would like to use all over your track, normally you'd have to enter the roll values by turning the knob for each step individually, wherever you want to effect a roll. RollG offers another solution. Instead you can push the ALL button, set the cursor to step 1 and then turn GPK1 to enter the same roll value in every step of the track with just one knob. If you have only the Gate trigger layer (typically in trigger layer A), every step with the gate trigger 'on' will now play a roll, and you cannot play any non-roll notes. But if you now assign RollG trigger to trigger layer B on the TRIGGER page, rolls don't get triggered anymore unless you explicitly set them to trigger on the RollG trigger layer.

In other words, now the "normal" gate layer can be used to trigger just the "normal" notes, but if Gate and RollG are 'on' *together* for the same step *and* there's a value in the roll parameter layer, a roll note is triggered instead. (Alone, RollG has no effect.)

This way you can enable and disable the roll value for each note with a single press of a button, instead of having to turn the knobs to zero with each individual step. Or, instead of the ALL button trick to enter multiple values simultaneously, you can also use the Randomiser function to randomise the values of the roll parameter layer (for details on the randomiser function, see section 6.3.), and then trigger them with the RollG layer.

Normally, the gate trigger 'on' state is indicated with a "◆". However, if both the normal Gate *and* RollG are on for the same step, *both layers* will indicate this state of affairs with a "⊙". If you have RollG set 'on' for a step, but the normal gate is 'off' for that step, both layers will display an "o".

3.2.5. Chord and Chrd2

Chord layers can be used to play chords with up to 4 ('Chord' layer) or 6 ('Chrd2' layer) notes in a single parameter layer. For the details on the chord layer, see section 2.1.1.2.

3.2.6. Control Change (CC)

CC layers can be used to send Control Change messages to your MIDI equipment. For the details on the CC layers, see section 2.1.1.3.

3.2.7. Pitch

Pitch layer can be used to send pitch wheel events to your MIDI equipment, simulating the pitch wheel position. Value 64 (default) is the middle position, i.e. no effect.

3.2.8. Probability (Prob)

Probability layer can be used to set the probability for the step to be played (0–100%). This is especially useful for drum tracks to increase variation without creating multiple tracks. (See also random gate trigger, section 3.1.6.)

3.2.9. Delay

Delay layer can be used to delay each step with 1–96 microticks. Regardless of tempo, one step is 96 microticks long, so delaying a step with 96 microticks plays the step at the last possible instance within that step before moving into the next step.

3.2.10. Program Change

Program Change parameter layer (PrgCh) allows you to send Program Change messages to your MIDI equipment. This is useful if you want to change patches in the middle of a track. However, this requires that your MIDI equipment can effect patch changes quickly enough. On the other hand, if your MIDI equipment cannot handle the Program Change commands set on the Track Instrument page (see section 2.1.3.) quickly enough, Program Change parameter layer offers a solution: if you want your next pattern to play with a changed patch, you could use the Program Change parameter layer to effect the patch change during the current pattern, early enough so that the patch is ready when the next pattern starts.

Note that sending Program Change messages simultaneously from the Track Instrument page (see section 2.1.3.) and the Program Change parameter layer may lead to conflicting commands!

The default value for every step on a new Program Change parameter layer is 0. The layer sends a new Program Change message only if the value changes from one step to the next, so a 16 step layer filled with "0" sends the command only once. If you don't want the track to send anything, use the ALL button & function (see section 4.2.3.) and turn the GP knob all the way to the right: the last value (—) will have the step send nothing.

3.2.11. Nth1 and Nth2

Parameter layers Nth1 and Nth2 allow you to create long variant patterns which change based on mathematical rules. Nth1 will trigger the specified action the first time and then each nth bar, while Nth2 will start triggering only after n bars, and then each nth bar.

The possible actions are:

1. Pl: Play each nth bar
2. Mu: Mute each nth bar
3. Ac: Accent each nth bar
4. Ro: Roll each nth bar
5. Fx: enable Fx each nth bar
6. Nx: disable Fx each nth bar

The first selectable “operation” (- 2 etc.), before Pl, is actually a dummy value. It does nothing and can be ignored. The final operation (“?? 1” etc.) is currently empty, and also does nothing.

Below is an example sequence and how it will actually sound. The operation for both steps is “mute”, and because the parameter is Nth1, muting starts immediately from the first occurrence, and then repeats every second (for step 2) or fourth (for step 4) time.

	step1	step2	step3	step4	
note param. layer	C-3	D-3	E-3	F-3	
Nth1 param. layer	---	Mu2	---	Mu4	

This is the actual outcome of the settings above:

	step1	step2	step3	step4	
note param. layer	C-3	---	E-3	---	first iteration
note param. layer	C-3	D-3	E-3	F-3	second iteration
note param. layer	C-3	---	E-3	F-3	third iteration
note param. layer	C-3	D-3	E-3	F-3	fourth iteration
note param. layer	C-3	---	E-3	---	fifth iteration

With the same settings but with Nth2 parameter, muting would start only on the second time the note is played (for step 2), and then every second time (for step 2) in the example above. If the Nth layer was Nth2 instead of Nth1 in the example above, the outcome would be:

	step1	step2	step3	step4	
note param. layer	C-3	D-3	E-3	F-3	first iteration
note param. layer	C-3	---	E-3	F-3	second iteration
note param. layer	C-3	D-3	E-3	F-3	third iteration
note param. layer	C-3	---	E-3	---	fourth iteration
note param. layer	C-3	D-3	E-3	F-3	fifth iteration

3.2.12. Root

The Root parameter layer allows for the selection of a root note locally. The default value is “Glb”, which means that for the selected step, the root note is the same as the global root note (set in MENU + FX → Scale with GPK3; see section 6.2. Force To Scale for details). While in the FX page's Scale menu it is possible to select “Keyb” for entering a root note via a keyboard, on a Root track only absolute values (from C to B) are allowed.

The setting on the Root layer overrides the global root setting for each step in the track where the value is other than “Glb”.

The track using a Root layer must be in Normal mode, not in Transpose or Arpeggiator mode (MENU + MODE).

Using a Root parameter layer in a track makes it easier to use the Chord and Chord2 layers on the same track, because there is no need to set up a controlling track to control the root note of another track (see section '6.1. Using a bus to control a track' for the details on this). For example, you could use only one type of chord, a major chord, on the chord layer of a track, and control whether it is a C major, F major or G major with the Root note track.

3.2.12. Scale

The Scale parameter layer allows for the selection of scale locally. The default value is “Glb”, which means that for the selected step, the scale is the global scale (set in MENU + FX → Scale with GPK4-8; see section 6.2. Force To Scale for details).

The setting on the Scale layer overrides the global scale setting for each step where the value is other than “Glb”.

The list of available scales, with ordinal numbers, is on the FX → Scale page; thus the major scale is number 0 (“0:Major” on the display), and harmonic minor is number 1 (“1:Harmonic Minor” on the display). However, the limited notation on the Scale track only allows for the use of the ordinal numbers for scales, so you have to remember that number 0 denotes the major scale, number 16 the mixolydian scale etc.

The list of the available 166 (!) scales with their ordinal numbers and names is available in pdf form [here](#).

3.2.13. Aftertouch

The Aftertouch parameter layer allows for the sending (and recording) of channel aftertouch events. The default value for a new Aftertouch layer is “0”.

3.3. Drum tracks

Drum tracks are suitable for playing up to 16 drum sounds simultaneously, with each drum instrument having its own instrument layer (bass drum, snare drum, hihat, clap etc.). In addition to the instrument layers, a drum track can have either 1 or 2 parameter layers, and 1 or 2 trigger layers. Like with the other track types (see section 2.1.1.), here too it's a zero sum game between track length, number of instruments and number of trigger/parameter layers.

Trigger layer length is always the same as track length. However, parameter layer length can be shorter than track length. If, for example, track length is 256 steps, but parameter layer length is 64 steps, the parameter layer will get repeated four times ($4 \times 64 = 256$) while the track plays its 256 steps.

The drum track type notation differs somewhat from the other tracks.

StepsP/T	Drums	
(64/2*64)	16	Track length is 64 steps, two trigger layers. One parameter layer (length 64 steps). 16 different drum sounds can be played.
(2*32/128)	16	Track length is 128 steps, one trigger layer. Two parameter layers that are 32 steps long, which means they will repeat four times while the track goes through its length of 128 steps. 16 different drum sounds can be played.
(128/2*128)	8	Track length is 128 steps, two trigger layers. One parameter layer (length 128 steps). 8 different drum sounds can be played.
(2*64/256)	8	Track length is 256 steps, one trigger layer. Two parameter layers that are 64 steps long, i.e. they repeat four times while track goes through its length of 256. 8 different drum sounds can be played.
(64/64)	16	Track length is 64 steps, one trigger layer. One parameter layer that is 64 steps long; 16 different drum sounds can be played.
(128/128)	8	Track length is 128 steps, one trigger layer. One parameter layer that is 128 steps long. 8 different drum sounds can be played.
(256/256)	4	Track length is 256 steps, one trigger layer. One parameter layer that is 256 steps long. 4 different drum sounds can be played.

3.3.1. Drum track instrument layers

Unlike other track types which can control only one instrument, a drum track can control up to 16 instruments, and this results in somewhat changed controls. Parameter selection button C has no function, because for a drum track two parameter layers is the maximum, and trigger layer selection button C is used to bring up a submenu of the available *instrument* layers, instead of trigger layers (the maximum number of trigger layers also being two).

In order to set up a working drum track, you have to make sure that the note values for each of the instruments match what your drum machine expects for each instrument. This is done on the EVENT page (right LCD). Choose the drum instrument with GPK11 and the matching note with GPK12. For example, by default MBSEQv4 assumes that a bass drum sound is equal to the note C-1, but this may be different from what your drum machine thinks a base drum note is. You have to know the settings of your drum machine to set up the equivalent values on the sequencer (or vice versa).

You can also rename the drum instruments, if you don't like the defaults. This too can be done on the EVENT page by pressing GPB8 for 'Track Instrument'. There you can scroll through the available

instrument layers (A-P) with GPK10, see the name of each drum instrument on the right, and rename it by pressing GPB9. Maximum name length is five characters.

Once you have set up the drum notes and names to your liking, you probably want to save the whole thing as a preset; go back to Track Event page (GPB8) and press GPB15 ('PRESETS').

3.3.2. Drum track trigger layers

A drum track will always have at least one trigger layer, and that is gate. If the gate trigger layer is selected (left LCD top row says "TA:Gate"), the steps in an instrument layer can be toggled 'on' or 'off' by pressing a GP button below the step. A "◆" indicates that the gate is 'on' for that drum instrument layer.

If there is more than one trigger layer, the second one is Accent by default. The second trigger layer can be selected by pressing trigger layer selection button B (left LCD top row says e.g. "TB:Acc"); pressing a GP button below the step toggles the trigger 'on' and 'off' for each step.

For the accent layer, a "◆" means normal velocity (it's 'on' if the gate for that step is 'on'), and "○" means accent velocity. The normal velocity value as well as the accent velocity value for each drum instrument layer can be set on EVENT page with GPK13 and GPK14 (VelN for normal and VelA for accent velocity; range 0-127). Only Accent layer has these extra settings.

You can change the second trigger layer by pressing MENU + TRIGGER and assigning trigger layer B to one of the options on the page with the knobs. You can change layer A too, but you really need the gate layer, so in practice changing it isn't so useful. Note that you can assign many functions in a single trigger layer. For example, by assigning both Accent and Roll into trigger layer B, each step where trigger layer B is set 'on' will trigger both Accent and Roll for that step.

3.3.3. Drum track parameter layers

Drum track parameter layers can be set to the desired function on the EVENT page with GPK9 and GPK10 (not all functions are useful). By default a single parameter layer is Roll, and if you have two parameter layers, they are Velocity and Roll. Parameter layer functions can be changed on the EVENT page with GPK9 and, if you have two parameter layers, GPK10.

The parameter values can be adjusted for each step in each drum instrument layer by turning a GP knob (you have to be on the EDIT page). Turning the knob will summon the selected parameter layer, which will be visible as long as the value is changed; after a few seconds of inactivity the display will return to the gate on/off view.

4. Entering notes

There's a few ways to enter notes on the sequencer when you're on the EDIT page.

The most simple option is to press a GP button to trigger Gate 'on' or 'off', and turn the knob below the step to adjust the note value. The default note is C-3, the default velocity is 100, and the default length 75%. This method is good only for single notes, because pressing a GP button only toggles the gate 'on' or 'off', and thus just “enables” the note value (and any other parameters) that happens to be stored in that step. By default there is one C-3 note in a single note layer in each step of a newly initialised Note type track, but if you have recorded multiple notes in the step previously, then switching the gate 'on' will enable these multiple notes (and other events you have recorded in the step).

For a drum track's instrument layers this method works best.

However, this is not really “recording notes”, rather it's just pushing a button to toggle the gate 'on' or 'off' for a step. The actual recording options and settings are available on the Jam page.

4.1. The Jam page

You can enter the Jam page by pressing UTILITY + GPB10 ('Jam'). However, as the Jam page is likely to be used quite often, it might be useful to set one of the four function buttons (F1-F4, on the right hand side of the frontpanel) to take you directly to the Jam page to make transitioning between EDIT and Jam pages as easy as possible. (For this you need to edit the HW setup file, see Appendix 1.)

The Jam page consists of two stand-alone settings (Rec and Fwd) and five groups of settings: Step, Live, Pattern, MIDI, and Miscellaneous. The groups can be selected with GP buttons, the editable settings of the selected group appearing on the right LCD.

However, before getting down to recording notes, something must be said of the MIDI Configuration page.

4.1.1. MIDI Configuration

The MIDI Configuration page is available from the main menu, or with MENU + MIDI \square GPB1-2 ('Transposer and Arp.'). However, you can access it also on the Jam page by pressing GPB7 ('MIDI'). The MIDI configuration settings are independent of the session, i.e. they are in force in all session.

```
Trk. Rec. Fwd. Configuration Pages Bus Port Chn. Lower/Upper Mode Reset
G1T1 off on Step Live Ptn.>MIDI<Misc 1 IN1 #16 --- --- Jam Stacks
```

On the MIDI configuration page, GPK9 allows you to select one of the four buses for editing. A bus is a virtual port (as opposed to a physical port such as OUT1 or OUT2), which allows you to route data inside the sequencer, instead of routing it directly to a physical output port.

The MIDI configuration page allows you set limitations to which MIDI messages get passed on to the bus.

- 1) Mode sets which of the two functions, Jam or T&A (Transpose & Arpeggiator), this bus is set to.
- 2) Port can be set to allow input from all input ports ('All'), or from a single input port.
- 3) Chn. can be set to allow input from all MIDI channels ('All'), from a single MIDI channel, or no MIDI channel ('- - -'). If you want to disable a bus, set the channel setting to '- - -'.
- 4) Lower/Upper can be set to allow input across the whole keyboard ('- - - G-8'), or from a narrower range. 'Lower' sets the lowest note allowed through, and 'Upper' the highest note.

Jam bus block chart:

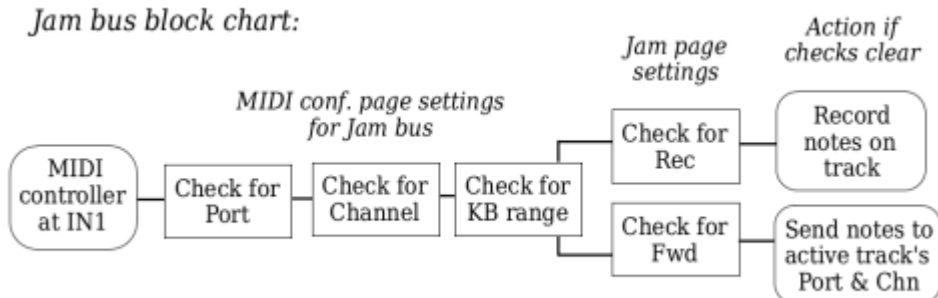

T&A bus block chart:

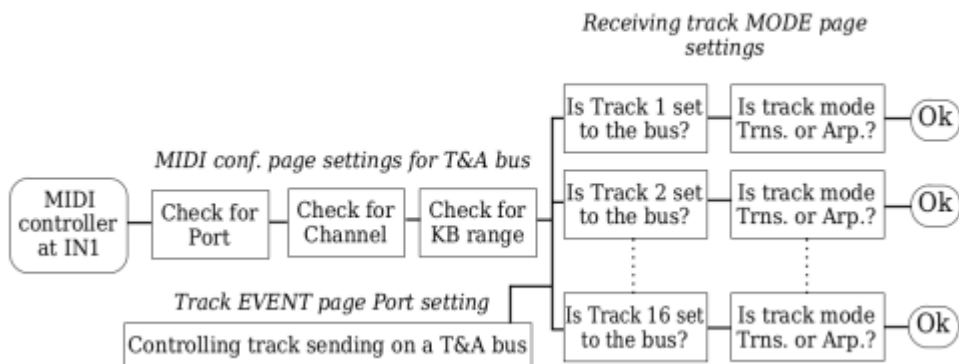

If the incoming MIDI data passes through the port, channel and keyboard range limitations, *and* the Jam page Fwd is set 'on', the bus that is set to the 'Jam' function will receive the incoming data and forward it to the active track's output port and MIDI channel. *This is done regardless of the active track's bus settings* (on the track's MODE page) (see section 6.1.1. for details on the MODE page). If Fwd is 'off', the active track will still receive the data, e.g. for recording purposes, but Fwd needs to be 'on' if you want to hear what you play (whether you're recording or not). (On note forwarding, see the next section, 4.1.2.) The limitations set on the MIDI Configuration page apply to recording and note forwarding as well as the transposer and arpeggiator functions.

The alternative bus function to 'Jam' is 'T&A', which means 'Transpose & Arpeggiator'. See section 6.1. for details on how to use buses 2-4 for Transposer and Arpeggiator functions.

Recording and live note forwarding is possible only through the Jam bus. Anything coming through on a T&A bus cannot be used for recording. This is why one bus has to be set to 'Jam' (GPB14) - otherwise recording and note forwarding won't work.

Note that the Force To Scale function (see section 6.2.) uses the T&A bus to control the root note of the chosen scale, if the root note it set to be controller by the keyboard.

Perhaps the most practical solution is to reserve Bus4 for Jam, and buses 1-3 for T&A. The reason is that by default, each track is listening to Bus1 (set on the MODE page). However, each track's mode (on the MODE page) is 'Normal' by default, so the data coming through on the bus has no effect. But if you want to control that track's transpose or arpeggiator with another track, all you need to do is set the sending track's Port (on the EVENT page) to send on Bus1, and change the receiving track's mode to Transpose or Arpeggiator. (See section 6.1. for details on how to set up sending and receiving tracks.)

It is likely that you want to be able to play and record on every MIDI channel and via every physical input port. To effect this, set the Mode of a bus to 'Jam', and Port and Chn. to 'All' on the MIDI Configuration page. In addition, set the Lower/Upper settings to "- - -" and "G-8", respectively. This permits data from all input ports and MIDI channels all across the keyboard to go through to the active track, and from there, if Fwd is 'on' on the Jam page, on to the active track's output port and MIDI channel.

If your MIDI controller is connected to IN1 and sending data on channel 1, if the MIDI Configuration page's Port, Chn. and Lower/Upper settings allow this data through, and if Fwd is 'on', it doesn't matter which MIDI channel the active track is forwarding the data out on. If your controller is sending on channel 1, but the active track's MIDI output channel is 6 (set on the EVENT page), effectively you're playing your controller on channel 1 to control a synth that is listening to MIDI channel 6.

The final option on the MIDI Configuration page is 'Reset Stacks'. This is useful for special situations, where e.g. a MIDI controller has become detached from the MBSEQv4 while some notes were still active (for example, you might have tripped over your own cables while performing live!); because of the sudden detachment, the sequencer might never receive a Note off event, and as a result some notes might be left hanging. 'Reset stacks' clears all note stacks. The option can also be used for resetting the last sent Transpose or Arpeggiator note/chord.

4.1.2. Rec and Fwd

Rec (GPB2) sets recording mode 'on' or 'off'. Recording mode needs to be 'on' if you want to record notes with just pressing keys on your MIDI controller, i.e. without need to touch the sequencer's buttons or knobs. You can record notes also by two other ways when Rec is set 'off' (see section 4.1.4. for Edit recording mode), but *in all cases* recording notes takes its settings from the Jam page.

When Rec is 'on' and you're on the EDIT page, the cursor position > - - < angle brackets turn into { - - - } curly brackets to indicate that you are in recording mode. A message to that effect ("STEP/LIVE RECORDING") will also be displayed on the left LCD.

Rec stays 'on' even if you leave the Jam page, and you can record notes regardless of which page you are on. However, you won't see what you record unless you're on the EDIT page or the Jam page. If you start recording while on the Jam page, the display will switch to the EDIT page (where 'STEP/LIVE RECORDING' will flash on the left LCD) as long as you keep recording notes, but after a few seconds of inactivity you will be returned to the Jam page. A more convenient way is perhaps setting Rec 'on' and then going to the EDIT page (by pressing the EDIT button), where you can now take your time to

record the notes you like, and scroll back and forth if needed, without having to worry about getting automatically returned to the Jam page.

Recording works regardless of whether the sequencer is running or stopped. Most of the time recording makes practical sense only in Phrase mode, where patterns are not switching, because switching to another pattern erases all unsaved changes. (For Phrase and Song mode, see section 5.2.)

Fwd (GPB3) sets note forwarding 'on' or 'off'. If Fwd is 'on', it means that the notes you play (whether you're recording or not) are forwarded immediately to the Port and MIDI channel (set in the tracks' EVENT page) of the active track. If Fwd is 'off', you won't hear the notes when you play/record them, even though playback does work regardless of the Fwd setting. Note that the Jam bus settings on the MIDI configuration page (see section 4.1.1.) must allow the MIDI messages through for note forwarding and recording to work.

Whether or not to keep Fwd 'on' depends on your equipment and setup. For example, some MIDI Router settings (MENU + MIDI \square MIDI Router, see Appendix 3) can cause notes to become triggered twice per key press, if Fwd is 'on'. For a simple setup, however, setting Fwd 'on' is probably a good idea.

4.1.3. Step recording

On the Jam page, press GPB4 to choose Step recording settings for editing. They appear in the right LCD.

```
Trk. Rec. Fwd. Configuration Pages Mode AStart Step Inc. Toggle
G1T1 off on >Step<Live Ptn. MIDI Misc Poly on 1 + 1 Gate
```

Mode can be set to either 'Poly' or 'Mono'. 'Mono' allows you to record only one note at a time, and always in the first note layer, overwriting any notes that already were there, while 'Poly' allows you to record as many notes simultaneously as you have note layers on the track you're recording on. (The number of available note layers depends on how you have set up the track; see section 2.1.1.) Both modes overwrite whatever was in the note, velocity and length layers for each recorded step. If a step had several note layers with notes in them (i.e. a chord) and you record a single note in that step (which always goes in the first note layer), all the other note layers are erased as well.

In mono mode you will have access to Inc (increment) setting, which allows you to effect an automatic step increment after recording a note in a step. For example, Inc setting '+2' means that after recording the first note (e.g. in step 1), the cursor will jump forward two steps (e.g. into step 3). This way you can spare yourself the trouble of adjusting the cursor position by hand, if you know that you want to record notes in a steady rhythm. Inc setting is not available for poly mode, which means you have to adjust the cursor by hand.

AStart controls whether or not to start the sequencer automatically when you press a key on your MIDI controller to record the first note. If the sequencer is already running, AStart setting makes no difference. Note that if the sequencer is not running and AStart is 'off', recording will always be step recording (and will use step recording settings from the Jam page), even if Live recording is selected on the Jam page, and even if 'LIVE RECORDING' is flashing on the display. Step recording with AStart 'on' or the sequencer already running is not affected by the tempo, but only by the increment setting.

The Step setting indicates the cursor position on the EDIT page. The position can be changed on the EDIT page with the datawheel, and the cursor position is copied to the Jam page, but with Step (GPK11) you can change the cursor position while on the Jam page as well. Turning the knob takes you briefly to the EDIT page, and after a few seconds of inactivity you will be returned to the Jam page.

You can step record CC messages the same way you can record notes. There are two alternative conditions: either the incoming CC message number has to have a dedicated CC parameter layer already, or there is a CC layer that is currently 'off'. For example, an incoming CC#001 will be recorded in the first CC layer where there already are CC#001 messages, or if there is no such layer, the CC#001 message will be recorded into the first free CC layer. If there are no available CC layers, the incoming messages won't be recorded anywhere.

4.1.4. Live recording

On the Jam page, press GPB5 to choose Live recording settings for editing. They appear in the right LCD.

```
Trk. Rec. Fwd. Configuration Pages Mode AStart Quantize  
G1T1 off on Step>Live<Ptn. MIDI Misc Poly on 10%
```

Mode can be set to either 'Poly' or 'Mono'. 'Mono' allows you to record only one note at a time, and always in the first note layer, overwriting any notes that already were there, while 'Poly' allows you to record as many notes simultaneously as you have note layers on the track you're recording on. (The number of available note layers depends on how you have set up the track; see section 2.1.1.) Both modes overwrite whatever was in the note, velocity and length layers for each recorded step. If a step had several note layers with notes in them (i.e. a chord) and you record a single note in that step (which always goes in the first note layer), all the other note layers are erased as well.

AStart controls whether or not to start the sequencer automatically when you press a key on your MIDI controller to record the first note. If the sequencer is already running, AStart setting makes no difference. Note that if the sequencer is not running and AStart is 'off', recording will always be step recording (and will use step recording settings from the Jam page), even if Live recording is selected on the Jam page.

Note also that with Live recording, if you have AStart 'on', the first note will always be recorded in step 1, regardless of the cursor position, and all subsequent notes will be recorded at the running cursor position.

Quantize can be set from 0% to 99%, and it controls the tolerance with which "early" off-beat notes will be recorded in the *following* step, instead of in the step where they technically were played. The higher the value, the more likely it is that an "early" note will be recorded into the next step.

Note that when note forwarding (Fwd) on the Jam page is 'on' and an "early" note is moved by the quantize function to the next step, the note will be triggered twice. When you press a key on your MIDI controller, the note is immediately forwarded to the port and MIDI channel for that track (because Fwd is 'on'), and sounds for the first time. Because it was a bit early, it is moved "into the future", i.e. the next step, but the sequencer won't be there for another 0.2 seconds or so. However, when the sequencer does reach the next step, it will play the note that was moved there, the note

that had sounded already a fraction of a second before.

The image below is a caption of four steps, where the player is live recording, aiming at steps 5 and 8. If quantize is set to 50 % (pretty aggressive), the first note will be recorded in step 5, where it was played, but the second note will be moved to step 8, even though it was played in step 7.

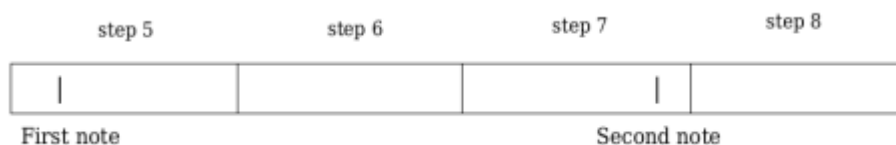

You can record CC messages live the same way you can record notes. There are two alternative conditions: either the incoming CC message number has to have a dedicated CC parameter layer already, or there is a CC layer that is currently 'off'. For example, an incoming CC#001 will be recorded to the first CC layer where there already are CC#001 messages, or if there is no such layer, the CC#001 message will be recorded into the first free CC layer. If there are no available CC layers, the incoming messages won't be recorded anywhere.

Let's say you want to record live a sequence where the notes come down on steps 1, 5, 9 and 13. If Quantize is set to 0% and during live recording you press the keys for the second and third notes just a bit too early, the sequencer shows no mercy and the notes will be recorded in steps 1, 4, 8 and 13, instead of step 1, 5, 9 and 13 like you wanted. (The first note will always be on time if you start live recording with the first key press.) Quantize allows you to "cheat" a bit, and by increasing the setting you can have these "a bit too early" notes recorded into the next step instead. The percentage controls the definition of "a bit too early".

4.1.4.1. Follow Mode

When you record notes live, the sequencer doesn't follow the running cursor position by default. The sequencer will jump to the current 16-step section of the track every time you record a note, but if you don't record notes for some time, the cursor will soon leave the screen. If you want to follow the running cursor position when the sequencer is running - whether it's during live recording or just playback - you can enable the Follow Mode with MENU + EXIT. (The same combination also disables the mode.)

Switching the Follow Mode 'on' will result the sequencer always displaying the 16-step section where the running cursor is at; when the running cursor leaves the screen, the display is changed to the next 16-step section or, if the track ends, back the beginning of the track. However, in this case you cannot use the datawheel to scroll from one 16-step section to another, when the sequencer is stopped. You have to switch Follow Mode 'off' to do that.

4.1.5. Live Patterns

The Live Patterns function allows you to effect rhythm patterns that have either been prepared earlier, or ones that are created and/or edited live. Live patterns play “on top of” the track, without overwriting anything, but the patterns can also be recorded on the track if needed. Each session has its own set of live patters, and they cannot be imported to other sessions.

```
Trk. Rec. Fwd. Configuration Pages Drum Ptn. Pattern 1 Length  
G1T1 off on Step Live>Ptn.<MIDI Misc BD on *.*.*.*.*.*.*.*. 75% CpyPaste
```

Live patterns are useful especially for spicing up Drum type tracks, though they can be used for other track types as well. The patterns can be activated with MIDI controller keys, and their playback velocity can be controlled with aftertouch (note that many MIDI controllers don't support aftertouch). The Live Patterns page 'Ptn.' can be found on the Jam page (GPB6), and the Live Patterns menu is available on the right LCD.

The sequencer has to be running and the Jam page function Fwd has to be set to 'on' for Live Patterns to work. Note that having Fwd 'on' might conflict with your MIDI Router settings. (For details, see Appendix 3.)

4.1.5.1. Live Patterns for Drum type tracks

As a Drum type track is probably the most likely candidate for Live Patterns use, the functions will be covered in detail with drum tracks, and only the few differences explained in the next section with regard to other track types.

For a Drum type track, the Live Patterns page allows you to effect one of 16 different live patterns for any of the available drum instruments. Select the drum instrument that you want with GPK9. 'Ptn.' setting turns the live patterns function 'on' and 'off' for the selected drum instrument.

If 'Ptn.' is 'off' for a drum instrument, pressing the appropriate key on your MIDI controller for e.g. a bass drum sound (the key which each drum sound is associated with is set on the drum track's EVENT page) will both play the drum instrument in question and select it for pattern assigning. If 'Ptn.' is 'on', pressing & holding the appropriate key for e.g. a bass drum sound will not play a bass drum sound, but instead will keep effecting the chosen live pattern as long as the key is held.

The live pattern will be played with the velocity with which you hit the key on your MIDI controller. If your MIDI controller sends aftertouch messages, the velocity of the pattern can be controlled with aftertouch. If you want maximum control over the velocity of the live pattern, press the controller key very softly, and then use only aftertouch to control the playback velocity. If you hit the key hard, that will determine the initial velocity of the pattern, but after applying aftertouch, it is the aftertouch amount that will keep determining the playback velocity of the live pattern.

Note that if Rec on the Jam page is 'on', your key presses will be recorded in the track. If Rec is 'on' while also Ptn. is 'on' (GPB10), recording on the track will take place only for those steps where the current live pattern is triggered. If you just want to effect the live patterns when you press a key, but don't want to record anything on the track, make sure Rec is 'off'.

Live patterns will be played “on top of” the “normal” track. For example, if you have a bass drum playing quarter notes on the track and you effect a live pattern on any drum instrument, the “normal” track will keep playing in the background normally (it won't get muted, overwritten etc.), and the live pattern is played in addition to it, fill-style.

There are 16 live patterns per session, and each pattern is always 16 steps long.



You could select one live pattern for several drum instruments, set 'Ptn.' to 'on' for each of them, and then use the MIDI controller keys to effect the selected patterns for the selected drum instruments simultaneously.

The live patterns can be edited live while you're on the Live Patterns page. Press & hold SELECT to enter the edit mode (“EDIT” will appear in the right upper corner of the right LCD). While SELECT is pressed & held, you can use the GP buttons to turn each of the 16 steps of the current live pattern 'on' and 'off'. Accent can be effected for each step by pressing a GP button for a turned-on step another time, in which case that live pattern step will be played at maximum velocity, regardless of aftertouch value. A “◆” denotes normal velocity (controlled by aftertouch), and a “○” denotes accent velocity (no aftertouch sensitivity).

While on the Live Patterns page, you can copy the current live pattern either with GPB15 ('Cpy') or with the dedicated COPY button on the frontpanel. Likewise, while on the Live Patterns page, you can paste the copied live pattern with GPB16 ('Paste') or with the dedicated PASTE button on the frontpanel. This means that the COPY and PASTE buttons won't copy or paste the *track contents* as they normally do. Also the CLEAR button on the frontpanel has a specialised function while you're on the Live Patterns page: it clears the current live pattern instead of the track.

The Length setting (for note length) has no effect on a Drum type track.

4.1.5.2. Live Patterns for other tracks types

If the track is a Note, Chord or CC type track, the basic operation principles are the same as with a Drum type track. Compared among themselves, Note, Chord and CC type tracks work almost identically, though Note tracks are probably the most useful of the three. Only Note tracks will be dealt with here.

Compared to Drum type tracks, there are two differences. First, Length (GPK14) adjusts the note length of each step (up to 98%).

Second, the Mode option (GPK9) changes from drum instrument selection to Mono/Poly selection. This is a recording setting, the same as on the Jam page's Step and Live recording pages. Mono allows you to record single notes, and Poly allows you to record multiple notes. Like normally with recording, you cannot record multiple notes unless you have enough note layers.

If Rec is 'on' while the Ptn. is 'on' (GPB10), recording on the track will take place only for those steps where the current live pattern is triggered. If you just want to use the live patterns when you press a key, but don't want to record anything on the track, make sure Rec is 'off'.

4.1.6. Miscellaneous settings

The settings on the Misc. page work only with the Jam page Fwd setting 'on', and they have effect only on the *forwarded* notes that you play on the keyboard, not on anything that's playing in the track. If the track is forced to scale (on the MODE page), it doesn't affect the forwarded notes that are played live on a MIDI controller, and likewise, the FTS setting (on the Misc. page) doesn't affect the notes on the track. (See section 6.2. for details on Force To Scale.)

Trk.	Rec.	Fwd.	Configuration	Pages	Oct.	Fx	FTS
G1T1	off	on	Step Live Ptn.	MIDI>Misc<	+0	on	on

Oct. effects an octave transpose to the forwarded notes, but leaves the track notes untouched (the track transpose is controlled from the TRANSPOSE page); FX enables/disables Humanizer, LFO, Limiter and Echo effects for the forwarded notes; and FTS enables/disables Force To Scale for the forwarded notes. The scale that the notes are forced to is taken from the FX Scale page. (See section 6.2. for details on Force To Scale.)

4.1.7. Edit recording mode

Besides Live and Step recording, there is one more way to enter notes while on the EDIT page: the Edit Recording mode. Edit Recording mode can be used in two ways. While on the EDIT page, you can press & hold a GP button, and the >- -< angle brackets will turn into {- -} curly brackets, the display will flash 'EDIT RECORDING', and you can enter a note or notes into the step while pressing & holding the GP button.

Note that Edit Recording mode takes its settings (notably Mode and AStart) from the Jam page, so e.g. unless you have Poly mode enabled there, you won't be able to record multiple notes simultaneously; if the mode is Mono and you press several keys, they will all be forwarded if Fwd is 'on', but only one of them will be recorded. Likewise, if AStart is 'on' and you use Edit Recording mode to enter notes, the sequencer will start automatically when you enter notes. Note also that Rec doesn't have to be 'on' for Edit Recording mode to work; if Rec is on and you're on the EDIT page, you don't need Edit Recording mode to record notes.

Alternatively you can press SELECT while on the EDIT page to *toggle* Edit Recording mode 'on' or 'off'. This allows you to play e.g. two-handed chords, as you don't have to use one hand to hold down a GP button.

4.2. Working on the EDIT page

Of all the pages of the MBSEQv4, you will probably spend most your time on the EDIT page. The default view is the Step View, where you can see 16 steps at a time, but only two layers: one parameter layer and one trigger layer. The active parameter layer is displayed on the LCDs, the values can be changed with the GP knobs, and the name of the layer is displayed in the left LCD's top row (e.g. PB:Vel. for "Parameter layer B: Velocity"). The active trigger layer name is displayed in the left LCD's top row (e.g. TB:Roll for "Trigger layer B: Roll"), and the trigger can be switched 'on' or 'off'

for each step with the GP buttons. The LEDs below each step will indicate whether the trigger is 'on' or 'off' for each step. If the LED is lit, the active trigger layer for that step is 'on', and if it's unlit, the trigger is 'off'.

Pressing & holding EDIT brings up a menu where you can select three alternative views for the EDIT page:

```

Step Trg Layer 303          Step Datawheel: Random  Random  Euclid
View View View View      Select Scroll  Confis  Generator Generator

```

1. Step View (the default) shows 16 steps at a time, but only one parameter layer (in the LCDs) and one trigger layer (in the states of the LEDs below the LCDs):

```

G1T1  Def. Chn 1  PA:Note  TA:Gate Step 1  G#1  Vel:127 Len: 75%  NoCat
G#1  ---- A#1  ---- G#1  ---- A#1  ---- G#1  ---- A#1  ---- G#1  A#1  A#1

```

2. Trigger View shows only one step at a time, but seven trigger layers and up to 8 parameter layers for the selected step:

```

Step Gate Acc. Roll Glide Skip R.G  R.V Note Vel. Len. Roll Note Note Note Note
 1  *  o  o  o  o  o  o  C-3 100 75% ---- E-3 G-3 ---- ----

```

3. Layer View shows only one step at a time: the gate trigger layer and up to 14 parameter layers for the selected step:

```

Step Gate Note Vel. Len. Roll Note Note Note Note Note Note Note Note Note
 1  *  C-3 100 75% ---- E-3 G-3 ---- ---- ---- ---- ---- ----

```

4. 303 View shows a variety of settings, mimicing Roland TB-303's sequencer:

```

Step Gate Acc. Glide Oct. Key Vel. Prob CC  CC  CC  CC  CC  CC  CC  CC
 1  *  o  o  3  C 100 100% 64 64 64 64 64 64 64 64

```

4.2.1. Copy, paste, duplicate, quick-export/import

Besides just entering/recording notes and other data in a track, you can also copy, paste and duplicate the data in each track. Copy and paste have their dedicated buttons on the frontpanel, while the rest of the editing options can be found by pressing UTILITY. Quick-export/import uses the MENU + COPY/PASTE button combination.

```

Trk.      Utility Functions          Quick Menu Change
G1T1 Copy Paste Clr Move Scrl Rand Undo Save Jam  Opt. PMte Disk Mute UnMte

```

Pressing COPY copies the active track into the buffer, and it can then be pasted into another track; you can change sessions in between copying and pasting if you like. Note that COPY copies the *set length* (from the LENGTH page) of the track. For example, if the set length is 16/128, pressing COPY will copy only the first 16 steps into the buffer. Also, note that if track set length is e.g. 8, the COPY function will copy the section of 8 steps where the cursor position happens to be. For example, if the cursor is in step 1, COPY will copy the first 8 steps (probably what you intend most of the time), but if the cursor is in step 12, COPY will copy steps 8-16 instead.

It is possible to copy and paste an individual parameter layer. On the source track, choose the parameter layer you want to copy, and press COPY. Then go to the target track and select the

parameter layer where you want to paste the individual parameter layer. Press SELECT + PASTE to copy the parameter layer into the active parameter layer. This will overwrite the active parameter layer, including its type.

Clearing individual parameter layers works the same way: SELECT + CLEAR will clear only the active parameter layer.

It is also possible to perform these operations on a Drum type track's drum instrument layers. However, it is not possible to copy, paste and clear "normal" individual trigger layers similarly.

Multiple tracks cannot be copied at once. If several tracks are selected, only the one visible in the LCDs (the active track) is copied.

However, if you *press & hold* COPY, you can copy a selected *section* of the active track. GP knobs select the start and end position of the section (indicated by > < angle brackets). A knob at the starting position (or to the left of it) selects the start of the section (">"), and a knob to the right of the starting position selects the end of the section ("<"). The top row of the left LCD shows the steps to be copied (e.g. "COPY S1-12" for copying steps 1-12). Releasing the COPY button copies the selected section into the buffer.

Pressing PASTE once pastes the copied track from the buffer into the beginning of the track, overwriting whatever was there. If the copied track was 16/128 steps long and you paste it into a track that is 32/128 steps long, only the first 16 steps will be overwritten.

However, if you *press & hold* PASTE, you can offset the beginning point of the operation with the GP knobs. The > - - < angle brackets indicate the location. If the pasted section is too short to cover all the content in the target track, e.g. pasting a 16 step section into a 24 step track, 8 steps of the target track will not be overwritten. (Which 8 steps won't be overwritten depends on your paste operation's starting point.)

In UTILITY Opt. (Option #8) you can change whether the paste function pastes the whole track (Complete Track), or just the trigger layer and parameter layer values in the steps (Only Steps). (The same option controls the behaviour of the clear function as well.) 'Only steps' is probably the better setting for normal use. Complete track pastes/clears all track settings, i.e. length, mode, in a word, all configuration. The exceptions are MIDI channel and port, which will not be overwritten. If the target track is of the same type (Note, Chord, CC, Drum) as the source track, pasting a complete track won't initialise the target track to change its combination of maximum length or the number of parameter and trigger layers. But if the target track is of a different type than the source track, the target track's type will change, and it will become an exact copy of the source track. For example, pasting a 16/128 Note track into a 64/64 CC track will turn the latter into a 16/128 Note track.

It is possible to duplicate a track by pressing & holding COPY and then pressing PASTE. If your track is 16/128 steps long, this operation will copy the first 16 steps of the track and paste them immediately after it, starting from step 17. The track length is changed automatically to match the new duplicated length (e.g. from 16/128 to 32/128). The cursor position will jump to the beginning of the newly duplicated sequence (e.g. step 17). You won't be able to duplicate a track that is too long to be duplicated (e.g. a track with a length of 64/128 can be duplicated once, but a track with a length of 128/128 cannot be duplicated.)

One or several tracks can also be quick-exported and imported. Multiple tracks within a single group can be selected with the track selection buttons, or any combination of tracks on the Track Selection page (available only as an F1-F4 button or as a saved bookmarks; see Appendices 1 and 2), and then

exported with MENU + COPY. This will copy all data in the track(s), including settings, into the PRESETS folder, i.e. they're not session dependent. This means that you can have a maximum of sixteen tracks exported this way at any given time for all your sessions. The file names are of the form COPYx(.V4T), where x is the relative number of the quick-exported track (1-16). Relative means that if, for example, you have selected tracks G2T2, G2T3 and G2T4 and then quick-export them with MENU + COPY, they will be called COPY1, COPY2 and COPY3, even though their "absolute" track numbers are 6, 7 and 8.

One, some or all of the copied tracks can be pasted with MENU + PASTE, which will paste only so many tracks as have been selected with the track selection buttons. The pasting follows the same relative pattern as the copying, so that COPY1 will be pasted to the first selected track, regardless of its "absolute" track number.

Note that if you first copy four tracks this way, and later copy two tracks, the first two of the older tracks (COPY1 and COPY2) will be overwritten, but the latter two of the older tracks (COPY3 and COPY4) will remain. If you then paste four tracks, you will get two "new" tracks and two "old" tracks.

Tracks exported with MENU + COPY can also be imported one by one from the EVENT page's PRESETS menu (GPB14-15). Currently there is no way to delete files in the presets folder in the sequencer; you have to do delete them manually from the SD card on your computer.

4.2.2. Clear, move, scroll, undo

Clear has a dedicated button on the frontpanel, while move, scroll and undo can be found by pressing UTILITY.

CLEAR clears all layers of all steps in the selected track, even if they're beyond the track's set length. Thus, if your track is 16/128 steps long, CLEAR will clear also the steps 17-128. In UTILITY Opt. (Option #8) you can change whether the clear function clears (i.e. resets) all track parameters (Complete Track), or just the steps (Only steps).

Even 'Complete Track' spares MIDI channel and port settings from being overwritten, but settings such as set length, divider value, FX settings etc. are reset to default values. 'Only steps' is probably the better setting for normal use.

Move allows you to move *individual steps* to another position with the GP knobs. When you press & hold 'Move', the screen switches to the EDIT page, and you can grab an individual step by turning the knob below it, and then move it to another location if you keep turning the knob one way or the other. Releasing the GP button will write the moved step into the new location, overwriting whatever was there previously.

Scroll allows you to move *sections of steps* with the knobs. When you press & hold 'Scroll', the screen switches to the EDIT page, and you can use a GP knob to grab a section of steps, so that the steps to the right of the knob (including the one above the knob) will be moved together, while the ones to the left will stay where they are. Releasing the GP button writes the moved steps into the new location, overwriting whatever was there previously.

Undo cancels the latest paste, clear, move and scroll operation. Note that if your MBSEQv4 is using an LPC1769 core, the undo function is disabled since firmware 4.089 because of memory issues! In other

words, the undo function works only with STM32F4 based MBSEQv4.

4.2.3. Using FAST and ALL buttons

The FAST and ALL buttons are located on the left side of the frontpanel, bottom row. They both have indicator LEDs to show whether the function is 'on' or 'off'.

Using the FAST button allows you to change a value with the knobs faster. The normal setting is useful for narrow value ranges and/or detailed changes, while FAST is useful for fast changes on a wide value range. Note that in some contexts, e.g. when editing velocity values, the FAST function is activated automatically. However, you can always switch it 'on' and 'off', according to your preference.

FAST and ALL buttons can be set to 'toggle' or 'momentary' in the HW setup file (see Appendix 1). The default setting for both buttons is 'toggle'.

Using the ALL button allows you to edit multiple values with just one knob in three ways. First, with the ALL function 'on', turning the knob in the *present cursor position* will cause the values for all steps to change at the same time, so that each step will be adjusted *relative to its original value*. For example, the original velocity value 50 in one step will advance to 70, while the original velocity value 100 in another step will advance to 120. It's irrelevant with knob you turn, as long as it's at the present cursor position.

Second, if you move any knob *other than the one in the current cursor position*, the sequencer will generate a descending or ascending *ramp* between the present cursor position and the knob you turn. This way you can generate e.g. velocity ramps easily.

Third, when the ALL function is 'off', *pressing & holding* the ALL button and turning the knob in the *present cursor position*, the values for all steps will *jump to the same value* as the step below which you're turning the knob. As you keep turning, the values for all steps will change at the same time, to the same value. If the ALL function is 'on', pressing & holding will turn the function 'off'. You have to have the ALL function turned 'off' before pressing & holding it for the third edit option.

By default the ALL function affects all steps, but this can be changed with the GP buttons when the ALL mode is on. When the ALL mode is on, the step LEDs start blinking to indicate a special function in the ALL mode. A blinking LED below a step means that the step will be affected by the ALL function; by pressing a GP button under a step you can turn the ALL mode 'off' for that step, indicated by an unlit LED. These changes can be made on the Step Select page as well: press & hold the EDIT button and press GPB8 to enter the page. "*" indicates that the step will be affected by the ALL function, "o" indicates that it will not be affected.

```
Select the steps which should be controlled by the ALL function:  
* * o o * * o o * * o o * * o o
```

If you have recorded a steady rhythm with Step Recording mode and increment setting +2 (i.e. 8th notes, every second step), you can first adjust the length of all the steps with the ALL function on for all steps, then turn half of the steps off for the ALL function so that they're not affected, and then turn a knob to adjust the length of only the "empty" steps so that the

notes will not glide into each other.

5. Working with patterns and songs

5.1. Saving a pattern

When working with several patterns and in song mode, it is important to save often so as not to lose by accident the changes you've made to the parameter and trigger layers and other settings of the four tracks in a pattern. MBSEQv4 will not save anything automatically (every five minutes or whatever), but instead you have to *choose* to save the changes yourself.

The primary way in which you'll lose your changes is bound up with *switching patterns*. Switching from an active pattern without saving it first will mean losing the changes you made to it since the last save.

When you switch to another pattern *within a group* – from 1:A1 to 1:A2, for example – you will lose the changes made to the track you are switching from – e.g. 1:A1 – unless you explicitly save them first. The unsaved changes in the active patterns of the *other groups* won't be affected (they're not being switched, after all).

However, starting the sequencer in song mode – either by pressing PLAY or automatically with the Jam page function AStart – will erase the unsaved changes in the active patterns of *all* groups. But once the sequencer is running in song mode, you can make changes to a pattern and not lose them, on the condition that the pattern in question doesn't get switched to another one during the song. If it does get switched, that is the moment you'll lose your unsaved changes.

You can choose to save only one pattern, or to save all active patterns. A single pattern can be saved with MENU + SAVE (GPB14). The source pattern to be saved is always one of the four active patterns (each group has one active pattern). With GPK1-4 you can choose the source group whose active pattern you want to save, and with GPK6 you can choose the target bank to save the pattern into. Finally, with GPK7 you can choose which location within the selected bank the pattern is to be saved into. There are 64 locations per bank to choose from (from A1-A8 to H1-H8).

```
Grp. Save Pattern      to Target  Category: NoCat  Label: <Pattern A1>
G1 <Track 1- 4>/1:A1 ----> 1:A1  SAVE
```

In the right LCD you can see which locations are free and which ones already have saved content in them. If the location is free, the entry for the location is “- - - - <empty>”. If something has already been saved in the location, even if you haven't given the previously saved pattern a name (like with the 'Save All' function, see below), the entry for the location is “- - - - Unnamed”.

When saving individual patterns with MENU + SAVE, you get a chance to give the pattern a category and a label. The label could be named for the pattern's function in the song structure (“Intro”, “Bridge”, “2nd Verse”, “VrseVariant3” etc.) and the category could be e.g. the synth you're playing the pattern with, or the synth patch, or whatever helps you memorise the function of the pattern.

If you want to save all active patterns at once, press EXIT until you arrive on the main page, and then press GPB10 for 'Save'. This saves all the active patterns (and in fact the whole session). This way you won't get to give any categories or labels to the patterns, but instead they will be saved as “- - - -

Unnamed", or under the name you have given them when saving them individually earlier. You can also assign one of the F1-F4 buttons (right side of the frontpanel) to for a quick 'Save All' function (see Appendix 1).

```
MIDIbox SEQ V4.091      1.  1.  0 /SESSION/20100309      120.0 BPM
Edit      Mute Tracks      Open Save SaveAs New Delete      Info
```

5.2. Phrase Mode and Song Mode

In phrase mode you can build up to four active patterns (one in each group) and keep editing and testing them, alternating between manually starting and stopping the sequencer until you're happy with the result. In phrase mode the sequencer will keep playing the four active patterns over and over, and any pattern switch must be done manually on the PATTERN page. This also means that unless you actively, on your own initiative, switch to another pattern, starting the sequencer in phrase mode will *not* erase the changes you've made since the last save.

The phrase mode is suitable for a complete performance as well. If you have your patterns ready and saved, you can start the sequencer in phrase mode with four initial patterns, and then change the patterns live on the PATTERN page or the SONG page (even if you're not in song mode). Pattern changes like this can be instantaneous or timed, so that pattern change will be considered only at those times when the set number of steps has been played (e.g. every 8th step, or every 16th step). This is controlled with the Option page (UTILITY Opt.) settings #2 and #3 ('Pattern Change Synchronisation'). Option #2 sets the number of steps that have to play before a pattern change is considered, and option #3 enables/disables option #2.

You have pattern 1:A1 whose tracks are 16 steps long, and you set option #2 to 8 steps. If you press PLAY (in phrase mode) and don't do anything, the pattern will play 16 steps over and over (because that's the length of the tracks). If you turn a knob on the PATTERN page or SONG page to switch to pattern 1:A2 when the sequencer is running at step 3, the sequencer will play 5 more steps before it switches to 1:A2, because 3 + 5 = 8, and you've set the sequencer to allow pattern change only after every 8 steps. If you switch to 1:A2 when the sequencer is running at step 12, the sequencer will play four more steps before switching to 1:A2.

If you set the number high (e.g. to 64), you can give yourself plenty of time to scroll through the patterns you have available before the switch actually takes place.

In song mode you can chain the patterns you've made into a predetermined sequence of four parallel patterns. In addition to just putting the bundles of four patterns one after the other, you can also use song position operations to effect loops, mutes, tempo changes etc. (For details see section 5.2.2.)

In song mode you must remember to save the pattern(s) before starting the sequencer, if you don't want to lose the changes you've made, because in song mode starting the sequencer *will* erase the changes made since the last save.

You can check whether you're in Song or Phrase mode by pressing SONG. On the right LCD (top row) you can see either "Phrase Mode" or "Song Mode". The mode can be changed with GPK13-14. You can also press & hold the SONG button, which will bring up the song page utility menu. While you

keep pressing the SONG button, you can alternate between song and phrase modes by pressing GPB9-10.

In addition to the information of the LCD, the LED above the SONG button indicates the mode, no matter which page you're on: if it's lit, it's song mode, and if it's unlit, it's phrase mode. When you're on the SONG page, the LED above the SONG button will flicker if you're in Phrase mode, and it will be solid when you're in Song mode.

5.2.1. PATTERN page

Patterns can be selected on the PATTERN page, e.g. for editing and playing in phrase mode. On the page you can see the four groups, each of which has one active pattern in it, and a small velocity bar for each track. The pattern categories and labels will also be displayed on this page, whether you've explicitly named them or not (in which case you'll see "NoCat" and "Unnamed"). The first thing to pay attention to is what has already been mentioned several times: don't change patterns unless you have saved the active one in the group where you're about to switch to another pattern, unless you don't mind that the changes in the active pattern since the last save are lost!

```
G1: Monty Intro      G2: Monty Beats 1  G3: Bassline Intro  G4: Transposer off
>>> MBSID 5:C1  _ _ _  MBSID 6:C1  _ _ MM  MBSID 7:C1  _ _ M_  LoopB 8:C1  _ _ _ _
```

If you want to change the pattern bank, in all cases you have to use the GP knobs 3, 7, 11, and 15 to do it. For selecting individual patterns in the banks, there are two ways. Either you can use the GP knobs 4, 8, 12, and 16 to select a pattern within the selected bank, or you can use the GP buttons 1-8 to choose the pattern section A-H and the GP buttons 9-16 to choose the actual pattern 1-8 within the sections A-H.

Also, on the PATTERN page the group and track selection buttons (on the upper left of the frontpanel) have a special function: you can use them to select the group where you want to change a pattern. Group/track selection button 1 selects the first group, button 2 the second group etc. For a fully equipped frontpanel, this is probably not necessary though, because you can just turn a GP knob to select a pattern within any group, without the need to use the group/track selection buttons to select a group for switching first.

5.2.2. Chaining patterns into a song

Patterns can be chained into songs on the SONG page. One session can have a maximum of 256 patterns (64 patterns per bank), which can be combined into a maximum of 64 songs. Four patterns are playing in parallel. If you don't want to play anything in one or more groups, have them play an empty pattern (like H8 or other "far-away" pattern), or use a song operation to mute them.

```
Song Pos Actn G1 G2 G3 G4 Sel. Song Mode S# 1 Pos A1.-- Loop --/ 1
  1   A2  x 16 5:C1 6:C1 7:C1 8:C1 Pat 5:C1  _ _ _ 6:C1  _ _ MM 7:C1  _ _ M_ 8:C1  _ _ _ _
```

Patterns are organised into a song by means of song positions. There is a maximum of 128 song positions (A1-P8) per song. They can be selected with either just GPK2, or, if your song is very long and/or has many song operations, you can quick-select the letter A-P with the GP buttons and only the

number with GPK2.

Each song position is either a command to play a pattern or perform an operation. A very simple song could be:

Pos	Actn	G1	G2	G3	G4
A1	Mutes	o***	oooo	oooo	oooo
A2	x2	1:A1	-:--	-:--	4:A1
A3	Mutes		ooo*	oooo	oooo
A4	x1	1:A2	-:--	-:--	-:--
A5	x1	1:A3	-:--	3:A1	4:A2
A6	Jump	□ Pos. A1			

This song starts by muting G1's tracks 2-4. ("o" = play, "*" = mute) in song position A1. Then the actual music begins in position A2 by playing patterns 1:A1 and 4:A1, and they will play twice (because Action is set to 'x2'). When a group has -:--, it means "repeat here whatever was done in the previous song position". However, even though the previous position for G2 and G3 set muting to "play all tracks", there hasn't been a pattern playing in this group previously, so muting or unmuting has no practical effect, hence nothing will be played in groups 2 and 3.

After the patterns in position A2 have played for the second time, the song will proceed to the next song position, A3, where there is an operation: some more tracks from G1 are unmuted. In the next position, A4, it's back to playing patterns again: the pattern in G1 is switched to 1:A2. Group 4 now has -:--, but because the previous song position was "play all tracks in this group" and there is a previous song position where 4:A1 was played, 4:A1 will get played here too. Action for position A4 is set to 'x1' ("play once"), so after the patterns finish, the song proceeds to the next song position.

In position A5 Group 1 switches to a new pattern (1:A3), as does group 4 (4:A2). Also, now Group 3 starts playing a pattern, 3:A1. After they have played once, the song proceeds to the next song position, A6. There is an operation there, which causes the song to jump immediately to song position A1, i.e. the beginning of the song. Everything will go as before, but this time group 3 will be playing 3:A1 all the way from the beginning. This is because now there is a "previous song position" for the -:-- in G3 for song position A1, namely position A5 from the first iteration, where G3 was playing 3:A1.

The possible song operations are:

- **End.** Loops the previously played song position with patterns in it until the sequencer is stopped manually or another song position is selected with the GP buttons (turning GPK2 on the SONG page won't switch patterns). This means you can use 'End' also in the middle of a song, e.g. to jam over the looped song position as long as you like, and then press a GP button to continue with the preprogrammed song. As the GP buttons can only be used to select eight different song positions (A1, B1, C1 etc., up to P1), you have to make sure to start the "post-jamming" sequences at those song positions; otherwise they won't be selectable. Also, make sure that the "-:--" entries are not messing up which pattern gets played after manual song position change! Another option is to select the next song position with GPK2 and then press PLAY to instantly jump to the selected song position.
- **x1-x16.** plays the current song position 1-16 times before proceeding to the next song position.
- **Jump Pos.** Jump to the specified song position.
- **Jump Song.** Jump to the beginning of the specified song.
- **Mixer.** Dump the specified mixer map. (For details on mixer maps, see section 6.5.)
- **Tempo.** Change to the specified tempo (BPM), and make it gradually during the given time (Ramp). Ramp of zero seconds means immediate change to the new tempo.

- **Mutes.** Mute/unmute the specified tracks. “o” signifies an unmuted track, “*” signifies a muted track. You can either scroll a GP knob under the entry for all the possible combinations for each group, or press a Group/Track button and then use the 16 GP buttons to switch mutes on/off for individual tracks (GPB1-4 control mutes in tracks 1-4 etc.); while the action is “Mutes”, the GP LEDs indicate whether a track is to be muted or not).
- **G.T.** Set a track as Guide Track (for details of Guide Track, see section 5.5.).
- **UnMte.** Unmute all tracks and layers.

On the SONG page you can see just the numerical names of the patterns, and when your song has several patterns, it can be difficult to remember which pattern is which; was 1:A5 my second verse variation pattern, or was it 1:A8? Here it's helpful to use the PATTERN page to build the song positions. On the PATTERN page you can select the four patterns that you need and see their names while you do the selection. (Naturally this requires that you've given your patterns a category and a label when you've saved them individually earlier.) After selecting the desired pattern for each group, you can press & hold SONG to select 'Take Over Patterns' with GPB13-14. This will copy the four selected patterns into the current song position on the SONG page, overwriting what was previously in that position. Note that 'Take over Patterns' doesn't save the patterns!

Remember once again that changing patterns on the PATTERN page will erase any unsaved changes!

Pressing & holding the SONG button on the SONG page shows a utility menu in the left LCD with commands to edit song positions: you can copy, paste, clear, and delete a position, or insert a new one *before* the current position. Also, COPY, PASTE and CLEAR buttons have changed functions on the SONG page. Instead of copying, pasting and clearing the active track, they perform the operation on the current *song position*.

Song	Pos	Utility Functions				Phrase	TakeOver	Save&Take	
1	A1	Copy	Paste	Clr	Ins.	Del.	Mode	Patterns	Over Ptns.

If you're in Song mode, pressing & holding the SONG button shows an extra entry on the right display: Guide Track. (See section 5.5.)

5.2.3. Save & Take over Patterns

There's another function available on the SONG page while pressing & holding the SONG (or SELECT) button: 'Save & Take over Patterns'. The function is more than a little different from the 'Take over Patterns' function despite the similar name.

Here's how 'Save & Take over Patterns' can be utilised in making songs. When you create a new Session, you start with the four initial patterns 1:A1, 2:A1, 3:A1 and 4:A1. You change the track settings to your liking and punch in some notes. Once you have something that you like, you can save all four patterns and automatically make song position entries for them by using the 'Save & Take over Patterns' (=S&ToP).

After selecting 'S&ToP', you now get a chance to select one of 16 slots (A-P). These letters refer to song positions (available on the SONG page, GPK2), of which there are 128 (from A1-A8 to P1-P8). Each letter might have an asterisk next to it, which means something has already been 'S&ToP'd into that slot previously. You may overwrite it if you wish by selecting it again.

Choosing one of the slots will not only save the active patterns (so that you don't have to save them

manually), but will also create four entries in the song position list, based on the current setup. The four entries are: current mutes, mixer map settings, current patterns, jump to previous song position.

Let's assume you chose slot A (with GPB1). What you have now is entries in song positions A1, A2, A3 and A4:

Position A1: the state of your mutes when you activated 'S&ToP'. Position A2: command to dump the settings in Mixer Map 1. Position A3: command to play the set of patterns that was active when you activated 'S&ToP'. Position A4: command to jump back to Position A3 (i.e. loop the said set of patterns).

Pos	Actn	G1	G2	G3	G4
A1	Mutes	o***	o*o*	o***	**oo
A2	Mixer	Map 1			
A3	x1	1:A1	2:A1	3:A1	4:A1
A4	Jump	□ Pos. A3			

Had you chosen slot D, the entries would have been made into song positions D1, D2, D3 and D4 (with Mixer Map #4 settings) instead of A1, A2, A3 and A4 (with Mixer Map #1 settings). (This also means that the latter four entries grouped under each letter, e.g. A5, A6, A7 and A8, are left "empty", i.e. unaffected by the 'S&ToP' function.)

Whenever you come to the SONG page, the song position (Pos) entry is highlighted. (You can change which entry is highlighted by turning a GP knob, but Pos is the default when coming to the SONG page.) While Pos is highlighted, you can use the GP buttons to quick-select a song position. For example, if the current song position is A3, you can push GPB6 to switch to F1. The GP buttons allow for the direct selection of 16 positions, from A1 to P1 (the selected position is always the first one within the eight that are grouped under each letter).

Whether or not the switch to another song position is immediate or takes place only after the current Measure is finished depends on your settings on the Options page (UTIL → Opt., option 3/17).

In a nutshell: 'S&ToP' allows you to start with four patterns (e.g. 1:A1, 2:A1, 3:A1, 4:A1), jam to your heart's content, and when you have something you like, to save them quickly and have the song position entries made automatically. Then you can change to the PATTERN page, turn the knobs to change over to the next empty pattern set (e.g. 1:A2, 2:A2, 3:A2, 4:A2), to the next Mixer Map on the MIXER page, and keep jamming. Then you can 'S&ToP' again, and on and on, until you have several pattern sets. Now you can keep changing back and forth between the maximum of 16 pattern sets while on the SONG page with a single push of a GP button. Each pattern set might have each track full of stuff, but the set would start with lots of mutes, which you could then slowly unmute and build the current theme up before changing to another set with a GP button.

5.3. Copying Patterns

When working with multiple patterns and possibly complex song structures, it's often useful to be able to copy a pattern into another pattern slot for tweaking, either slightly or by changing one or two tracks in the pattern completely. You can do it the way that was already described in section 4.2.1., but there's another way. Press UTILITY □ Disk to enter the import/export page, and then press GPK1-2

to select either 'Import' or 'Export' under the 'Sessions' title.

On the Session import and export pages you can copy patterns, songs, mixer maps, grooves, track configurations and bookmarks from one session to another, or within the same session. (Scroll through the 'Type' options with GPK9–10.) Exporting means copying something *from the current session* to somewhere else, and importing means copying something *to the current session* from somewhere else. However, if you just want to copy something *within the same session* (such as patterns), it's irrelevant whether you use exporting or importing to do it; the one end of either is always the current session, and if you set the other end (source or destination session) to be the current session as well, they will lead to the same outcome.

In other words, if you want to use import or export to copy a pattern *within the same session*, you always select the current session on the left LCD. Use the knobs below the left LCD to scroll through the saved sessions and the GP buttons to choose the source/destination session. If you don't remember your current session's name, press EXIT until you reach the main page. The current session's name is displayed on the right LCD, top row.

In addition to session selection, you need to determine the source pattern in the source session and destination pattern in the target session, whether the source/target session is the current session or not. First make sure that the Type to be copied is 'Patterns', then use GPK11 to select the first pattern to be copied, and GPK12 to select the last one to be copied – this means you can copy several subsequent patterns in one go. Then turn GPK13–14 to select where you want to copy the selected patterns to. If you selected several patterns to be copied, the destination setting changes automatically to cover equal number of pattern slots. Confirm your selection with GPB15 ('IMPORT' or 'EXPORT').

If you have an idea for a song which has a recurring pattern structure and settings, you can copy the first “seed pattern” with the right settings into several other pattern slots (which otherwise would have the sequencer's default settings) like this: first, copy x:A1–x:A1 to x:A2–x:A2. Then copy x:A1–x:A2 to x:A3–x:A4, then x:A1–x:A4 to x:A5–x:A8, and so on.

If you want to copy just a single pattern at a time, you can use MENU + SAVE to copy the active pattern to another location. Using this option also allows you to name the new pattern as you copy it, something that's not possible with the mass copy option above.

5.4. Measure

In sheet music, a measure (or bar) is a delimited sequence with a defined length in beats. A common measure is 4/4, which means its length is four quarter notes (which, timewise, is as long as eight 8th notes, or sixteen 16th notes). On MBSEQv4 the length of measure is set in the Options menu (UTILITY Opt., Option #1, 'Steps per Measure'). The length of measure is 16 by default. Measure length is given in 16th notes, so the default length is sixteen 16th notes (i.e. the same as four quarter notes etc.), and that is probably what you want most of the time for no-nonsense rhythm music.

Measure is relative to the tempo (BPM), and they are always in sync, no matter what the divider settings etc. of individual tracks are. The bind between measure length and tempo is reflected in the pulse of the LED above the datawheel. With measure set to 16, the LED flashes every quarter note, but if you set measure to 17, the LED will flash every quarter note *and* every time the measure starts a new countdown from 1.

The measure setting affects three things:

1. How the metronome sounds. (The Metronome settings can be found in UTILITY → Opt., Option #12.) The metronome settings allow you to set a distinctive sound for the first beat of each measure as opposed to the the other beats;
2. The song position displayed on the SONG page (left LCD, top row). However, this is overridden by the Guide Track function in song mode (see sections 5.4.2. and 5.5.); and, most importantly,
3. The Sync to Measure function, which can be set 'on' or 'off' on each track's DIVIDER page (default: 'off').

Whether or not any track is sync'd to measure, every time you start the sequencer, it will start keeping track of the measure count. If the length of measure is set to 16 steps (UTILITY □ Opt., Option #1), the sequencer will start counting from 1 to 16, and after reaching the end of the 16th step, it will be *reset*, i.e. started from 1 again. It's like you yourself might be counting quarter notes: one two three four, one two three four, etc. in a steady rhythm, with the difference that measure is counting 16th notes. This recurring count continues until the sequencer is stopped.

Sync'ing a track to measure means that the track's restarting will be bound to the restarting of the measure count: when the measure has counted its last step, it will be reset to the beginning, and any track that is sync'd to measure, will be reset as well, i.e. started from the beginning.

5.4.1. Sync to Measure in phrase mode

By default the tracks are not sync'd to measure, so the setting has to be enabled separately for each track on the DIVIDER page (GPK5-7 for 'yes' or 'no'). If no track is sync'd to measure, they all will run independently of each other, and are relative only to the tempo setting.

Fiddling with the divider/timebase settings on the DIVIDER page can bring the independent tracks completely out of sync with each other. Sometimes that's just what you want, but if you have a number of tracks that are out of sync and you want them sync'd, this can be done with setting 'Sync to Measure' to 'yes' on the DIVIDER page. If measure length is 16 steps, every track that is sync'd to measure will be reset and started from the beginning at the time when the measure count resets back to the beginning, no matter how long the tracks are and where their relative cursor position is. Tracks that are shorter than measure length will repeat on their own until the measure count is reset, and the shorter-than-measure tracks will reset at that point, just like any other track that is sync'd to measure.

Let's say measure length is 16 steps, a track's length is 6 steps, and the track is sync'd to measure. This track will repeat twice on its own, because two times 6 is 12 steps, i.e. shorter than 16 steps, which is the length of the measure. However, during the third iteration of the track, the measure is reset before the track can reach its end; the track is reset together with the measure count. Thus, this shorter-than-measure track will play two times and four steps before it is reset ($6 + 6 + 4 = 16$). A track that is longer than measure will be cut short, if it is sync'd to measure.

Naturally sync'ing to measure doesn't guarantee that the sync'd tracks will be in sync *all the time*, only that they will be simultaneously *started* from the beginning every time measure count starts

from the beginning. In other words, each track is sync'd to the *measure*, not to each other. Each sync'd track will get the reset command at the same time, but after the reset they will go they own separate ways again, according to their individual length and divider settings, until measure reset forces them to start from the beginning again. This allows you to effect repeating patterns of asynchronous play.

In the example below, measure is set to 6, and tracks 1-4 are sync'd to measure. Tracks 1 and 2 will be cut short because they're longer than measure, and tracks 3 and 4 will repeat part of their content before measure count restart resets them.

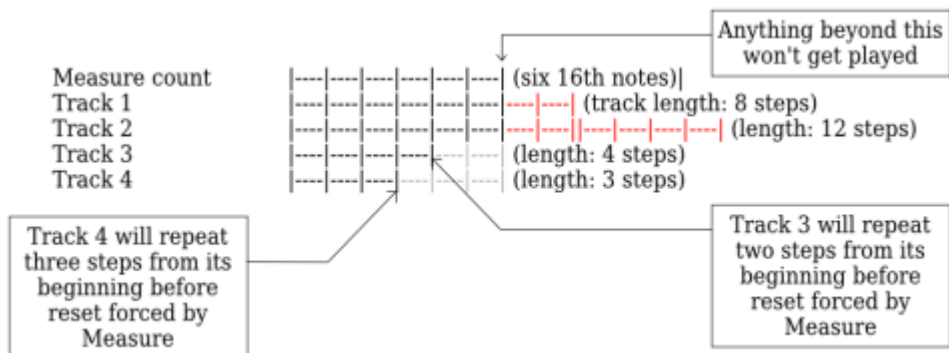

It's also possible to sync tracks to measure manually on the MENU + MANUAL page. Pressing SELECT on this page will sync the selected tracks to measure. Tracks can be selected either with the group and track selection buttons (top left of the frontpanel) or on the Track Selection page (for details, see section 5.6.).

5.4.2 Sync to Measure in song mode

The 'Sync to Measure' setting is not the recommended way to sync tracks in song mode. Instead, in song mode the recommended way to determine the change to the next song position (or to the next loop within the same song position) is the Guide Track function (see section 5.5.). In song mode, Guide Track is on by default (set to G1T1), and will override any sync to measure settings on the tracks' DIVIDER pages.

It is possible to disable the Guide Track function by setting it to "—". However, as by default no track is sync'd to measure, this will result in behaviour that is unlikely to be as useful as the more predictable ways that are available ('Guide Track' in song mode, 'Sync to Measure' in phrase mode). Try at your own risk!

5.5. Guide Track

Pressing & holding the SONG button brings up a menu where you can alternate between the song

mode and phrase mode (GPB9 or GPK9). In song mode the Guide Track setting is on the right display, and it can be used to choose a single track which the sequencer will follow as a master track, as far as length and changing to another pattern are concerned. (You can change the Guide Track setting in mid-song as well, it's one of possible song position operations on the SONG page; see section 5.2.2.) The Guide Track function is only available in song mode, and won't even be visible or selectable in phrase mode.

Song	Pos	Utility Functions	Song	GuideTrack	TakeOver	Save&Take
1	A1	Copy Paste Clr Ins. Del.	Mode	G1T1	Patterns	Over Ptns.

In phrase mode, all tracks are running independently of each other, and share only the tempo. For song mode, this will not do. The point of the song mode is to chain several patterns together and switch them in an automated way, and you have to determine when to switch to another pattern, even if the tracks have different lengths and end at different times. Guide Track will allow you to determine which track (G1T1-G4T4) triggers the change to the next song position (or to the next loop within the same song position).

By default, Guide Track is 'on', and set to G1T1. If the Guide Track function is active (i.e. has some other value than “- -”), it will make pattern change dependent on the track set as the guide track. The track selected as the guiding track will allow pattern change only when *it* reaches its end. Shorter tracks will loop back to their beginning and keep playing over and over until the guiding track reaches its end, and if that happens before the other tracks have finished, they will be terminated mid-way. Tracks longer than the guide track will be terminated mid-way as well.

So, the selected guide track will run to its end, and when it reaches the end, the sequencer switches to the next song position, regardless of where the other, non-guide tracks are at. All the tracks of the next pattern to be played are started from the beginning.

The Guide Track function overrides any sync to measure settings (made on the DIVIDER page for each track), and will also override the SONG page song position counter (right LCD, top row). Instead of following Measure (UTILITY Opt., Option #1), the counter will follow the length of the track selected as guide track.

For easily predictable results, the track set as Guide Track should have its divider value set to “16 (normal)” (the default setting) on the track's DIVIDER page. Smaller divider values (i.e. faster tracks) will result in repeating the guiding track wholly or in part, and bigger divider values (i.e. slower tracks) will result in a truncated guiding track.

If the Guide Track function is disabled (i.e. set to “—”), the sequencer will fall back to measure. However, as no tracks are sync'd to measure by default, disabling Guide Track will result in behaviour that is unlikely to be as useful as the more predictable ways that are available ('Guide Track' in song mode, 'Sync to Measure' in phrase mode). Try at your own risk!

5.6. Track selection, Solo and Mute

Track selection is possible by two means. First, you can select several tracks *within the same group* by pressing the track selection buttons (on the upper left of the frontpanel). If you press & hold one track selection button, you can select and unselect other tracks within the selected group as long as you keep pressing & holding one button (it doesn't have to be the first you pressed). It is not possible

to select tracks in several groups with the group and track selection buttons.

If you need to select tracks in several groups, you have to use the Track Selection page. The page is available only as a customised F1-F4 button (see Appendix 1) or as a saved bookmark (see Appendix 2). On the track selection page you can press & hold a GP button, and while you keep pressing it, you can select or unselect any combination of tracks. The selected tracks are indicated with > < angle brackets.

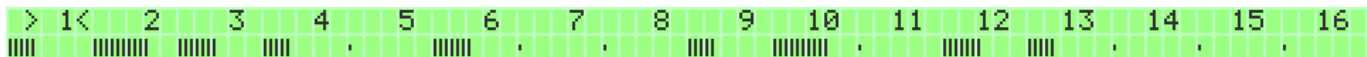

The solo mode is activated by pressing the SOLO button. When solo mode is active, only the selected track(s) will be played, and all the others muted. It is possible to select one or more tracks either with the track selection buttons, or by using the track selection page.

The mute page can be accessed by pressing the MUTE button. While on the page, you can press the GP buttons to toggle mutes for each track in any combination you like. The mutes and unmutes set on this page can also be sync'd to measure in UTILITY □ Opt. □ Option #6 (sync mutes) and #7 (sync unmutes). If sync mutes/unmutes to measure is activated, muting a channel shows a measure countdown to when the next muting or unmuting is going to happen. Note that if your tracks are not sync'd to measure, but the mutes/unmutes are, the mutes/unmutes might not happen predictably.

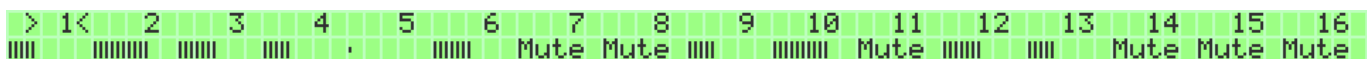

While on the MUTE page, you can press & hold SELECT, and choose any number of tracks with the GP buttons. The selected tracks will be muted simultaneously when you release SELECT.

Mutes from sources *other than the MUTE page* (from bookmarks, with CCs etc.) are not affected by options #6 and #7, but happen instantaneously. Sync'ing mutes to measure works along the same principles as sync'ing a track to measure. See section 5.4. on Measure for more information.

It is possible to mute individual parameter layers for Note, Chord or CC type tracks by pressing & holding the MUTE button and selecting layers with the GP buttons. With Drum tracks, you can mute individual drum instrument layers similarly.

While on the MUTE page, the ALL and FAST buttons have special functions. First, if you have sync'd mutes/unmutes to measure with Options #6 and/or #7, activating the FAST function allows you to bypass this temporarily. While the FAST function is active, mutes and unmutes happen instantaneously, regardless of mute/unmute sync settings. Second, you can activate the ALL function to bring up a menu for quick muting and unmuting options (which happen instantly). The options are:

1. Mute all tracks;
2. Mute the active track's layers;
3. Mute all tracks and all layers;
4. Unmute all tracks;
5. Unmute the active track's layers; and
6. Unmute all tracks and all layers.

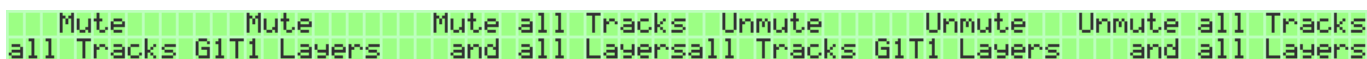

Note that unmuting a *track* and unmuting a *track's layers* are different operations. Muting a *track* is an all-or-nothing operation, while muted *layers* can be unmuted one by one by pressing & holding the MUTE button and selecting layers with the GP buttons.

If a complete track is muted, the track's velocity bar on the MUTE page is replaced by the text 'Mute'. However, if one or more of the track's *layers* are muted, the track entry's *upper row* on the MUTE page will have a small "m" next to the track's original number to denote that even though the track is not muted, one or more of its layers are.

A quick muting and unmuting of all tracks (instantly) is also available on the UTILITY page (GPB15 and GPB16).

Finally, the bookmark page (see Appendix 2) can be used to effect customised mutes/unmutes of any combination of tracks with one button. Mutes and unmutes from bookmarks happen instantaneously, regardless of any sync settings.

6. Some advanced features

6.1. Using a bus to control a track

The MBSEQv4 has four buses that can be used to send MIDI data to other tracks. A track sending on a bus can be used to control the behaviour of another track over the bus for effecting arpeggios and transposing notes. The controlling track is called *the sending track* (because it sends data on a bus), and the controlled track the *receiving track* (because it listens to a bus for data).

First, it is possible to use the sending track's *note data* to *transpose* the notes of a receiving track. A receiving track in Transposer mode accepts only one note as input. You can send chord data as well – either as multiple notes or as chord parameter layer entry – but only the last note layer or chord note will be accepted.

Transpose is relative. This means that if the sending track is controlling two tracks over the same bus, and the first receiving track has just C-3 notes in it, and the second receiving track has only E-3 notes in it, changing the sending track's note from C-2 to C#2 will transpose the receiving tracks' notes half a step upwards – from C-3 to C#3 on the first track, and from E-3 to D-3 on the second track.

Second, it is possible to use the *chord data* of the sending track to control the *arpeggios* on a receiving track. The chord data can be either chord parameter layer data, or it can be data from multiple simultaneous note layers. For example, if the sending track's chord sequence is C-Am-F-G, played each quarter note (either as chord track or note track data), the arpeggio patterns on the receiving track will always include only the notes that the current chord on the sending track contains. In other words, the arpeggio *patterns* are determined by the receiving track (the arpeggiator track), but the *notes* in the patterns are determined by the chords the sending track plays.

Whether the input is in chord or note layers, the arpeggiator takes the last four played notes as input. If you play more than four notes simultaneously, the earlier ones will drop out first. Hence, if you send five simultaneous notes in different note layers, the first note layer will be ignored, and if you send a chord layer chord that's more than four notes, only the last four notes of the chord will register.

In both cases (transpose notes or control arpeggios), instead of sending *track data* over a bus to control another track, you can use your *MIDI controller* over a bus to control a track in a similar manner, so that e.g. the chord you play on the keyboard will determine what the receiving track or tracks play. For this, see section 6.1.5. for details.

6.1.1. The MODE page

The central settings on the MODE page of each track pertain to tracks that are to be controlled by another track (or a MIDI controller) over a bus. These are: Mode (off, Normal, Transpose, Arpeggiator), Bus (1-4), Hold, and Sort.

Trk.	off	Transpose	Bus	Hold	Sort	Restart	ForceScale	Sustain
GI1	>Normal<	Arpeggiator	1	on	on	off	off	off

If the track mode is Transpose or Arpeggiator, and Hold is set to 'on', the sequencer will hold the last note(s) received on a 'T&A' bus *from a MIDI controller* (see section 4.1.1. for details). In other words, Hold will have no effect if the controlling data is coming in from a track. If Hold is set to 'off' and no keys are held on the MIDI controller, the track will play nothing. (However, if the Sustain setting is 'on', it *will* hold the previously played note(s) until something else is played.) Hold works in Transpose and Arpeggiator modes, but has no effect if track mode is 'Normal' (or 'off').

If the track mode is Arpeggiator, and Sort is set to 'on', it will sort the played notes into ascending order. The setting works only in Arpeggiator mode, and it makes sense to have this option 'on' for Arpeggiator mode, so that the Arpeggiator track notation stays more understandable. If Sort is set to 'off' in Arpeggiator mode, the Arpeggiator will play the notes in the *reverse* order to how they were played.

The 'Note' setting pertains to the Transposer mode. If the setting is 'First', the transposer will use the first note of the controlling chord, and if it's 'Last', it will use the last note of the controlling chord. While a single note is enough for the transposer, you might want to use the same controlling track to control both the transpose of a track and the arpeggiating of another track, and for the latter you need a chord.

If Sustain is set 'on', it will sustain the latest note or chord played on the track until another one is played or the sequencer is stopped. This is useful for tracks that play long notes or chords, so that you don't have to set each note's length individually. Sustain will have effect only on tracks that are sending to a physical output port (set on the EVENT page). In other words, it will have no effect on tracks sending on a bus.

If Restart is 'on', it will restart the track every time something new is played on it. This is mostly useful for tracks controlled with a MIDI controller over a T&A bus (see section 4.1.1.). In principle it works for normal tracks too, but the effect gained is better implemented with adjusting track LENGTH.

On Force To Scale, see section 6.2. for details.

6.1.2. Setting up sending and receiving tracks

In order to enable one track's control over another track via a bus, both the sending (controlling) track and the receiving (controlled) track need to be set up.

Except for the sent data, the sending track is set up in the same way, whether it's controlling the transpose or arpeggiator pattern of another track. To set up the sending track, press MENU + EVENT. On the EVENT page, the Port option (BPK6) controls which port the track is sending its data out on. Bus1-4 are among the selectable ports. The function of each of the four buses is set on the Jam

page's MIDI settings. There are two options: 'Jam' and 'T&A' (Transpose & Arpeggiator). In order to use a track to control another track's transpose or arpeggiator, it has to be sending over a bus that's set to 'T&A'. (For details, see section 4.1.1.)

If, on the sending track's EVENT page, you choose one of the buses as the port, the track will now be sending its data to that bus instead of a physical port (such as OUT1).

Note that the moment you switch the port setting to a bus on a track's EVENT page, the track will stop playing any synths directly, and can now do so only indirectly by controlling other tracks that have *their* port setting pointing to a physical port. If you want to audition what you've entered into the sending track before you have set up a receiving track, you have to adjust Port (and perhaps Chn.) settings accordingly.

The receiving track has to be set to listen to a bus. This is done on the receiving track's MODE page (MENU + MODE). By default each track is listening to Bus1. A track can have three modes: Normal (default), Transpose, and Arpeggiator (also, it can be set to 'off'). The mode is selected with GP buttons 2-5, and the selected mode is surrounded with > < angle brackets. The bus which this track is listening to is set with GPK8. The bus setting has no effect in Normal mode.

Transpose and Arpeggiator modes work differently, so each of them will have to be dealt with in turn.

6.1.3. Receiving track mode: Transposer

The sending track should send only a single note via a bus to the receiving track in Transpose mode. If several notes are sent, only the last one will register (the last note of the chord or the last note layer of many simultaneous note layers). The receiving track's notes will get transposed relative to the received note. This means that if the sending track is controlling two tracks over the same bus, and the first receiving track has just C-3 notes in it, and the second receiving track has only E-3 notes in it, changing the sending track's note from C-2 to C#2 will transpose the receiving tracks' notes half a step upwards - from C-3 to C#3 on the first track, and from E-3 to D-3 on the second track.

The receiving transpose track must be set to listen to the sending track's bus, and it has to have its mode changed to 'Transpose'. The track's mode is changed on the MODE page (MENU + MODE). In addition, the MIDI configuration page (available e.g. on the Jam page, GPB7) must have the bus in question set to the mode 'T&A'; naturally the other settings on the MIDI configuration page must allow the incoming messages through (for details see section 4.1.1.).

If there's no data on the sending track, the receiving Transpose track will simply play its contents as they are. If there are (subsequent, not simultaneous) notes on the sending track, they will control the receiving track's transpose. If the sending track's notes are erased after some playback, the receiving track will remember the note it received last, and will be controlled by the last played note until a new note is played. In a case like this you can revert back to the receiving track's own data on the Jam page's MIDI configuration settings: press 'Reset Stacks' to reset all note stacks.

See also the MODE page option Hold in section 6.1.1.

6.1.4. Receiving track mode: Arpeggiator

Unlike transposer tracks, an arpeggiator track accepts chord data, though also single notes will work in principle. Chords of up to four notes can be sent, either as chord parameter layer data or as simultaneous note layer data. Regardless of whether the input is in chord or note layers, the arpeggiator takes the last four played notes as input. If you play more than four chords simultaneously, the earlier ones will drop out first. Hence, if you send five simultaneous notes in different note layers, the first note layer will be ignored, and if you send a chord layer chord that's more than four notes, only the last four notes of the chord will register.

The receiving arpeggiator track must be set to listen to the sending track's bus, and it has to have its mode changed to 'Arpeggiator'. The track's mode is changed on the MODE page (MENU + MODE). In addition, the MIDI configuration page (available e.g. on the Jam page, GPB7) must have the bus in question set to the mode 'T&A'; naturally the other settings on the MIDI configuration page must allow the incoming messages through (for details see section 4.1.1.).

Selecting the Arpeggiator mode changes the EDIT page layout. Each note layer now follows a notation of two numbers with a minus or plus between them. The first number refers to the ordinal number of the notes of the sending track's chords, and the second number refers to the octave transpose of the note. The minus or plus in between denotes whether the given number of octaves is that much up or down. For example, if the controlling track is currently playing the chord Am with the notes A-2, C-3 and E-3 in it, occupying first, second and third note layers, and if the note entry for a step in the (receiving) Arpeggiator track is "2+1", it means this step will play the note in the *second* note layer of the sending track's currently playing chord - C-3 - transposed up by one octave, so the final note played by the Arpeggiator track for this step is C-4.

See also the options Hold and Sort in section 6.1.1.

6.1.5. Using a MIDI controller to control track transpose or arpeggio

In addition to controlling a track's transpose or arpeggio over a bus with another track, you can control a track's transpose or arpeggio with a MIDI controller over a bus.

On the MIDI configuration page (see section 4.1.1.), you need to set up a T&A bus to let through the messages you send on your MIDI controller, and then set the receiving track to listen to the bus your MIDI controller is sending data on. Make sure that no track is sending data on the same bus (check the port setting on each track's EVENT page). It will work in principle, but will likely lead to confusion.

For a transpose or arpeggiator track, you can use the Hold option on the MODE page to control whether the track will remember the last note you played on the MIDI controller (set Hold to 'on'), or whether the track will only play something when you press a key (set Hold to 'off'). The Hold setting has no effect except in Transpose and Arpeggiator modes.

For an arpeggiator track, you can use the Sort option on the MODE page to sort the notes you play into an ascending order. The Sort option has no effect except in Arpeggiator mode.

6.1.6. Sending internal CCs over a bus to control track settings

It is possible to send internal CC data over a bus to change a track's (or even the sequencer's) settings. To effect this, there's three settings you need to make on the sending track. First, on the sending track's EVENT page, select a CC parameter layer. Second, set the track's Port to send over Bus1. Bus1 can be set to 'Jam' or 'T&A', it makes no difference. Once the Port setting is set to 'Bus1', the CC layer options on the right LCD change to loopback CC control options, instead of normal CC options. For example, CC#49 now allows you to control another track's octave transpose.

The final setting you need to make is the *sending track's* Chn. setting (on the EVENT page) to determine which track you want to control with the internal CCs. Normally the Chn. setting has no effect if Port is set to a bus, but here it does. However, in this case the Chn. setting doesn't denote MIDI channel, but the receiving track's *ordinal number*. For example, if you want to control track G1T1, which is playing a synthesizer on MIDI channel 5, you set Chn. to '1' (and not '5') on the sending track's EVENT page. If you're not controlling *track* settings with CCs, but *sequencer* settings (like CC#03 to set the scale), Chn. setting makes no difference.

It is important to note that sending internal CCs over a bus to control another track *doesn't require any setup in the receiving track*. All the settings are done on the sending track's EVENT page. (Note, however, that if you're trying to control, say, the LFO settings of the receiving track with CC sent from another track, naturally the LFO effect on the receiving track has to be enabled.)

The full list of MBSEQv4 CC implementation is available in Appendix 4.

6.2. Force To Scale

By default the sequencer is playing on a 12-notes-per-octave chromatic scale. If you want that all the notes in a track are in a certain key and mode, you can force them to a chosen scale. This is useful e.g. in combination with randomly generated notes (see section 6.3.), which would be all over the place without Force To Scale. Force To Scale has relevant settings on two pages: FX (MENU + FX) and Mode (MENU + MODE).

```
Root      Selected Scale
Keyb      3:Natural Minor
```

Each individual track has the option of being Forced To Scale. The setting for this is on each track's MODE page. Force to Scale can be either 'off' (default) or 'on'.

There is a Force To Scale related setting also on the Jam page's Misc. menu, which takes the scale setting from the FX Scale page. On the Misc. page, FTS (force to scale) can be turned 'on' and 'off' *for the forwarded notes*, not for the notes that are playing on the track. In other words, if you are not familiar with the piano keyboard, or just have a tendency to fat-finger the wrong notes, FTS is your friend. If the track is forced to scale (on the MODE page), it doesn't affect the forwarded notes that are played live on a MIDI controller, and likewise, the FTS setting (on the Misc. page) doesn't affect the notes on the track.

The scale that each track can individually be forced to is set on the FX page (MENU + FX GPB10 for 'Scale'). There, GPK4-8 can be used to choose one of the 166 predefined scales.

The Root setting sets the root note of the scale. The Root setting is a note (C-B), and the right LCD will display the allowed notes, in the chosen scale. If you set the root to 'C' and 'Selected Scale' to '0:Major', the track that is forced to scale will play only the notes C D E F G A H (the C major scale). If you change 'C' to 'D', the played notes are always and exclusively D E F# G A B C# (the D major scale). "Played notes" means that if the track has any other notes than the allowed ones in it, the unallowed notes will not be left unplayed, but instead they will be forced to the nearest allowed note.

If a track is Forced To Scale, the EDIT page displays the notes that the track is *actually* going to play, the unallowed ones having been forced into the allowed ones; the "real" notes recorded on the track will nevertheless be visible in the right LCD (top row) for the current cursor position, and they will reappear on the track when the Force To Scale setting for the track is switched 'off'.

If Root is set to 'Keyb', the root note is controlled by the keyboard. The note is taken from the same source as the Transpose note of a track, which means the keyboard intended to control the root note has to be sending on a T&A bus (see section 4.1.1.). In this case the right LCD is empty.

6.3. Random generator

Random generator allows you to randomise the data of parameter or trigger layers (and for drum tracks, drum instrument layers). The randomiser menu is found in the main menu, with UTILITY + GPB7 (Rand), or with EDIT + GP13-14.

```
Trk.      Random Generator      Scr1 LayA LayB LayC LayD LayE LayF LayG
G1T1  Generate      Clr. Util Undo <>  64  --  --  All  --  --  --
```

On the randomiser page you can use GPK9 to scroll through the available layers in the active track. LayA, LayB etc. denote parameter layers, and TrgA, TrgB etc. denote trigger layers. If the active track is a Drum type track, drum instrument names are shown instead.

Because the layers are called just LayA, TrgB etc., you have to remember yourself which functions you have assigned to each layer. If you have more than four parameter layers available (depends on track initialisation), you can check the layer assignments quickly by pressing parameter layer selection button C. Likewise, trigger layer assignments can be checked by pressing trigger layer selection button C.

Parameter layers are randomised by setting the intensity of the randomisation. Randomisation starts from parameter value 64, and the randomisation setting allows you to determine how much the random values will deviate from 64. For example, if you enter an intensity value of 5, the randomised value will be 64 +/- 5, in other words, a randomly picked value between 59 and 69. A value of "-" will mean the randomiser will not change the values in that parameter layer.

For trigger layers, the randomiser value denotes the likelihood of the trigger getting turned 'on'; the higher the number, the more likely it is that the trigger in each step will be 'on'. For example, if you choose TrgA (Gate by default) for randomisation, a value of 1 will result in only a few steps having their gates turned 'on', while a value of 14 will result in almost all steps having their gates switched 'on'. By selecting 'All' you can have the randomisation occur for all steps. A value of "-" means randomiser will not change the values in that trigger layer.

Randomising drum instrument layers works the same way as randomising trigger layers.

You can randomise any number of a track's parameter and trigger layers simultaneously by assigning values to all the layers you want to randomise. When you have selected the ones you want to randomise, press GP2-3 to effect the randomisation. If you are unhappy with the result, you can undo it with GPB8 ('Undo'). GPB7 ('Util') takes you back to the UTILITY page, and GPB6 ('Clr.') will clear the active track (which can be undone as well with 'Undo').

Note, Velocity and CC parameter layers, and Gate, Accent and Roll trigger layers are obvious targets for randomisation, but in principle randomiser will work with any type of layer that's available.

The Force To Scale option on the MODE page is particularly useful for randomised note layers. For details on Force To Scale, see section 6.2.

6.4. Euclidean rhythm generator

The Euclidean rhythm generator (ERG) allows you to create rhythms very easily, and change them afterwards with normal track editing. Changing the settings on the ERG page changes the contents of the track immediately, so be careful so as not to lose anything you want to keep.

The ERG works best for Drum type tracks, but in principle it can be used for Note type tracks as well. It can be found in the main menu, or with EDIT + GPB13-14 or in the main menu.

6.4.1. Euclidean rhythm generator for Drum type tracks

On the ERG page, track length can be changed within the maximum length (this is the same setting as on the LENGTH page, and the value will be copied between pages). On the right LCD, there's another length setting, which sets the length of the *loop* (GPK9).

Trk.	TrkLength	Drum	Note	VelN	VelA	RndA	Len	Pulses	Offs.	
G3T2	64/128	CH	F#1	100	127	50%	20	12	0	*.***.**.***.**.*.*.*.

Along with the loop length setting, there's Pulses, which will place the set number of pulses (or gates) over the length of the loop (repeating the pattern over the whole track). For example, if the loop length is 16 steps and the number of pulses is 4, a pulse will be placed each four steps. In principle, any number of pulses will be divided over the given loop length, though in practice a large number of pulses will quickly become impossible to place, if the loop is very short.

Normally each series of pulses starts in the first step of the track, but this can be changed with Offset (GPK11). Offset setting simply inserts that many empty steps in the beginning of the track before the first pulse.

If the loop is shorter than the set track length, the loop will be written onto the track as many times the track length allows. For example, if track length is 16 steps and loop length 13 steps, the loop's 13 steps fit once into the 16 steps of the track; then 3 more steps from the beginning of the loop still, but then the track length runs out. The resulting pattern of 16 steps will be written on the track *over its whole length*, not just the set length. Thus, a track of 16/64 will be written four times with the same 13+3 pattern.

If the loop is longer than the set track length, only what fits into the track length will get repeated. For example if track length is 16 steps and loop length is 20 steps, only the first 16 steps of the loop will be repeated. If the track is 16/64, this truncated 16-step pattern will be written on the track four times.

Offhand it might not make sense to use loops longer than the set track length. However, because the pulses are divided as evenly as possible over the loop length, whether it's longer or shorter than the set track length, you can effect rhythm patterns with loops longer than the track that are not possible is the loop is shorter than, or equally long as, the track.

Note that when you change Len, Pulses or Offset settings, the ERG will immediately write the loop repeatedly *over the whole track*, not just over the set length of it, overwriting anything that was there previously.

On the left LCD, you can change the drum instrument layer to be edited by ERG with GPK4. Also the note that the instrument layer is playing can be changed. With GPK6-7 you can change the Normal (VelN) and Accent (VelA) velocities. (The mentioned settings are the same as on the EVENT page, and the values will be copied between pages.) The velocity values for each pulse can be randomised with GPK8. Turning GPK8 will simultaneously set the likelihood of a pulse getting an accent, as well as effect the randomisation.

6.4.2. Euclidean rhythm generator for Note type tracks

It is possible to use the ERG with a Note type track as well. However, even with the Note type tracks, the ERG is still essentially a rhythm creating aid. The ERG will leave the Note layer values untouched, but will switch the gates 'on' and 'off' based on the loop length, pulse and offset settings you make. For track length, normal/accent velocity settings and their randomisation (VelN, VelA and RndA), loop length, pulses and offset settings, see section 6.4.1. for the details.

```
Trk. TrkLength ParA Val. VelN VelA RndA Len Pulses Offs.  *.*..*..*..*..*..*..*
G1T1 64/128 Note Orig 100 127 50% 16 6 0
```

The main difference to Drum type tracks is that you can change the Note type track's parameter layer values. The exception is that the the first parameter layer contents cannot be edited (the entry says 'Orig'), whether it is a note layer or something else. Also it is important to note that changing the content of a parameter layer on the ERG page *affects all the pulsed steps*. Thus, changing the velocity value will change the velocity values of all those steps which are "pulsed", i.e. where the ERG has set the gate 'on'.

One useful way to use the ERG with Note type tracks is creating a rhythmic pattern on the ERG, then leaving the page and changing the notes to something more tonal than what the ERG is capable of.

6.5. Mixer maps

The mixer maps on the MIXER page (MENU + MIXER) allow you to send Program Change and Control Change messages to your MIDI equipment. Each session has a maximum of 127 mixer maps, which

can be named and customised, and each mixer map has 12 pages, one page for each kind of setting. The pages can be changed with the datawheel, or the up and down buttons on the frontpanel.

```
Mixer Map # 1 Page [ 4 ] Volume IIC1 Chn#12
127 127 127 127 127 127 127 127 127 127 127 127 127 127 127 127
```

Each mixer map page has 16 different slots for customised commands that can be sent simultaneously. The first two pages of a mixer map define, first, the *output port* on which the message for each of the 16 slots is sent, and second, the *MIDI channel* on which the message for each slot is sent. The default value for Port is 'Def.', i.e. the setting is taken from the MIDI Router page (see section 2.1.2. or Appendix 3). The default MIDI channel is '# 1' for the first slot, '# 2' for the second, and so on.

The Port and MIDI channel are the foundational settings for each mixer map slot, without which the messages won't be sent to the right place; they don't send any command by themselves, they just set the conduit for the commands from the other pages. For example, if you've set track G1T1 to play a synthesizer connected to OUTPUT1 on MIDI channel 5 (settings made on the track's EVENT page), you should set one of the slots on the mixer map page to that port and that MIDI channel to send a message from the mixer map to that synthesizer. While you're on the MIXER page, the port and channel for the slot in the current cursor position will always be visible in the upper right corner of the right LCD.

Once Port and MIDI channel are in order, the actual messages that you can send are:

- Page 3: Program Change
- Page 4: Volume
- Page 5: Panorama ("Pan")
- Page 6: Reverb
- Page 7: Chorus
- Page 8: Modulation wheel
- Page 9: Freely assignable CC (CC1)
- Page 10: Freely assignable CC (CC2)
- Page 11: Freely assignable CC (CC3)
- Page 12: Freely assignable CC (CC4)

The freely assignable CCs for pages 9-12 are the standard MIDI CCs.

While on the MIXER place, pressing & holding SELECT brings up a utility menu. GPB2 and GPB4 ('Copy', 'Clr') copy and clear the current mixer map, and GPB3 ('Paste') pastes a previously copied mixer map into the current one. GPB7 saves the current mixer map, and and GPB6 allows you to load a previously saved map. GPK1 switches between the 127 possible mixer maps in the session. Switching away from the current map will erase any unsaved changes. GPB16 allows you to name the current mixer map.

```
Map# Mixer Utility Functions CC Assignments LiveSend Edit
127 Copy Paste Clr Load Save Dump CC1 CC2 CC3 CC4 on Name
```

There are four ways to send mixer map commands to their destinations.

The easiest way is to press a GP button under an entry. Pressing the GP button will simply send once the values or commands in the whole "stack" of slots (i.e. commands from page 3, page 4 etc.). The second option is available in the utility menu: 'Dump' (GPB8) will send all the commands in the 16 slots of all 10 command pages to the ports and MIDI channels set for each "stack" of slots. The third

option can be enabled in the mixer utility menu (press & hold SELECT): LiveSend can be set 'on' or 'off'. If LiveSend is 'on', the values in the slots of all pages in the current mixer map will be active all the time, and all changes will be updated immediately. For example, mixer page 4 (Volume) could be used as a centralised volume control for all your MIDI equipment.

The fourth way to send mixer map values is on the SONG page, as a song position action ('Mixer Map #').

Appendix 1. Customising some button functions

Function buttons F1-F4

In the root of the SD card there is a file named MBSEQ_HW.V4. This is the hardware setup file. Most of the settings there don't need changing, and are anyway beyond the scope of this guide. However, on the Wilba frontpanel there are four buttons labelled F1, F2, F3 and F4, which can be customised relatively easily (and are meant to be so). The default functions for the buttons are:

- F1: Quick access to the Track Selection page
- F2: Quick on/off toggle of live forward mode (Fwd)
- F3: Quick on/off toggle of recording (Rec)
- F4: Save the complete session

In the HW setup file they appear like this:

```
# F1 is located at SR M3 Pin 3
# F2 is located at SR M2 Pin 2
# F3 is located at SR M2 Pin 3
# F4 is located at SR M1 Pin 2

#           SR Pin  <-- this line begins with a #, so it's
"commented out" (not part of the code)
BUTTON_TRACK_SEL      M3  3  <-- this line defines button F1 as the Track
Selection button
BUTTON_LIVE           M2  2  <-- this line defines button F2 as the Fwd
toggle button
BUTTON_REC            M2  3  <-- etc.
BUTTON_SAVE_ALL       M1  2
```

If you want to change the default functions, all you need to do is keep the "BUTTON_" in the start of the line, add your preferred function after it, and leave the SR and Pin columns unchanged. The possible button functions are listed in HW setup file, and are of the form:

```
#           SR Pin
BUTTON_STOP           M3  5
BUTTON_PAUSE          M2  4
BUTTON_PLAY           M2  5
BUTTON_MUTE_ALL_TRACKS      0  0
```

```
BUTTON_MUTE_TRACK_LAYERS      0  0
BUTTON_MUTE_ALL_TRACKS_AND_LAYERS 0  0
BUTTON_UNMUTE_ALL_TRACKS      0  0
BUTTON_UNMUTE_TRACK_LAYERS    0  0
BUTTON_UNMUTE_ALL_TRACKS_AND_LAYERS 0  0
```

Lines that have a non-zero entry for the SR and Pin columns are already assigned somewhere (like stop, pause and play above), so there is no need to assign them to another button. However, entries with zeros in the SR and Pin columns (like “mute all tracks” and “unmute all tracks” above) are potential candidates for F1-F4 button functions. For example, if you want to have a dedicated button for “mute all tracks”, you should change one of the F1-F4 button entries to contain “BUTTON_MUTE_ALL_TRACKS”. You could replace “BUTTON_BOOKMARK”, for example, as bookmarks are easily available with MENU + SELECT as well.

It is important to note that if you enable e.g. “mute all tracks” for one of the F1-F4 buttons, *you must “comment out”* the line where “mute all tracks” is set to SR 0 Pin 0. If the “zero address” setting is not “commented out” in the file, it will have the effect of disabling the setting. “Commenting out” is done by placing a # in front of the line, so that

```
BUTTON_MUTE_ALL_TRACKS      0  0
```

becomes

```
#BUTTON_MUTE_ALL_TRACKS    0  0
```

Button behaviour (momentary/toggle)

In the HW setup file it is possible to change the behaviour of a number of buttons, so that they do their function while the button is pressed & held, or the button function is toggled 'on' and 'off' with a single press. For example, momentary pressing & holding the MENU button shows the MENU page only as long as the button is pressed & held, and you have to press another button while pressing & holding the MENU button in order to choose a menu page. If you've set the MENU button to toggle, you can just press MENU once and then press another button to choose a menu (or press MENU again to return to the current page). This allows you to make menu page selections with one hand.

This is the relevant section of the HW setup file for configuring button behaviour:

```
#####
# Button behaviour
# 0: active mode as long as button pressed
# 1: pressing button toggles the mode
#####

BUTTON_BEH_FAST      1
BUTTON_BEH_FAST2     0
BUTTON_BEH_ALL       1
BUTTON_BEH_SOLO      1
```

BUTTON_BEH_METRONOME	1
BUTTON_BEH_LOOP	1
BUTTON_BEH_FOLLOW	1
BUTTON_BEH_SCRUB	0
BUTTON_BEH_MENU	1
BUTTON_BEH_BOOKMARK	1
BUTTON_BEH_STEP_VIEW	0
BUTTON_BEH_TRG_LAYER	1
BUTTON_BEH_PAR_LAYER	1
BUTTON_BEH_TRACK_SEL	0
BUTTON_BEH_TEMPO_PRESET	0

Appendix 2. Bookmarks

The Bookmarks menu is available in the main menu (press EXIT once or a few times, depending on where you are), or by pressing MENU + SELECT.

Bookmarks allow you to store frequently used pages and settings to be recalled at the push of a button. There are two kinds of bookmarks: global and local (session dependent) bookmarks, eight each. In the Bookmarks menu the global bookmarks are available in the left LCD, and the local ones in the right LCD. Global bookmarks are available in all sessions, while local bookmarks are particular to each session.

However, it is possible to copy local bookmarks across sessions in the Sessions Import/Export menu (UTILITY → Disk → Sessions Import). Choose the source session in the right LCD and turn GPK9 to select 'Bookmarks' as the imported type. Pressing 'IMPORT' will replace the current session's local bookmarks with the imported ones.

A bookmark can be recalled by going to the Bookmark page and pressing a button to select the bookmark you want.

A bookmark can be stored by going to the Bookmarks page and pressing & holding a GP button for 3 seconds. The page that was selected before entering the Bookmarks page is stored, along with a number of settings. (See the example below.)

Bookmark names can be changed only by editing the global or local bookmark files, both called MBSEQ_BM.V4. The maximum length for a name is five characters. If you absolutely must have more than five characters for the name, you could save the same bookmark on two adjacent slots and edit their names in the bookmark file so that the one on the left in the pair has five characters and the one on the right has up to four characters.

The global bookmarks file is at the root of the SD card, and the local ones are in the same folder as the session which the bookmarks belong to.

Besides the bookmark name, it is possible to edit also the other bookmark parameters by hand in the bookmark files. The example below also lists the settings which are stored in a bookmark.

```
#####
```

```
Slot 1          <- slot name, do not edit! Slots 1-8 = global bookmarks,
9-16 local bookmarks
Name Def.       <- replace "Def." for custom bookmark name (max. five
characters)
#####
+Page EDIT      <- name of selected page
+Group 1        <- selected group number, 1-4
+Tracks 1000000000000000    <- selected tracks, 1 = track selected, 0 =
track not selected
+Mutes 0000000000000000    <- selected mutes, 1 = track muted, 0 = track
not muted
+ParLayer A     <- selected parameter layer, A-P
+TrgLayer A     <- selected trigger layer, A-G
+Instrument 1   <- selected instrument (useful only for drum tracks)
+StepView 1    <- Step View mode on or off
+Step 1        <- selected step (cursor position)
+EditView 0    <- Edit view mode, 0 = step view, 1 = layer view, 2 =
trigger view, 3 = 303 view
+Solo 0        <- solo button mode on or off
+All 0         <- ALL button mode on or off
+Fast 0        <- FAST button mode on or off
+Metronome 0   <- metronome on or off
+LoopMode 0    <- loop mode on of off
+FollowMode 0  <- follow mode on or off
```

The plus or minus sign in the beginning of each line can be used to prevent the setting from being overwritten by a bookmark, when you store it on the bookmark page. Plus allows overwriting, minus prevents it. For example, the line

The list of available Pages are is found in [seq_ui_pages.h](#)

```
-Tracks 1111000000000000
```

would mean that if you save a bookmark in the same location, the track selection won't be stored, but it will always be what's written in the bookmark file - in this case, this bookmark will always select tracks 1-4, no matter what the track selection status happens to be at the moment you save the bookmark in this slot.

Appendix 3. The MIDI Router

You can access the MIDI Router page from the main menu, or with MENU + MIDI MIDI Router (GPB5-6). The MIDI Router allows you to route incoming MIDI messages from any of the input ports to any of the output ports. *It is independent from the other MIDI settings of the sequencer*, and in some instances you have to pay attention so as not to have parallel in/out settings - this can lead to e.g. notes getting forwarded twice.

Transposer and Arr.	Section	MIDI	Ext.	Node	IN P/Chn	OUT P/Chn	DefaultPort
	Control	Router	Ctrl Misc.	#1	Def. All	Def. # 1	USB1

The router has a maximum 16 nodes, each of which governs the routing from *one input port to one output port*, with further optional channel limitations. All the nodes are in effect simultaneously. On the input side, GPK9 selects the node to be edited, GPK10 selects the physical input port on which the messages are coming in, and GPK11 selects the MIDI channel that is allowed through. The channel setting (GPK11) can be:

- a) 1 to 16, for allowing messages on single MIDI channel;
- b) 'All' for allowing messages on all channels; or
- c) '—', which effectively disables the node, as no MIDI channel is allowed through.

On the output side, GPK12 selects the output port where the node's input port's MIDI messages are routed to. GPK13 selects the MIDI channel which the outgoing message is sent on. The outgoing channel doesn't have to be the same as the original incoming channel, so you can e.g. transform incoming channel 1 to outgoing channel 13. Channel options are:

- a) 1 to 16 for a single MIDI channel. All incoming MIDI messages, regardless of their original channel, are sent out on this channel;
- b) 'All' for sending the message on its original channel; or
- c) two special options: Track and Selected Track (Sel.Trk).

If the output port/channel option is 'Track', the router will direct the incoming messages to the track whose *ordinal number* matches the incoming MIDI channel (provided that the input port/channel options allow the message through). For example, if you have a MIDI controller that's sending MIDI data on channel 7, 'Track' option will send the message out on the port and MIDI channel set on track 7's (G2T3) EVENT page. MIDI channel 10 will get sent out on track 10 (G3T2), etc.

If the output channel option is 'Sel.Trk' (Selected Track), the router will direct the incoming messages to the sequencer track that is *currently active* (provided that the input port/channel options allow the message through). If you have several tracks selected, the MIDI message will go out on the channel with the lowest ordinal number (track 1 before track 2, track 5 before track 6 etc.)

The final option on the MIDI Router page is DefaultPort. The tracks' EVENT page and a few other pages allow you to select 'Def.' as one of the Port options. If you select 'Def.' as the Port, it will refer to the Default Port setting on the MIDI Router page.

Note that the router settings might overlap with the Jam page note live forwarding option ('Fwd'). If you have Fwd 'on', it will forward incoming MIDI messages on the 'Jam' bus (see section 4.1.1.) to the active track's output port, set on the track's EVENT page. This is done regardless of any MIDI Router settings. However, if Fwd is 'on', and at the same time you have a MIDI Router node routing MIDI messages to the same port and channel as Fwd is forwarding them, MIDI messages like notes will get triggered twice, almost simultaneously. This most likely alters how the note will sound, and perhaps causes hanging notes. If you are using the MIDI Router to forward MIDI messages from one or several MIDI controllers to output ports, you might want to make sure that Fwd on the Jam page is 'off'. On the other hand, note that the Live Patterns function depends on Fwd being on. (See section 4.1.5.)

If you have two MIDI keyboards, one in IN1 (a plain MIDI controller) and the other in IN2 (a keyboard synthesizer that's sending on, and listening to, channel 1), you could set them up so that one of them always plays the channel it is set to send on, and the other always plays the currently selected (active) sequencer track. Let's say you want to set your keyboard synth to

play the active track (selectable on the group and track selection buttons on the sequencer), and the plain MIDI controller to play the channel you've selected on the controller. For this to work optimally, you need to turn the Jam page Fwd option 'off' to avoid forwarding messages twice. Also, you want to set your keyboard synthesizer's 'local' function off, so that the synth is triggered only via MIDI.

On the MIDI Router page, set Node 1 like this for the plain MIDI controller:

	IN Chn./P	OUT Chn./P
Node 1	IN1 All	OUT1 All

This lets through all messages coming in at IN1 on all channels, and directs them to OUT1 on the same channel it came in on. In other words, if the incoming message at IN1 is on channel 11, it is forwarded to OUT1 on channel 11. This setup is very useful if you have a multitimbral synthesizer that can be played on several MIDI channels, or you have several synths connected to OUT1, either with MIDI Thru boxes or by daisy-chaining equipment with their MIDI Thru (soft or hard) ports. However, if you're using only one synth in each output port, you can make a dedicated node for each output port:

	IN Chn./P	OUT Chn./P
Node 2	IN1 All	OUT1 All
Node 3	IN1 All	OUT2 All
Node 4	IN1 All	OUT3 All
Node 5	IN1 All	OUT4 All

With these settings, everything coming in on IN1 will be routed simultaneously to output ports OUT1-4. This way you can control the synths at each output port with a single MIDI controller at IN1, just by changing the sending channel on the MIDI controller.

Node 2, for the keyboard synthesizer, is set up like this:

	IN Chn./P	OUT Chn./P
Node 2	IN2 #1	Sel.Trk

Node 2 contains the settings for the keyboard synthesizer, which is connected to IN1, and set to send on, and listen to, exclusively channel 1. This way you can use the keyboard synth to play itself via the sequencer (remember to turn the synth's 'local' setting 'off'), but also any other synth that you have connected to the sequencer, just by using the group and track selection buttons to select the right track on the sequencer.

Appendix 4. MBSEQv4 CC implementation

The following is a simplified list of what a track's configuration consists of. The full information can be

found below.

- FX settings - Pattern Bank change commands - Track MODE settings - Track TRANSPOSE settings - Track DIRECTION settings - Track DIVIDER settings - Loop points - Track LENGTH - GROOVE styles - MORPH settings

If you want to use a track to send internal CCs over a bus to change the sequencer's settings, set the sending track's Port to 'Bus1', Chn. to the receiving track's *ordinal number* (and *not* midi channel!), select a CC parameter layer and then select one of the available CC options with GPK11-13. The options are listed on the display in an abbreviated form, but in the table below they are written out in full. Also the possible values for each CC are detailed in the table below; the "NPRN LSB" column's rightmost number matches the CC number on the sequencer. For example, if you want to control another track's LFO waveform (in the track's FX menu), you select CC#16 and set the value to somewhere between 0 and 22.

- o CC#1 (0x01 - Modulation Wheel)
Controls the Morphing Function
- o CC#3 (0x03 - Scale)
Controls the Global Scale
- o CC#112-CC#115 (0x70-0x73)
Change Pattern of Group #1/2/3/4
- o CC#116-CC#119 (0x74-0x77)
Bank Pattern of Group #1/2/3/4
- o CC#98 (0x62 - NRPN LSB)
Selects the Sequencer Parameter which should be modified via NRPN
See list below
- o CC#99 (0x63 - NRPN MSB)
Selects the Track which should be modified via NRPN
Allowed values: 0..15 for Track 1-16, 127 to modify the current selected track
All others reserved for future enhancements
- o CC#6 (0x06 - NRPN Value, LSB)
Sets a Sequencer Parameter depending on the preselected track and parameter number
- o CC#123 (0x7b - All Notes Off)
if 0 is received, all transposer/arpeggiator/patch changer notes will be reset, and notestacks will be emptied
Values > 0 will be ignored

NRPN LSB	Range	Default	Description
=====+	=====+	=====+	=====

====				
0x00/ 0	-		-	reserved
...				
0x0f/ 15				
-----+-----+-----+-----+-----				

0x10/ 16	0 - 22		0	LFO Waveform
				0: off
				1: Sine
				2: Triangle
				3: Sawtooth
				4: Rectangle 05
				5: Rectangle 10
				...
				22: Rectangle 95
-----+-----+-----+-----+-----				

0x11/ 17	0 - 127		64	LFO Amplitude
				0x00..0x3f: negative range
				0x40: no amplitude
				0x41..0x7f: positive range
				Note: range is 0x00..0xff if edited from CS
-----+-----+-----+-----+-----				

0x12/ 18	0 - 99		0	LFO Phase:
				0: 0%
				1: 1%
				2: 2%
				...
				99: 99%
-----+-----+-----+-----+-----				

0x13/ 19	0 - 127		15	LFO Interval in Steps:
				0: 1 Step
				1: 2 Steps
				2: 3 Steps
				...
				127: 128 Steps
				Note: range is 1..256 steps if edited from CS
-----+-----+-----+-----+-----				

0x14/ 20	0 - 127		15	LFO Interval Reset:
				0: after 1 Step
				1: after 2 Steps
				2: after 3 Steps
				...
				127: after 128 Steps
				Note: range is 1..256 steps if edited from CS

```

-----+-----+-----+-----
---
0x15/ 21|  0 - 31 |      0 | LFO Flags:
      |      |      |   bit 0: Oneshot Mode on/off
      |      |      |   bit 1: Note Assignment on/off
      |      |      |   bit 2: Velocity Assignment on/off
      |      |      |   bit 3: Length Assignment on/off
      |      |      |   bit 4: CC Assignment on/off
      |      |      |   bit 5: Extra CC Assignment off/on
(inverted!)
-----+-----+-----+-----
---
0x16/ 22|  0 - 127 |      0 | LFO Extra CC Number
-----+-----+-----+-----
---
0x17/ 23|  0 - 127 |     64 | LFO Extra CC Offset (0..127)
-----+-----+-----+-----
---
0x18/ 24|  0 -  8  |      6 | LFO Extra CC PPQN
      |      |      |   0: 1 PPQN
      |      |      |   1: 3 PPQN
      |      |      |   2: 6 PPQN
      |      |      |   3: 12 PPQN
      |      |      |   4: 24 PPQN
      |      |      |   5: 48 PPQN
      |      |      |   6: 96 PPQN
      |      |      |   7: 192 PPQN
      |      |      |   8: 384 PPQN
-----+-----+-----+-----
---
0x19/ 25|  -      |      - | reserved
...
0x1c/ 28|      |      |
-----+-----+-----+-----
---
0x1d/ 29|  0 -128 |      0 | Pattern Bank Change (Low-Byte)
      |      |      |   0: off
      |      |      |  1-128: Bank Selection (Low-Byte)
-----+-----+-----+-----
---
0x1e/ 30|  0 -128 |      0 | Pattern Bank Change (High-Byte)
      |      |      |   0: off
      |      |      |  1-128: Bank Selection (High-Byte)
-----+-----+-----+-----
---
0x1f/ 31|  0 -128 |      0 | Pattern Program Change
      |      |      |   0: off
      |      |      |  1-128: Program Change Selection
-----+-----+-----+-----
---
0x20/ 32|  0 -  3  |      1 | Track Mode

```

			0: off 1: Normal 2: Transpose 3: Arpeggiator
-----+-----+-----+-----			
0x21/ 33	0 - 15	2	Track Mode Flags bit 0: Unsorted Arp Stack on/off bit 1: Hold on/off bit 2: Restart on/off bit 3: Force Scale on/off bit 4: Sustain on/off
-----+-----+-----+-----			
0x22/ 34	0 - 3	0	Track Event Mode 0: Note 1: Chord 2: CC 3: Drum
-----+-----+-----+-----			
0x23/ 35	0 - 127	0	Limit Fx: Lower Note Number (0=off)
0x24/ 36	0 - 127	0	Limit Fx: Upper Note Number (0=off)
-----+-----+-----+-----			
0x25/ 37	0 - 3	0	Transposer/Arpeggiator Bus assignment (Bus1..Bus4)
-----+-----+-----+-----			
0x26/ 38	0 - 15	0	MIDI Channel of Track
-----+-----+-----+-----			
0x27/ 39	0 - 127	0	MIDI Port of Track 0x00: Default 0x10: USB1 0x11: USB2 0x12: USB3 0x13: USB4 0x20: OUT1 (MIDI Out Port #1) 0x21: OUT2 (MIDI Out Port #2) 0x22: OUT3 (MIDI Out Port #3) 0x23: OUT4 (MIDI Out Port #4) 0x30: IIC1 0x31: IIC2 0x32: IIC3 0x33: IIC4 0x60: CV1 0x61: CV2 0x70: Bus1 (Loopback) 0x71: Bus2

			0x72: Bus3
			0x73: Bus4
-----+-----+-----+-----			

0x28/ 40	0 - 6	0	Track Direction
			0: Forward
			1: Backward
			2: Ping Pong
			3: Pendulum
			4: Random Direction
			5: Random Step
			6: Random Direction and Step
-----+-----+-----+-----			

0x29/ 41	0 - 15	0	Steps Replay: (0..15 = x1..x16)
0x2a/ 42	0 - 15	0	Steps Forward (0..15 = 1..16 steps)
0x2b/ 43	0 - 15	0	Steps Jump Back (0..15 = 1..16 steps)
-----+-----+-----+-----			

0x2c/ 44	0 - 127	15	Clock Divider (in 384ppqn steps)
-----+-----+-----+-----			

0x2d/ 45	0 - 127	15	Track Length (0..127 = 1..127 steps)
			Range is 0x00..0xff = 1..256 steps if edited from CS
-----+-----+-----+-----			

0x2e/ 46	0 - 31	0	Loop Point (0..127 = step 1..128)
			Range is 0x00..0xff = 1..256 steps if edited from CS
-----+-----+-----+-----			

0x2f/ 47	0 - 3	0	Clock Divider Flags:
			Bit 0: Synch to Measure
			Bit 1: Triplets
			Bit 2: Manual (Clock the next step only on manual requests (or via Step CC))
-----+-----+-----+-----			

0x30/ 48	0 - 15	0	Transpose Semitones
			8: -8 semitones
			9: -7 semitones
			10: -6 semitones
			11: -5 semitones
			12: -4 semitones
			13: -3 semitones
			14: -2 semitones
			15: -1 semitones
			0: no transpose
			1: +1 semitones
			2: +2 semitones

			3: +3 semitones
			4: +4 semitones
			5: +5 semitones
			6: +6 semitones
			7: +7 semitones

0x31/ 49	0 - 15	0	Octave Transpose
			8: no transpose, full range pot control
			9: -7 Octaves
			10: -6 Octaves
			11: -5 Octaves
			12: -4 Octaves
			13: -3 Octaves
			14: -2 Octaves
			15: -1 Octave
			0: +0 Octaves
			1: +1 Octave
			2: +2 Octaves
			3: +3 Octaves
			4: +4 Octaves
			5: +5 Octaves
			6: +6 Octaves
			7: +7 Octaves

0x32/ 50	0 - 21	0	Groove Style
			0: off
			1: Shuffle
			2: Inv. Shuffle
			3: Shuffle2
			4: Shuffle3
			5: Shuffle4
			6: Shuffle5
			7..21: Custom Grooves 1-16

0x33/ 51	0 - 15	0	Groove Intensity

0x34/ 52	0 - 1	0	Morph Mode
			0: off
			1: on

0x35/ 53	0 - 128	0	Morph Destination Range
			0..127 select offset step 1..128
			Range is 1..256 steps if edited from CS

0x36/ 54	0 - 127	0	Humanize Mode: Random Intensity
-----+-----+-----+-----			

0x37/ 55	0 - 7	0	Humanize Mode: Assignments
			bit 0: Note
			bit 1: Vel./CC Value
			bit 2: Length
-----+-----+-----+-----			

0x38/ 56	0 - 9	0	Assignment for Drum Parameter Layer A
			0: None
			1: Note
			2: Chord
			3: Velocity
			4: Length
			5: CC
			6: PitchBend
			7: Probability
			8: Delay
			9: Roll
0x39/ 57	0 - 9	0	Assignment for Drum Parameter Layer B
-----+-----+-----+-----			

0x3a/ 58	-	-	reserved
0x3b/ 59	-	-	reserved
-----+-----+-----+-----			

0x3c/ 60	0 - 15	0	Steps Repeat (0..16)
0x3d/ 61	0 - 15	0	Steps Skip (0..16)
0x3e/ 62	0 - 63	0	Steps Interval (0..63 = 1..64 steps)
-----+-----+-----+-----			

0x3f/ 64	-	-	reserved
-----+-----+-----+-----			

0x40/ 65	0 - 8	1	Trigger Layer Assignment for Gate
0x41/ 66	0 - 8	2	Trigger Layer Assignment for Skip
0x42/ 67	0 - 8	3	Trigger Layer Assignment for Accent
0x43/ 68	0 - 8	4	Trigger Layer Assignment for Glide
0x44/ 69	0 - 8	5	Trigger Layer Assignment for Roll
0x45/ 70	0 - 8	6	Trigger Layer Assignment for Random Gate
0x46/ 71	0 - 8	7	Trigger Layer Assignment for Random Value
0x47/ 72	0 - 8	8	Trigger Layer Assignment for No Fx
-----+-----+-----+-----			

0x48/ 73	-	-	reserved
...			
0x4f/ 79			
-----+-----+-----+-----			

0x50/ 80	0 - 15	0	Echo Repeats (0..15)

	64		Flag #6 will disable echo (but keep the repeats)

0x51/ 81	0 - 15	0	Echo Delay:
			0: 64T
			1: 64
			2: 32T
			3: 32
			4: 16T
			5: 16
			6: 8T
			7: 8
			8: 4T
			9: 4
			10: 2T
			11: 2
			12: 1T
			13: 1
			14: Rnd1
			15: Rnd2
			16: 64d
			17: 32d
			18: 16d
			19: 8d
			20: 4d
			21: 2d
			22: 0

0x52/ 82	0 - 40	15	Initial Velocity Level:
			0: 0%
			1: 5%
			2: 10%
			...
			20: 100%
			...
			40: 200%

0x53/ 83	0 - 40	15	Feedback Velocity Level:
			0: 0%
			1: 5%
			2: 10%
			...
			20: 100%
			...
			40: 200%

0x54/ 84	0 - 127	64	Feedback Note Value: 0..63: decrements (-64..-1) 64: no increment 65..127: increments (+1..+63)
-----+-----+-----+-----			
0x55/ 85	0 - 40	15	Feedback Gatelength: 0: 0% 1: 5% 2: 10% ... 20: 100% ... 40: 200%
-----+-----+-----+-----			
0x56/ 86	0 - 40	15	Feedback Ticks (Delay): 0: 0% 1: 5% 2: 10% ... 20: 100% ... 40: 200%
-----+-----+-----+-----			
0x57/ 87	-	-	reserved
-----+-----+-----+-----			
0x58/ 88	0 - 40	0	Fx MIDI Mode bit 0..3: Behaviour 0: Forward to all channels 1: Alternate between channels 2: Alternate only on Echo Taps 3: Forward to Random channel 4..7: reserved bit 4: Forward CCs, PitchBender, Channel Pressure, Program Change to all Fx channels
-----+-----+-----+-----			
0x59/ 89	0 - 40	0	Fx MIDI Port 0x00: Same as configured for track 0x10: USB1 0x11: USB2 0x12: USB3 0x13: USB4 0x20: OUT1 (MIDI Out Port #1) 0x21: OUT2 (MIDI Out Port #2) 0x22: OUT3 (MIDI Out Port #3) 0x23: OUT4 (MIDI Out Port #4)

			0x30: IIC1
			0x31: IIC2
			0x32: IIC3
			0x33: IIC4
			0x60: CV1
			0x61: CV2
-----+-----+-----+-----			

0x5a/ 90	0 - 15	0	Fx MIDI Channel
-----+-----+-----+-----			

0x5b/ 91	0 - 15	0	Number of Fx MIDI Channels
-----+-----+-----+-----			

0x5c/ 92	-	-	reserved
...			
0x7f/127			
-----+-----+-----+-----			

From: <https://wiki.midibox.org/> - **MIDIbox**

Permanent link: https://wiki.midibox.org/doku.php?id=mididocs:seq:beginners_guide:start

Last update: **2024/06/27 04:59**

