

# SD Card Module

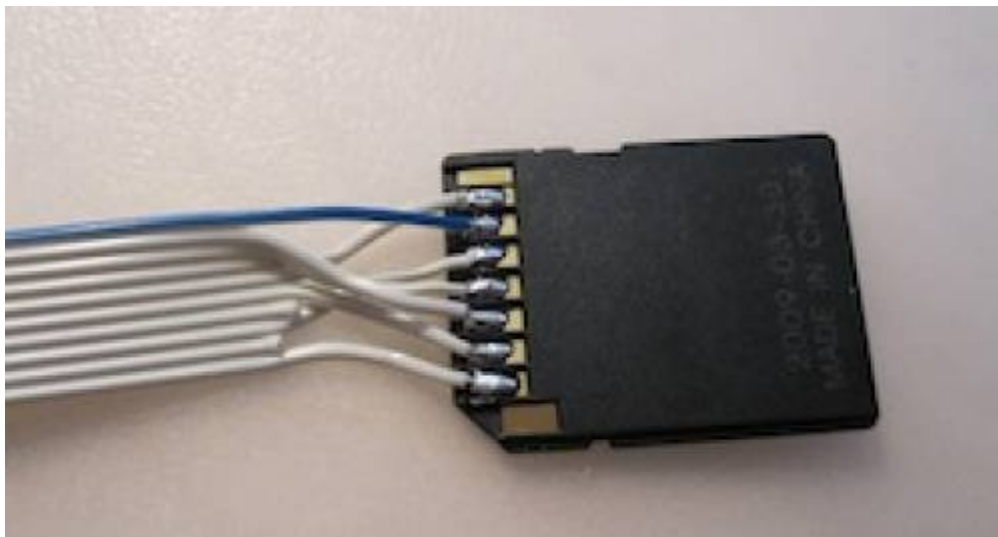

## Interconnection

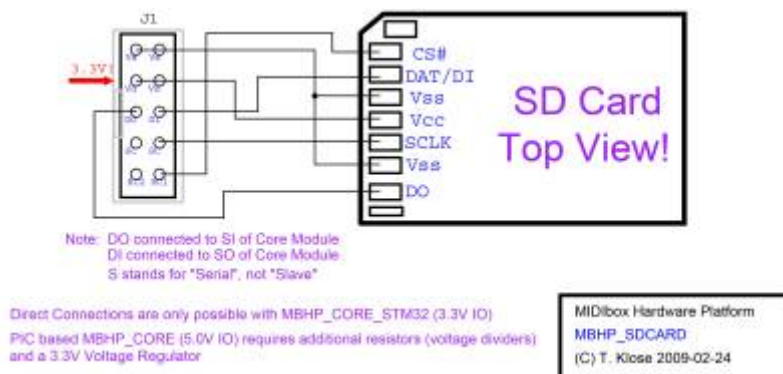

## STM32 Specific

The resistor array R30 of the MBHP\_CORE\_STM32 module shouldn't be connected when a SD Card is used, because pads are configured in Push-Pull mode at 3.3V. SD Card transfers could work unstable with these Pull-Up resistors!

From: <https://wiki.midibox.org/> - **MIDIbox**

Permanent link: [https://wiki.midibox.org/doku.php?id=sd\\_card\\_module&rev=1467025183](https://wiki.midibox.org/doku.php?id=sd_card_module&rev=1467025183)

Last update: **2016/06/27 10:59**

