

Switch

Introduction

A switch is a small lever or button. It's an electrical device having at least **two states**, ON (the closed state) or OFF (the open state).

Ideally, a switch device has zero impedance when closed and infinite impedance when open. The switches on the back of printers and on expansion boards are called DIP switches.

A switch that has just two positions is called a toggle switch. A “click switch” is called SPST switch.

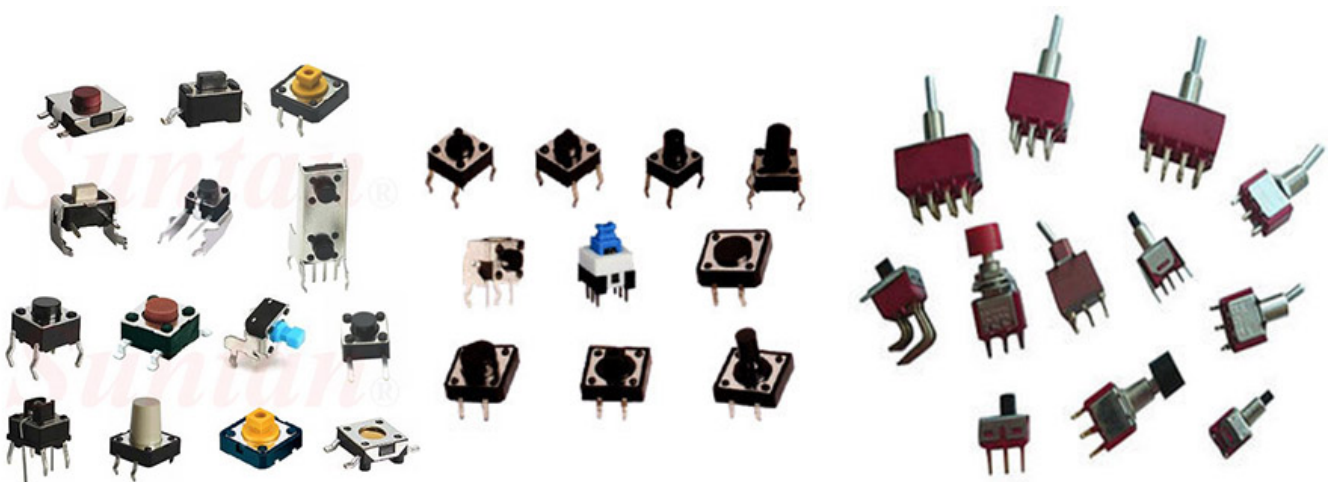

Some Refs?

There is thousands of switches, describing them here would be impossible.

You should have a look to [Switch Choosing Guide](#)

DIN Connection

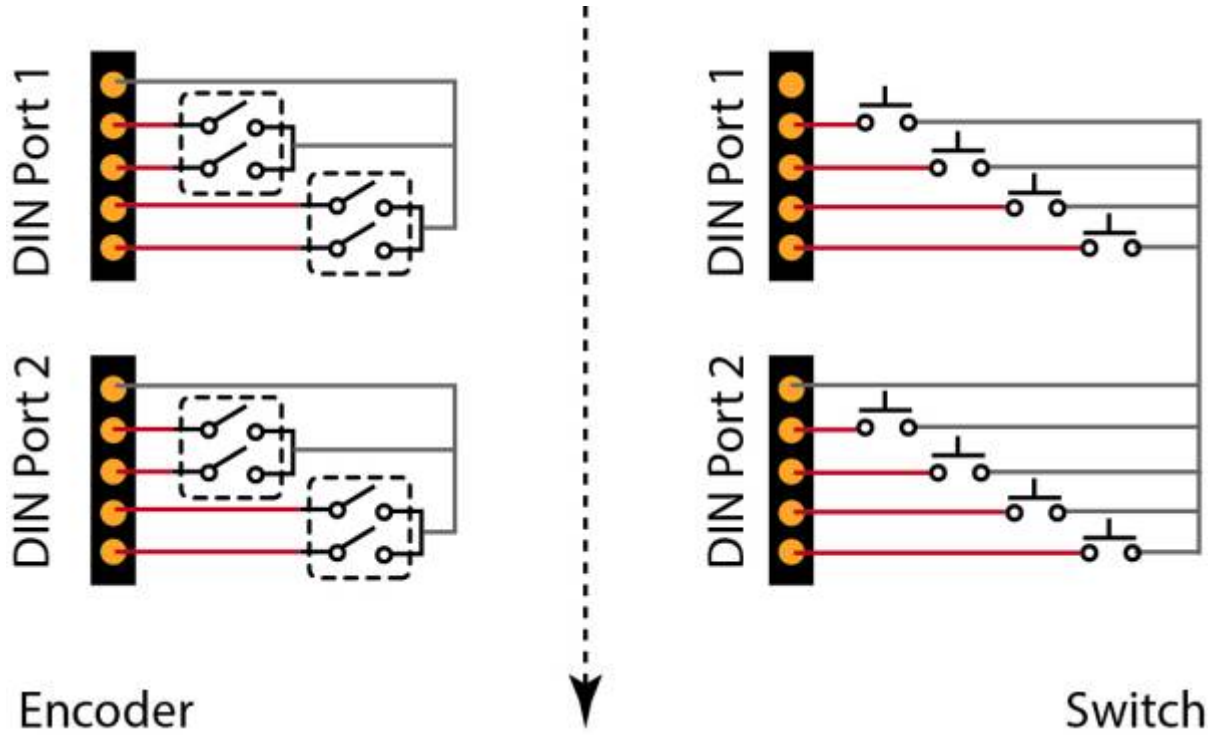

From:

<https://wiki.midibox.org/> - **MIDIbox**

Permanent link:

<https://wiki.midibox.org/doku.php?id=switch&rev=1468151605>

Last update: **2016/07/10 11:53**

