

TM5 Housing

this is the Housing for [Triggermatrix5](#)



Panels



Frontpanel for Milling

if you own a CNC-Machine, you can use this design, otherwise its cheaper if you leave out those 1,5mm depth Display-Planes, because then you can Lasercut! and thats cheaper
[tm5-frontpanel.zip](https://wiki.midibox.org/doku.php?id=tm5-frontpanel.zip)

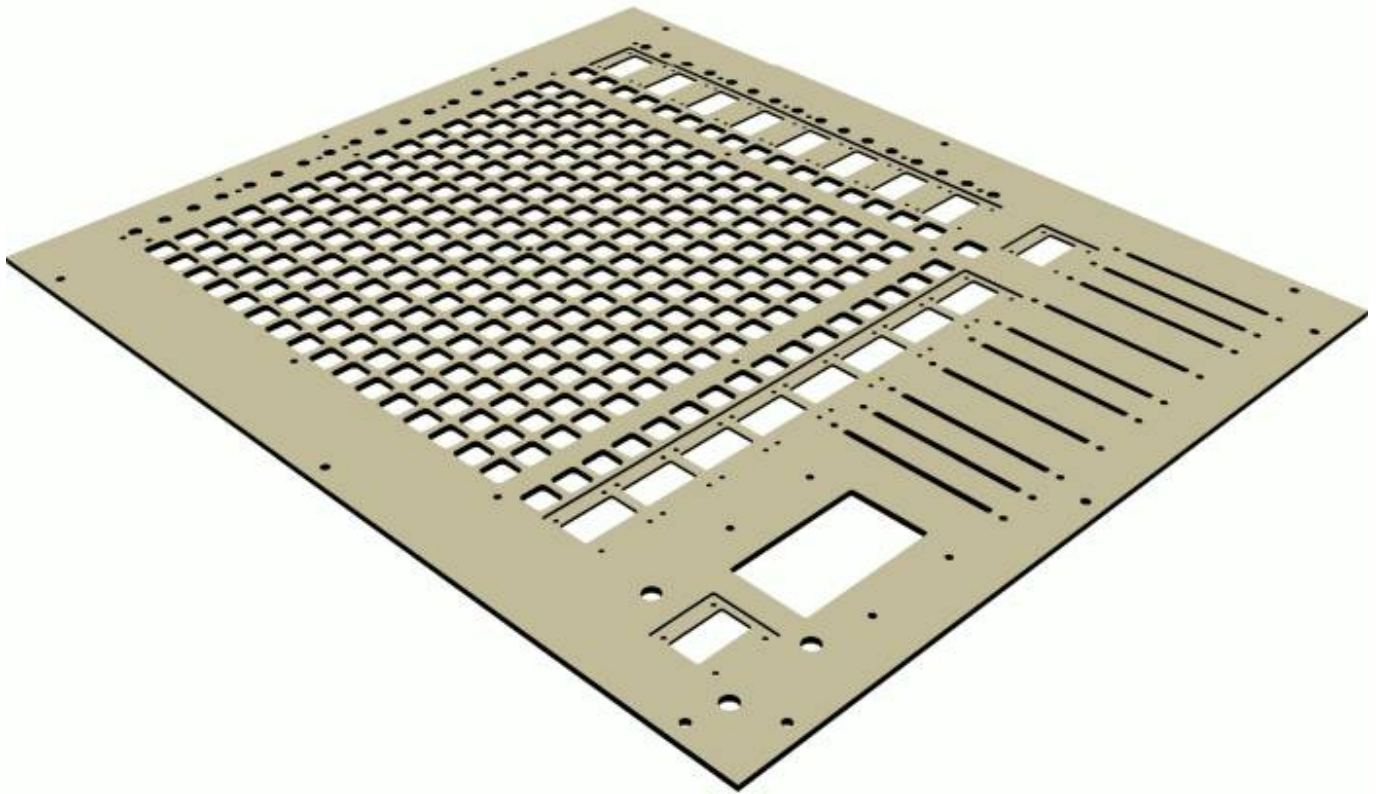

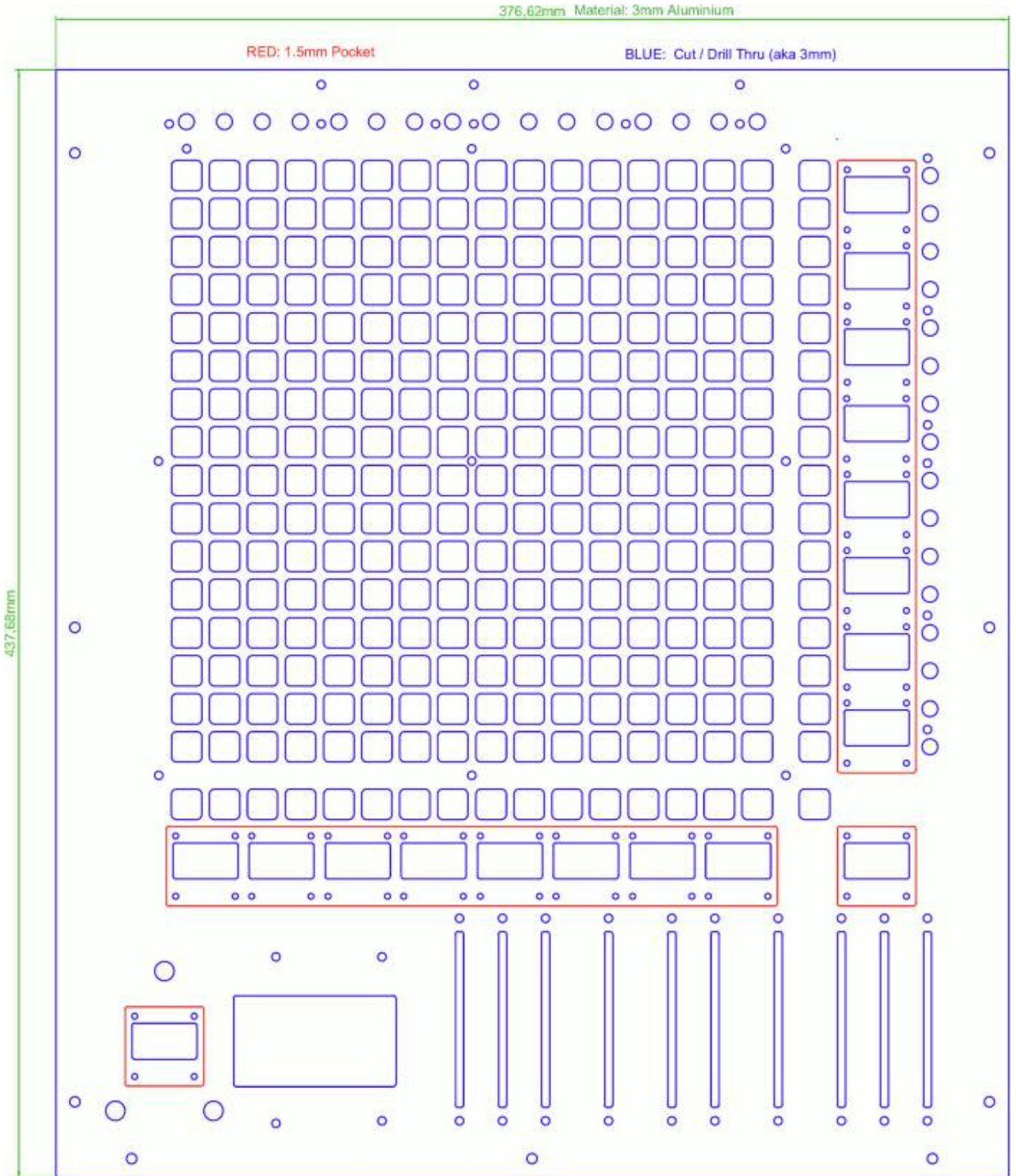

Backpanel

[tm5-backpanel.zip](#)

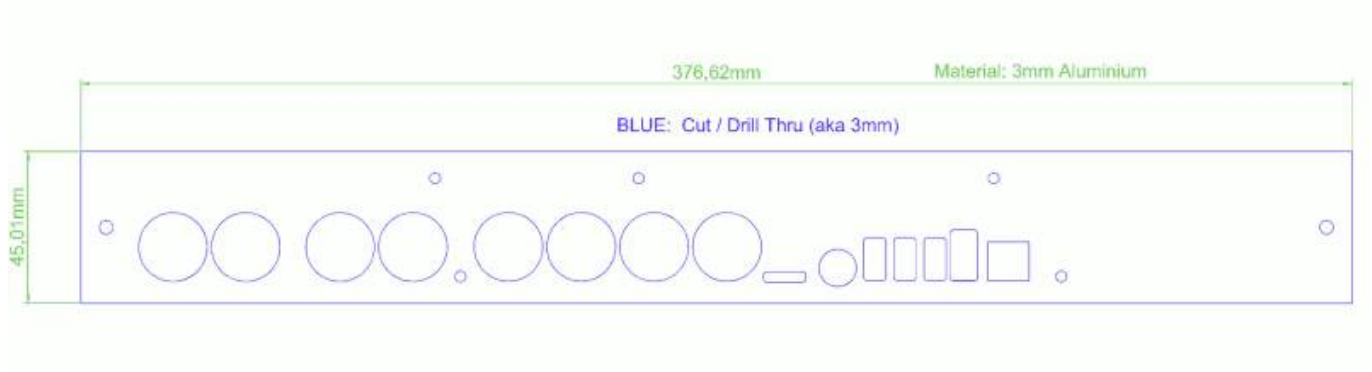

Groundpanel

[tm5-groundpanel.zip](#)

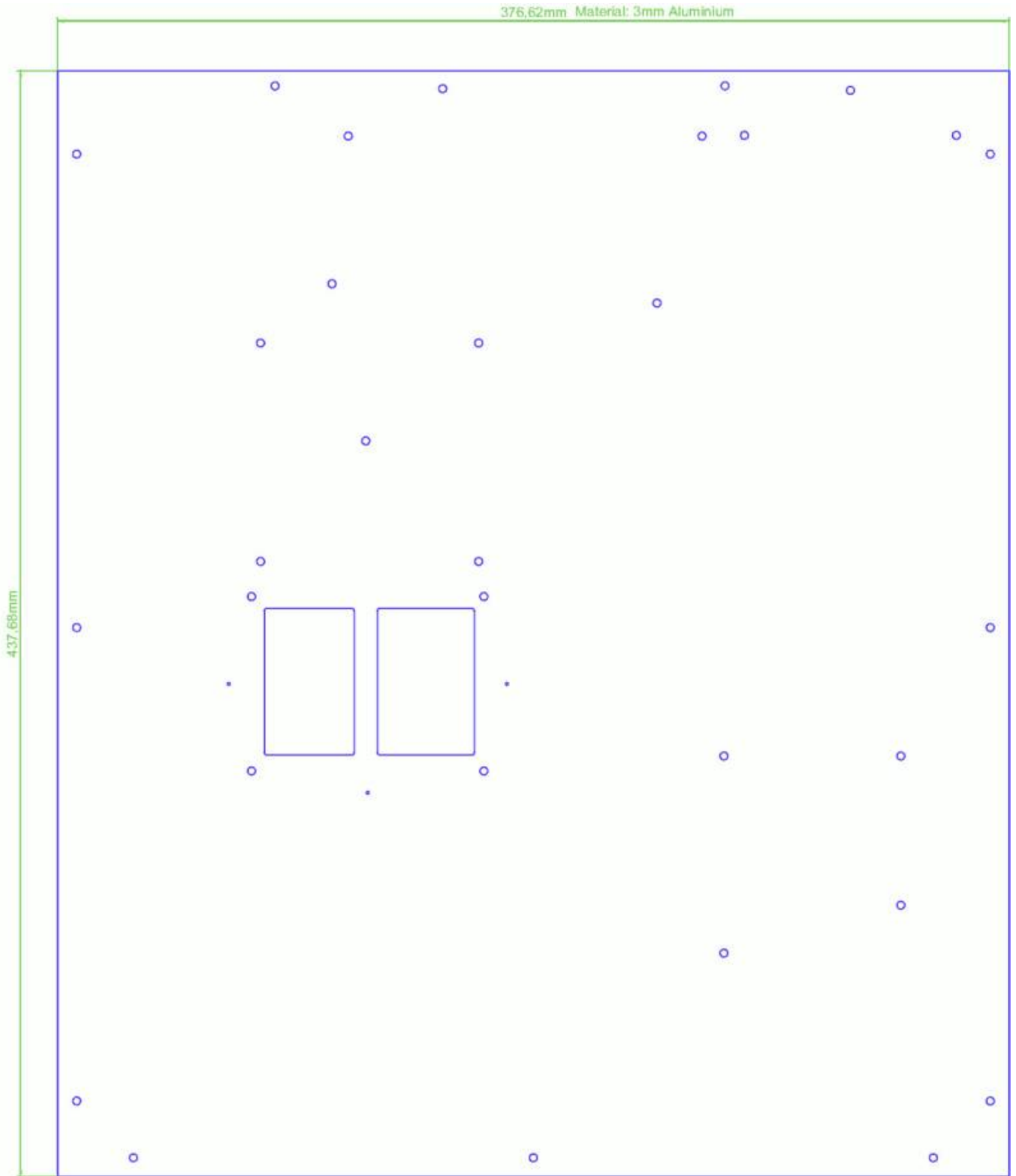

BLM-Acrylic Spacer

[Formulor \(EU\)](#)

Material: 3,00 mm Acrylglas GS Matt

Color: schwarz, opak (9H01)

File: [tm5-blm-spacer.zip](#)

Price: about 72€ incl Shipping from Germany to Austria

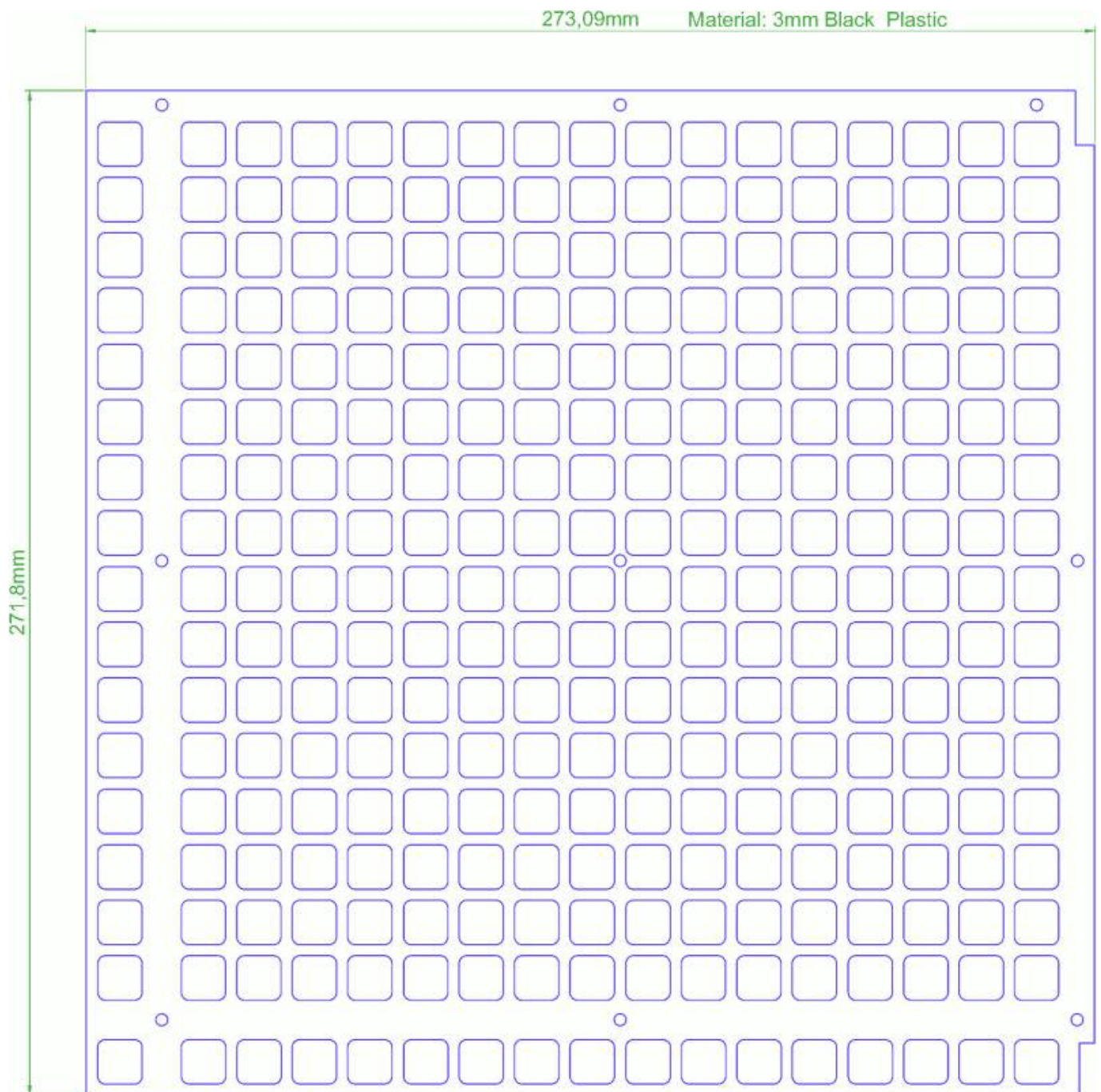

Protection-Glass for Screens

use 1mm Clear transparent Precision-Acrylic [for example Formolor \(EU\)](#)
or [ponoko \(US\)](#)

2 Pairs off Protection Screens, optimized for formular: [tm5-lcd-protection.zip](#)

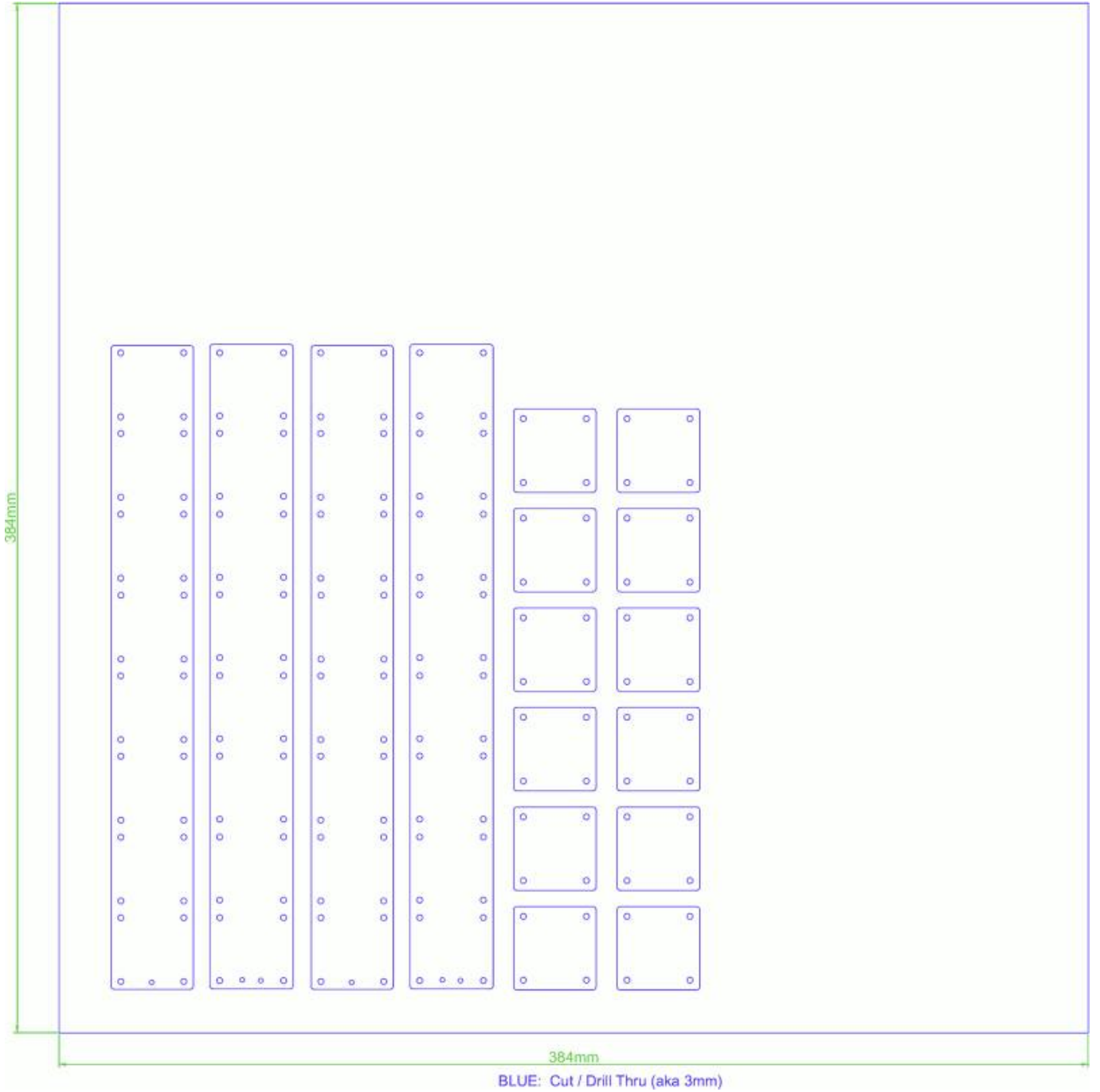

more Protection Screens, optimized for formular: [tm5-lcd-protection-mehrere.zip](https://wiki.midibox.org/doku.php?id=tm5-lcd-protection-mehrere.zip)

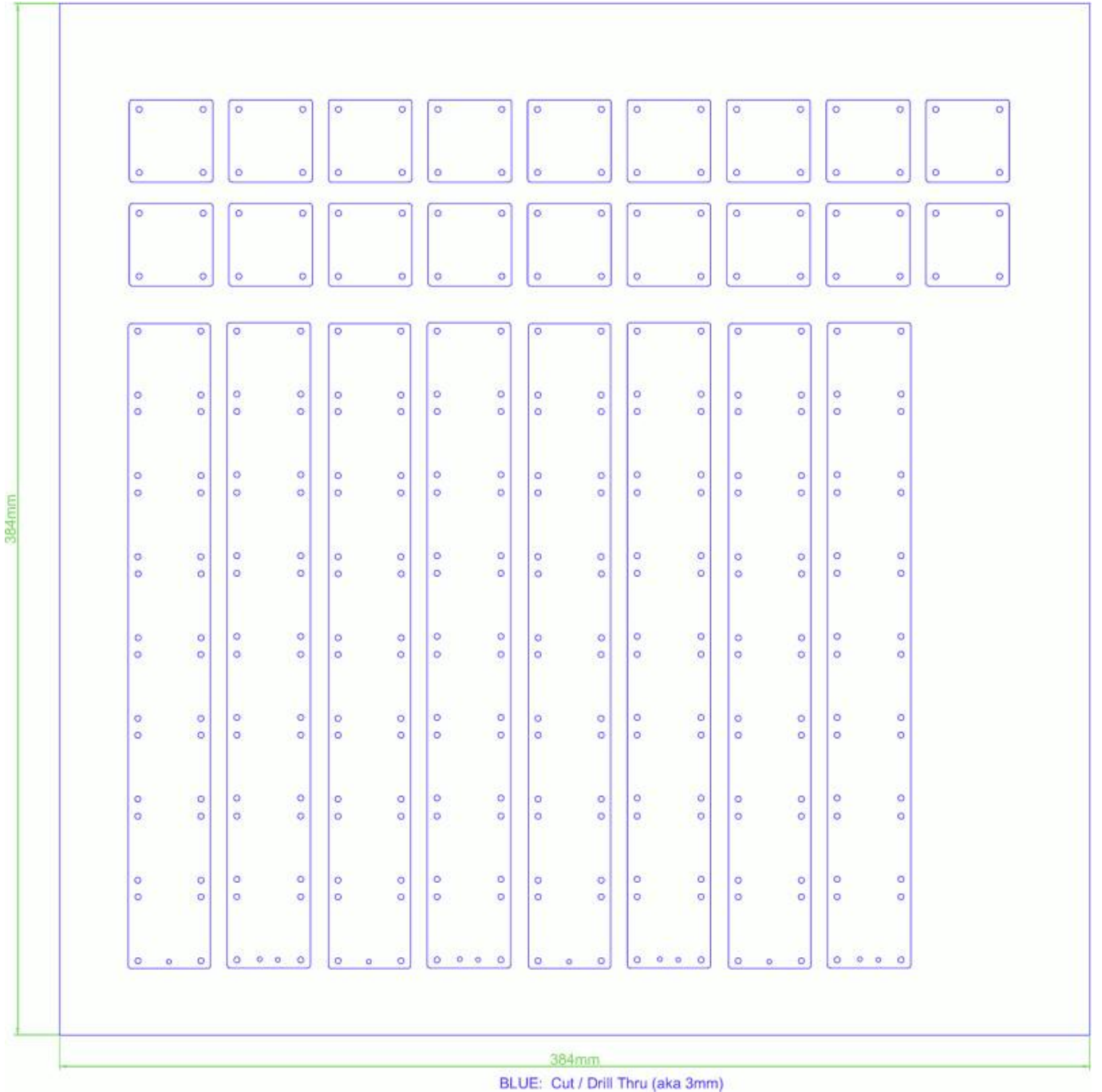



Wooden Side Panels

3x Wooden 15mm Panels, DIY or ask your local carpenter or hardwarestore

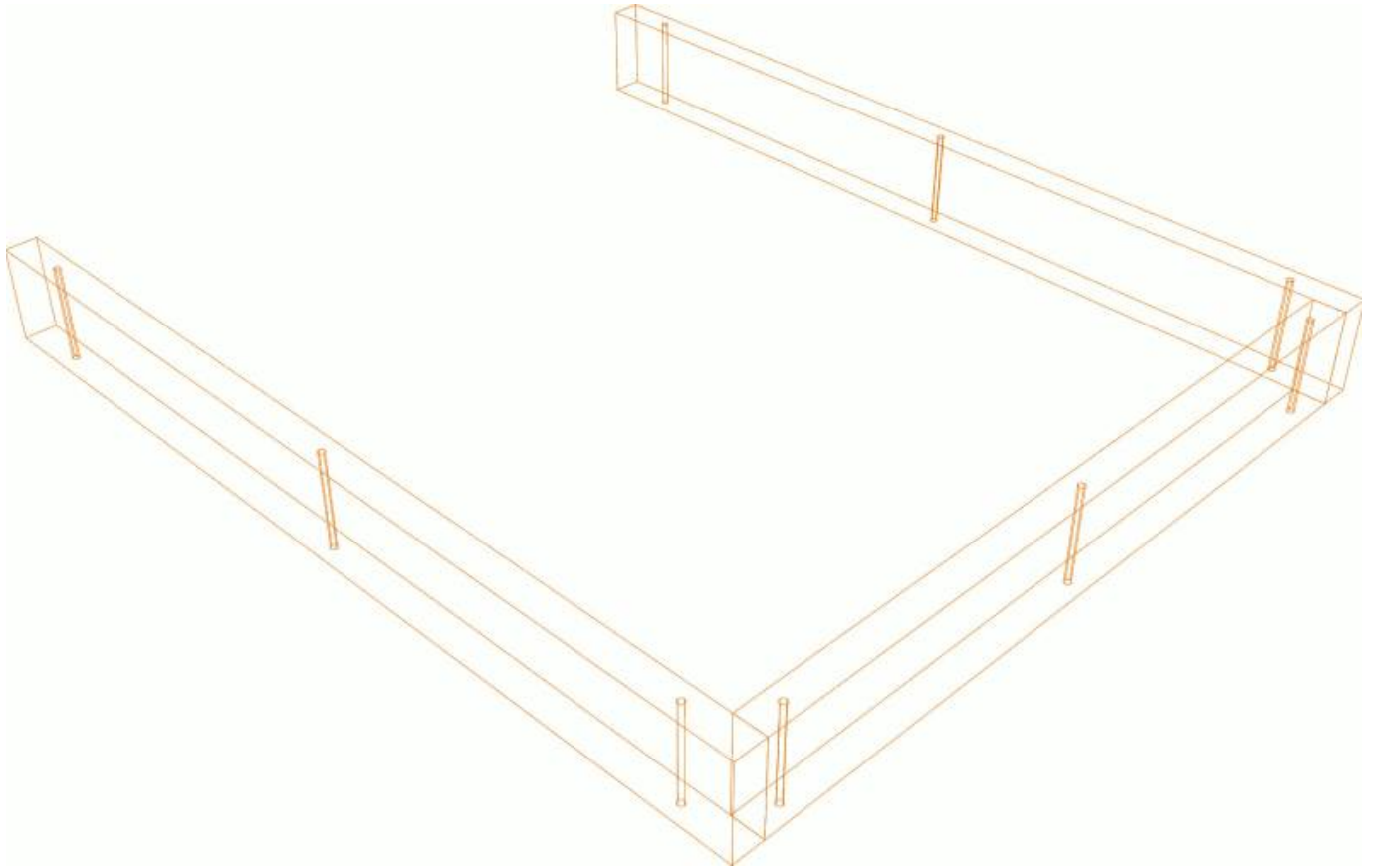

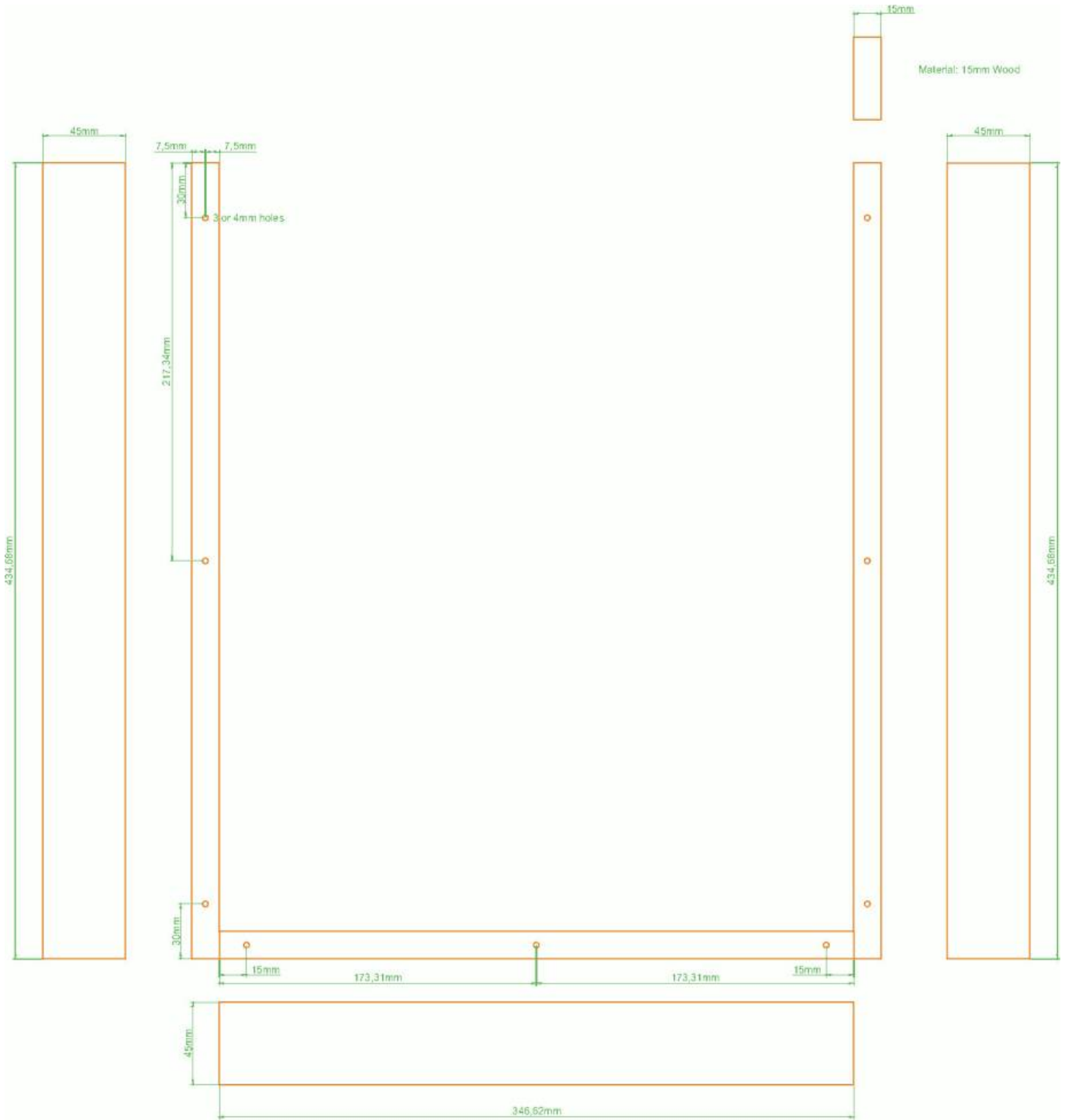

From: <https://wiki.midibox.org/> - **MIDIbox**

Permanent link: <https://wiki.midibox.org/doku.php?id=tm5-housing&rev=1674176200>

Last update: **2023/01/20 00:56**

